

Erosion and Sediment Control Guide for Land Disturbing Activities in the Auckland Region

June 2016

Guideline Document 2016/005

Incorporating Amendment 3

Reprinted August 2023

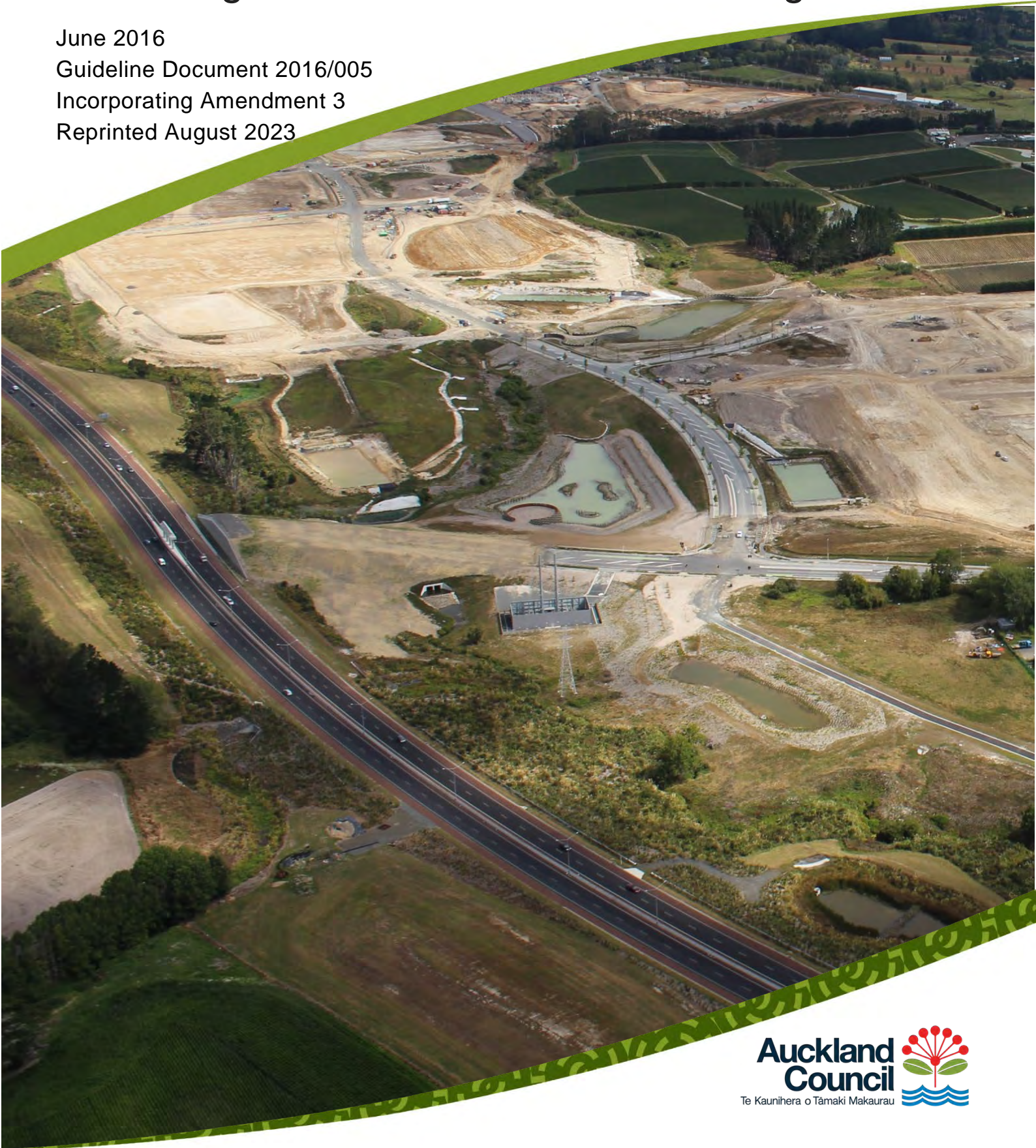

Erosion and Sediment Control Guide for Land Disturbing Activities in the Auckland Region

Incorporating Amendment 3

June 2016

Auckland Council

Guideline Document 2016/005

Reprinted August 2023 with minor text corrections

ISSN 2230-4541 (Print)

ISSN 2230-455X (Online)

ISBN 978-1-98-856464-7 (Print)

ISBN 978-1-98-856465-4 (PDF)

Reviewed and recommended for publication by:

Name: Branko Veljanovski

Position: Head of Engineering Design and Asset Management

Approved for publication by

Name: Sarah Sinclair

Position: Chief Engineer

Recommended citation:

Leersnyder, H., Bunting, K., Parsonson, M., and Stewart, C. (2023). Erosion and sediment control guide for land disturbing activities in the Auckland region. Auckland Council Guideline Document GD2016/005. Incorporating Amendment 3. Prepared by Beca Ltd and SouthernSkies Environmental for Auckland Council.

© 2023 Auckland Council, New Zealand

This publication is provided strictly subject to Auckland Council's copyright and other intellectual property rights (if any) in the publication. Users of the publication may only access, reproduce and use the publication, in a secure digital medium or hard copy, for responsible genuine non-commercial purposes relating to personal or public service, provided that the publication is only ever accurately reproduced and proper attribution of its source, publication date and authorship is attached to any use or reproduction. This publication must not be used in any way for any commercial purpose without the prior written consent of Auckland Council. The use of this publication for professional training purposes, regardless whether payable or free of charge, also requires Auckland Council's prior written consent. Auckland Council does not give any warranty whatsoever, including without limitation, as to the availability, accuracy, completeness, currency or reliability of the information or data (including third party data) made available via the publication and expressly disclaim (to the maximum extent permitted in law) all liability for any damage or loss resulting from your use of, or reliance on the publication or the information and data provided via the publication. The publication, information, and data contained within it are provided on an "as is" basis.

Amendments		
No	Date of issue	Description
1	October 2018	Minor text corrections and the following additions: <ul style="list-style-type: none">• A new chapter on coastal works• A new section on winter works• A new appendix detailing bench-testing methods.
2	October 2019	Minor text corrections.
3	August 2023	Minor text corrections.

Acknowledgements

This document was prepared with technical input from industry experts, including, but not limited to, the following individuals:

Authors

Hugh Leersnyder - Beca; Michael Parsonson - SouthernSkies Environmental; Kathleen Bunting - Beca ; Campbell Stewart - SouthernSkies Environmental

Contributors

Project management: Kate Dawkings – GHD

Additional authors: Natasha Carpenter – Auckland Council; Hannah Giess – Beca; Gregor McLean - SouthernSkies Environmental; Stuart Meakins – Laonda Advisory; Gretel Silyn Roberts – Auckland Council; Ross Winter – Beca

Graphic Design: Neelam Singh - Beca

Peer reviewer

Mike McConnell - McConnell Consultancy

Auckland Council editorial panel

Sarah Sinclair - Chief Engineer, Engineering and Technical Services

Branko Veljanovski - Engineering Design Services Manager, Engineering and Technical Services

Bridget Wild - Senior Earthworks/Streamworks Specialist, Compliance

Alex Colibaba - Senior Stormwater Specialist, Healthy Waters

Nick Vigar - Principal - Green Infrastructure and Planning, Healthy Waters

Simon Aiken - Senior Stormwater Specialist, Healthy Waters

Gretel Silyn Roberts - Principal - Technical Guidance, Engineering and Technical Services

Adam Millar - Healthy Waters Specialist, Healthy Waters

Janet MacKinnon - Technical Capability Coordinator, Engineering and Technical Services

Thanks are extended to technical experts who contributed significantly to this document including, but not limited to the following individuals: Carol Bannock (NZ Transport Agency), Tony Cain (GHD), Ed Clayton (Clayton Fordham), Aidan Cooper (Chester Consultants), Kylie Eltham (Fletcher Construction), Jason Hambrook (HEB), Brian Handyside (Erosion Management), Andy Irwin (AT), Peter Mitchell (Auckland Motorway Alliance/ Opus), Ban Najim Aldin (WSL), Richard Regan (CKL), Graeme Ridley (Ridley Dunphy), Wayne Viall (Fulton Hogan), Matthew Wallace (International Erosion Control Association), Brent Warby (Dempsey Wood Civil Ltd.), Lachlan Ward (Babington & Assoc. Ltd.). Thanks are also extended to Auckland Council staff, both past and present, who contributed to the development of the guideline. Photos were contributed by SouthernSkies, Erosion Control Ltd, Contractor's-Services LLC, Maccaferri NZ Ltd, Fletcher Construction, HEB Contractors, Hawkesbury-Nepean Catchment Management Trust, and Fulton Hogan.

This guideline has drawn on Auckland Council's guideline 'TP90 - Erosion and sediment control guidelines for land disturbing activities' and the NZ Transport Agency's 'Erosion and sediment control standard for state highway infrastructure'. The project team acknowledges in particular the NZ Transport Agency's permission to use technical information from the guideline. Other agencies and councils are acknowledged for the use of their material throughout the guideline.

Preface

What is the purpose and scope of this guideline?

This document, Erosion and Sediment Control Guide for Land Disturbing Activities in the Auckland Region, known as GD05, provides technical guidance for the selection, design and use of erosion and sediment control (ESC) practices and measures for land disturbing activities in an Auckland context.

As is explained in section A1.2, this guideline focuses on 'earthworks', where earthworks comprise:

- Disturbance of soil/ground for activities such as residential, commercial or infrastructure developments, roads and utilities, and
- Earthworks associated with quarrying (such as overburden disposal), and ancillary farming earthworks (excluding cultivation).

The primary intended audience for the guideline are designers and contractors/implementers, who construct, operate and maintain ESC measures as part of earthworks and other land disturbing activities at multiple scales. However, it also includes useful guidance for council consent processors and compliance officers, as well as developers and householders involved in earthworks activities.

GD05 is an update of TP90 – Erosion and Sediment Control Guidelines for Land Disturbing Activities in the Auckland Region (1999, and 2007 update), and supersedes that guideline. The scope or objective of this guideline update was to provide a user-friendly document that provides practical ESC methodologies and technologies that reflect the evolution of industry best practice and technological innovation.

What new inclusions and approaches are in this guideline?

The key new inclusions and approaches in this guideline (relative to TP90) are:

- A more web-friendly structure that can be viewed online and downloaded for printing
- Clear flow charts to demonstrate the steps in selecting and using the best practice option (refer Section C)
- A greater focus on practical and clear guidance for contractors and implementers of ESCs, including new photos and diagrams, installation checklists and ESC site plan/drawing examples (refer Part 2 and appendices)
- Recent ESC technologies and practices that are now considered best practice, including T-bar decants for decanting earth bunds and flocculants for sediment control; as well as clarity on the potential use of new emerging practices/innovations
- Greater emphasis on non-structural approaches to erosion control such as timing and staging of earthworks
- Guidance on ESC for activity-specific land disturbing activities such as dewatering, small sites, roads and utilities, works in the coastal marine area, winter works and farm tracking
- Additional guidance on other considerations such as sustainability, safety in design and cost benefits of ESC.

Who was consulted in the preparation of this guideline?

Extensive consultation was undertaken in the development of this guideline, including:

- Workshops with, and input from, industry through a focus group of recognised ESC practitioners, contractors, and council/government staff that regularly use the previous TP90 or other ESC guidelines
- Workshops and other consultation with Auckland Council's internal stakeholders such as its Resource Consents and Building Controls Teams
- Workshops with mana whenua.

Future revisions

Auckland Council intends to provide future revisions to this guideline periodically in response to changes in legislation, policies, technologies, national standards and feedback from industry. There is a feedback form available to download along with this document which can be sent to esc@aucklandcouncil.govt.nz.

Table of Contents

Part 1 Principles

Section A Introduction to the guideline

A1.0	Introduction	1
A1.1	Aims of the guideline	1
A1.2	Scope and application of the guideline.....	2
A1.3	How to use this guideline.....	3
A1.4	Need for this guideline	6
A1.5	How this guideline was developed	7
A1.6	Current regulatory framework for land disturbing activities	8
A1.7	Mana whenua values.....	9
A2.0	Fundamental principles of erosion and sediment control	12

Section B Erosion and control in the Auckland region

B1.0	Erosion and sedimentation in the Auckland region	15
B1.1	The erosion and sedimentation process	15
B1.2	Types of erosion	16
B1.3	Factors influencing erosion.....	18
B1.4	Calculating sediment yield.....	21

Section C Selecting and using the erosion and sediment control practices

C1.0	Selecting and using the ESC practices	23
C1.1	The ESC development process.....	23
C1.2	The treatment train approach	23
C1.3	Selecting the best management practice(s)	23
C1.4	Design of controls (preparing an ESC plan).....	27
C1.5	Construction and operation of controls.....	28
C1.6	Decommissioning of controls.....	29
C1.7	Compliance	29
C1.8	Other considerations	30

Part 2 Practices

Section D Overview of ESC practices

D1.0	Overview of ESC practices	33
D1.1	Scope of Part 2.....	33
D1.2	Current best practice methods and measures	34
D1.3	New emerging practices/innovations.....	34

Section E Erosion and control practices

E1.0	Non-structural approaches	35
-------------	--	-----------

E1.1	Minimise disturbance	35
E1.2	Stage construction	35
E1.3	Protect slopes	36
E1.4	Protect watercourses	36
E1.5	Rapidly stabilise exposed areas	37
E1.6	Consider the timing of earthworks	37
E2.0	Water management controls - for concentrated water flows	38
E2.1	'Clean water' diversion channels and bunds	38
E2.2	'Dirty water' diversion channels and bunds	43
E2.3	Contour drains (cut-offs)	47
E2.4	Check dams	50
E2.5	Pipe-drop structures and flumes	55
E2.6	Stabilised entranceways	60
E2.7	Surface roughening	65
E3.0	Soil and surface stabilisation practices	68
E3.1	Topsoiling and grass seeding	69
E3.2	Hydroseeding	73
E3.3	Turfing	76
E3.4	Mulching	78
E3.5	Geotextiles and erosion control blankets	81
Section F Sediment control practices		
F1.0	Structural approaches	90
F1.1	Sediment retention ponds	90
F1.2	Decanting earth bunds	105
F1.3	Silt fences	111
F1.4	Super silt fences	119
F1.5	Silt socks	125
F1.6	Stormwater inlet protection	130
F2.0	Coagulant and flocculant treatment	133
F2.1	General	133
F2.2	Rainfall activated treatment	136
F2.3	Batch dosing treatment	142
F2.4	Decommissioning	143
Section G Specific activities		
G1.0	Dewatering	144
G1.1	Unique nature of this activity	144

G1.2	Best practice ESC for this activity.....	144
G2.0	Small sites	147
G3.0	Roads and utilities	148
G3.1	Roads	148
G3.2	Utilities	150
G4.0	Works within a watercourse	153
G4.1	Unique nature of this activity	153
G4.2	Best practice ESC for works in a watercourse	153
G5.0	Winter earthworks	160
G5.1	Planning and management of winter works	160
G5.2	Applying for winter works approval.....	160
G6.0	Quarrying.....	163
G6.1	Unique nature of this activity	163
G6.2	Best practice ESC for this activity.....	163
G7.0	Agriculture (farm tracking)	165
G8.0	Soil binders	166
G8.1	Unique nature of this activity	166
G8.2	Best practice ESC for this activity.....	167
G9.0	Dust control.....	169
G9.1	Unique nature of this activity	169
G9.2	Best practice ESC for this activity.....	169

Section H Coastal works

H1.0	Works within the coastal environment.....	173
H1.1	Unique nature of this activity	173
H1.2	Scope of this chapter	174
H1.3	General methods that can be used to control sediment in coastal environments.....	175
H1.4	Activities which require specific control measures	178

Appendices

Appendix A1.0	References	A-1
Appendix B1.0	Glossary and abbreviations	B-3
Appendix C1.0	ESC construction quality checklists	C-9
Appendix D1.0	Recommended line types and symbols	D-41
Appendix E1.0	Site plan / drawing examples.....	E-43
Appendix F1.0	Bench testing methodology.....	F-46

Figures

Figure 1: Guideline structure and content – Part 1.....	4
Figure 2: Guideline structure and content – Part 2.....	5
Figure 3: Examples of erosion (a) and sediment discharge (b and c).....	6
Figure 4: The basic erosion process	15
Figure 5: Types of erosion.....	16
Figure 6: Auckland mean monthly rainfall (mm) 1981-2010.....	19
Figure 7: The ESC development process.....	23
Figure 8: Steps in selecting the best practice option.....	24
Figure 9: Process to select the best practice option(s) and develop an ESC Plan for development / construction	26
Figure 10: A typical earthworks construction site	31
Figure 11: Northern Motorway construction site - minimising disturbance.....	35
Figure 12: Flume installed to protect steep slope.....	36
Figure 13: Sediment discharge as a result of not protecting the watercourse	36
Figure 14: Rapid stabilisation	37
Figure 15: Clean water diversion used to isolate upper clean water flows from the works area	38
Figure 16: Turfing scraped from within the site to stabilise the perimeter bund. The perimeter bund provides both clean and dirty water control	40
Figure 17: Cross-section of clean water diversion bund	41
Figure 18: Hotmix bund diverting the motorway runoff to the catchpit.....	41
Figure 19: Cross-section of a dirty water diversion	44
Figure 20: Dirty water diversion bund directing site water to a sediment retention pond.....	45
Figure 21: Drop out pit	45
Figure 22: Contour drain.....	47
Figure 23: Contour drain installed across access track.....	47
Figure 24: Contour drain cross-section	49
Figure 25: Check dam	50
Figure 26: Check dams installed in series to act as a permanent water velocity control measure.....	50
Figure 27: Silt socks can be used as a check structure on a low gradient channel.....	51
Figure 28: Check dams installed with a spillway to direct flows over the centre of the structure. Sand bags placed directly below spillway provide a protective apron below the dam.....	52
Figure 29: Rock check dam	53
Figure 30: Flume conveying clean water over the works area.....	55
Figure 31: Geotextile lined flume	55
Figure 32: Wooden flume lined with impervious material.....	56

Figure 33: Pipe-drop structure and flumes	57
Figure 34: Pipe-drop structures conveying upper water down an exposed slope	58
Figure 35: Stabilised entranceway	60
Figure 36: Stabilised entranceway	62
Figure 37: Example of truck wash and shaker ramp	63
Figure 38: Example of a shaker ramp	63
Figure 39: Surface roughening with bulldozer	65
Figure 40: Surface roughening of a slope. Note the hollows acting as "micro" sediment traps	66
Figure 41: Surface roughening	67
Figure 42: Stabilisation via a combination of chip mulch, geotextile and aggregate.....	68
Figure 43: Grass stabilised earthworks site. Batter and building platforms	69
Figure 44: Initial grass strike - not stabilised	70
Figure 45: Approximately 40- 60% grass strike - not stabilised	70
Figure 46: Approximately 90 – 100% grass strike - stabilised.....	70
Figure 47: Loss of topsoil and grass seed after heavy rain event. Will require stabilisation and reapplication ..	72
Figure 48: Specialist application of hydroseed.....	73
Figure 49: Sports field being hydroseeded. Sediment control remains installed until an 80% grass strike has established	74
Figure 50: Recently applied hydroseed on a stormwater wetland	74
Figure 51: Same wetland one week later, grass starting to take well	75
Figure 52: Turf being placed adjacent to a stabilised swale.....	76
Figure 53: Turf used to provide instant stabilisation of the swale allowing for early commissioning of the device	77
Figure 54: Specialist application of hay mulch	78
Figure 55: Hydromulch application	79
Figure 56: Hydrohay as applied.....	79
Figure 57: Woodchip to stabilise the finished batter slope	80
Figure 58: Geotextile used to temporarily stabilise the batter face	81
Figure 59: Geotextile design – outfalls	84
Figure 60: Geotextile design – on slopes	84
Figure 61: Jute mesh	85
Figure 62: Straw blanket.....	85
Figure 63: Coconut fibre blanket used to stabilise batters while allowing grass to grow through	86
Figure 64: Bonded synthetic fibre mat used as erosion protection and medium for revegetation	87
Figure 65: Schematic of a sediment retention pond.....	91
Figure 66: A sediment retention pond cross-section	92

Figure 67: Schematic of standard T-bar design	95
Figure 68: Example of baffles	96
Figure 69: Example of a level spreader	96
Figure 70: Level spreader	97
Figure 71: Example of an anti-seep collar	97
Figure 72: Sediment retention pond for <1.5 ha catchment	98
Figure 73: Sediment retention pond for 1.5 to 3 ha catchment	99
Figure 74: Sediment retention pond for 3 to 5 ha catchment	100
Figure 75: Installation of the outlet pipe and the anti-seep collars	102
Figure 76: Level spreader across the full width of the pond	103
Figure 77: Steel strapping used to attach decant system to horizontal pipework	103
Figure 78: Decanting earth bund system and close up of T-bar dewatering device.	105
Figure 79: Decanting earth bund	106
Figure 80: Silt fence installed on edge of works	111
Figure 81: Silt fence joins. Left hand photo shows battens used to join the lengths. Right hand photo shows doubling over of fabric at end around the waratah.....	111
Figure 82: Schematic of a silt fence	114
Figure 83: Silt fence cross-section	115
Figure 84: Step-by-step installation of a silt fence.....	116
Figure 85: Contours create the same effect as returns in this case	117
Figure 86: Use of silt fence clips	117
Figure 87: Super silt fence.....	119
Figure 88: Schematic of a super silt fence	121
Figure 89: Step-by-step installation of a super silt fence.....	123
Figure 90: Silt sock used to provide control during final landscaping	125
Figure 91: Compost silt socks with returns installed	128
Figure 92: Silt sock with 1 m overlapping joint	128
Figure 93: Silt sock joined using a sleeve and pegged and secured using bailing twine with 1 m overlapping joint.....	129
Figure 94: Straw sock secured in place using stakes and bale twine; note the stakes are placed every 600 mm	129
Figure 95: 'Turkeys nest'	129
Figure 96: Silt sock used to provide control during final landscaping works	129
Figure 97: Stormwater inlet protection silt fence within a construction yard	130
Figure 98: Good use of a silt fence installed to protect a new stormwater catchpit where impounded water will not create a flooding hazard.....	131

Figure 99: Installation of a silt sock to provide some protection to the catchpit	131
Figure 100: Rainfall activated flocculant treatment device	135
Figure 101: Rainfall activated treatment system	137
Figure 102: Rainfall catchment tray	137
Figure 103: Header tank	138
Figure 104: Flocculation shed	139
Figure 105: Dewatering skip bin	145
Figure 106: Dewatering bag and pipe sock	145
Figure 107: Example of a mobile 'turkeys nest' used for dewatering	145
Figure 108: Silt fence	147
Figure 109: Progressive stabilisation in limited space	149
Figure 110: Use of stabilisation products and progressive stabilisation	149
Figure 111: Typical trenching methodology	152
Figure 112: Temporary stream diversion to allow for the installation of a new culvert	153
Figure 113: Stabilised clean water diversion and temporary culvert to divert streamflows while a new culvert is being constructed	154
Figure 114: A temporary bridge in the process of being installed	154
Figure 115: In the process of constructing a temporary crossing	155
Figure 116: Water being diverted past a construction works area	156
Figure 117: Commencement of over pumping to allow for in-stream works	156
Figure 118: Examples of temporary stream diversion installed to allow permanent culverts to be installed off- line	157
Figure 119: Diversion channel prior to plug removal	158
Figure 120: Dewatering construction area into a sediment pond	158
Figure 121: Opening up bypass channel and closing off existing one	158
Figure 122: Re-establishment of flow in original channel	158
Figure 123: Sandbag coffer dam installed to complete stormwater outfall	159
Figure 124: Decanting earth bund and diversion bund installed during a farm track construction	165
Figure 125: Forward planning and management to minimise dust provide the best options for control	169
Figure 126: Dust suppression using a water cart	169
Figure 127: Snow blowing machine to provide dust control during a liming operation	170
Figure 128: Dust suppression using soil binders/polymers	170
Figure 129: Water truck dampening down the works area	171
Figure 130: Regular wetting of the haul road	171
Figure 131: Examples of geotextile filter layer beneath a rock revetment and use of rip rap	176
Figure 132: Sheet pile coffer dam	177

Figure 133: Water draining from a sheet pile coffer dam	177
Figure 134: Use of geotextiles and coastal protection rock.....	181
Figure 135: Dune reshaping	184
Figure 136: Example of test results from bench testing	F-50

Tables

Table 1: Types of erosion and their consequences.....	16
Table 2: Soil characteristics to consider	20
Table 3: Sustainability considerations for ESC	30
Table 4: Best practice methods and measures covered by this document.....	34
Table 5: Contour drain spacing	49
Table 6: Positioning of check dams.....	52
Table 7: Sizing criteria for pipe-drop structures.....	57
Table 8: Sizing criteria for flumes	58
Table 9: Stabilised entranceway specifications	62
Table 10: Typical seed and fertiliser application rates	72
Table 11: Erosion control blankets/mats - design criteria.....	85
Table 12: Staple density	89
Table 13: Silt fence design criteria	113
Table 14: Super silt fence design criteria	120
Table 15: 300 mm diameter silt sock.....	126
Table 16: 450 mm diameter silt sock.....	127
Table 17: Specifications for compost.....	127
Table 18: Specific measures for reducing sediment plumes from different dredging activities	179
Table 19: Flocculant concentrations (aluminium) for various volumes of PAC	F-48
Table 20: Examples of test results from bench testing.....	F-49

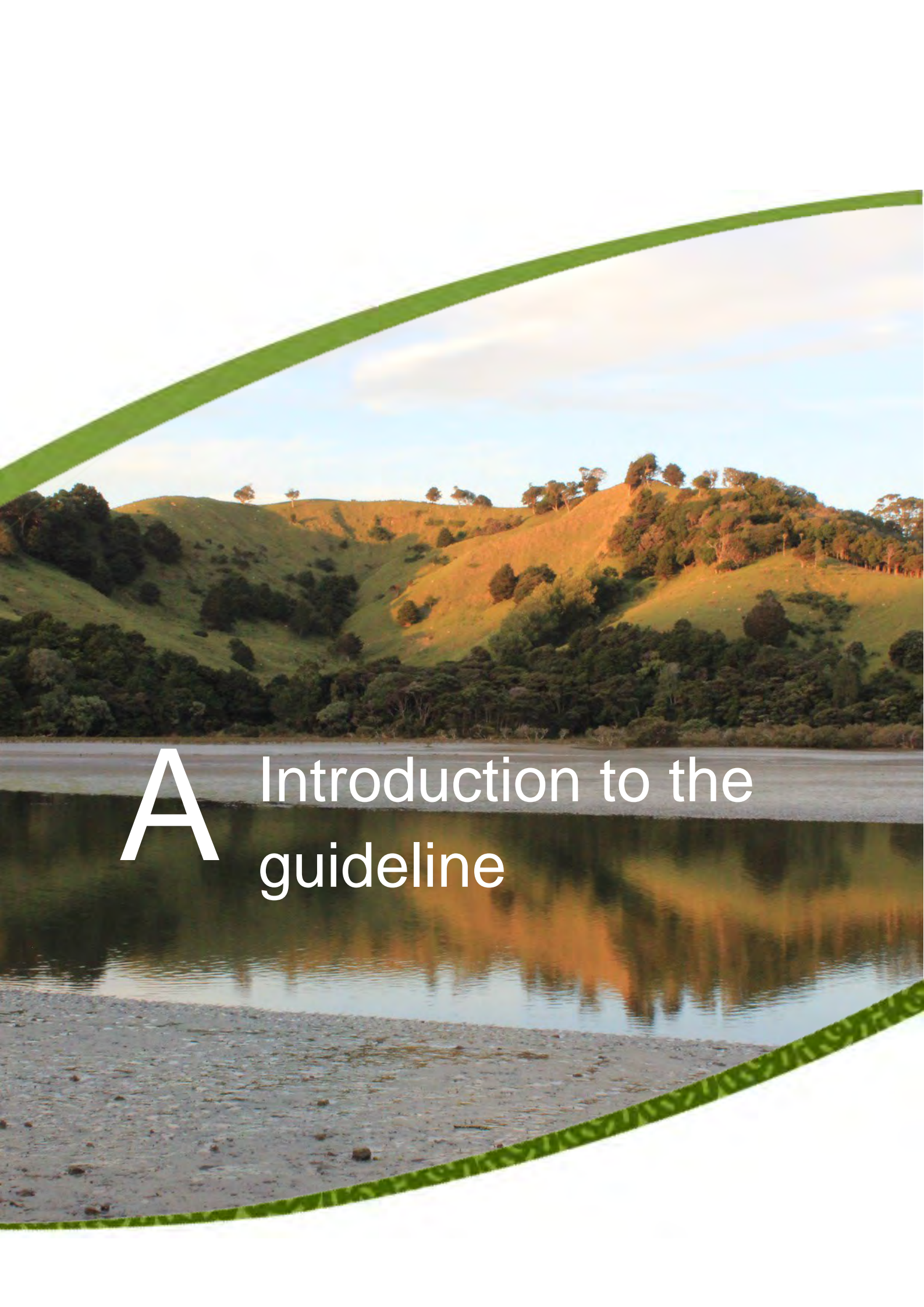

A Introduction to the
guideline

Table of Contents

A1.0	Introduction	1
A1.1	Aims of the guideline	1
A1.2	Scope and application of the guideline	2
A1.3	How to use this guideline	3
A1.4	Need for this guideline	6
A1.5	How this guideline was developed	7
A1.6	Current regulatory framework for land disturbing activities	8
A1.7	Mana whenua values	9
A1.7.1	Mana Whenua and mauri	9
A1.7.2	Application of mana whenua values	10
A2.0	Fundamental principles of erosion and sediment control	12

Figures

Figure 1:	Guideline structure and content – Part 1	4
Figure 2:	Guideline structure and content – Part 2.....	5
Figure 3:	Examples of erosion (a) and sediment discharge (b and c).....	6

A1.0 Introduction

A1.1 Aims of the guideline

A key challenge facing Auckland, identified in the Auckland Plan 2050, is how to reduce environmental degradation, of which sediment continues to be an issue. This will be further impacted through increasing urban development and climate change.

This guideline, *‘Erosion and Sediment Control Guide for Land Disturbing Activities in the Auckland Region’*, known as GD05, supports this vision by providing technical guidance for the selection, design and use of erosion and sediment control (ESC) practices and measures for a range of land disturbing activities.

This guideline’s ultimate goal is to minimise erosion, sediment discharge and sedimentation that occurs as a consequence of land disturbance. In addition, the guideline seeks to facilitate land disturbance that complies with the *Resource Management Act 1991* (RMA) (New Zealand Government, 2018), i.e. land disturbance that is necessary for:

“people and communities to provide for their social, economic, and cultural well-being and for their health and safety while –

- a) sustaining the potential of natural and physical resources (excluding minerals) to meet the reasonably foreseeable needs of future generations; and*
- b) safeguarding the life-supporting capacity of air, water, soil, and ecosystems; and*
- c) avoiding, remedying, or mitigating any adverse effects of activities on the environment.”*

(Section 5, RMA)

More specifically the guideline aims to:

- Provide an understanding of the fundamental principles of ESC
- Provide user-friendly technical advice on ESC methodologies/technologies that are current best practice, proven and practical
- Guide users on how to select and implement ESC practices and procedures during the design, construction, operation, maintenance and decommissioning phases, within the Auckland context.

This guideline updates and replaces *‘Auckland Regional Council Technical Publication TP90 Erosion and Sediment Control Guidelines for Land Disturbing Activities in the Auckland Region’* (Auckland Regional Council, 1999 and 2007), known as TP90. This second edition replaces the first edition released in 2016.

A1.2 Scope and application of the guideline

'Land disturbing activities' are defined in the Auckland Unitary Plan (Auckland Council, 2018) to include 'earthworks', 'ancillary farming earthworks' and 'ancillary forestry earthworks'.

This guideline primarily focuses on earthworks, which comprise the disturbance of soil, earth or substrate land surfaces for activities such as residential, commercial or infrastructure developments and maintenance, roads and utilities, ancillary farming earthworks, and earthworks associated with quarrying, such as overburden disposal. The guideline also addresses management of construction activities that result in the disturbance of sediment within the coastal marine area.

Earthworks include activities such as:

- Blading
- Ripping
- Boring
- Moving
- Contouring
- Placing
- Cutting
- Removing
- Drilling
- Replacing
- Excavation
- Trenching
- Filling
- Thrusting.

While many of the measures covered in the guideline are relevant to cultivation and ancillary forestry activities, those activities are not specifically addressed. Other industry best-practice guidelines apply to those activities, as required throughout the Auckland Unitary Plan.

For ease of use, the guideline does provide specific sections on:

- Roads and utilities
- Dewatering
- Works within a watercourse
- Small sites
- Farm tracking
- Overburden disposal associated with quarrying
- Works within the coastal marine area.

Section F provides specific guidance on which ESC controls are appropriate for these activities. In addition, direction is given on where other appropriate guidance can be found.

The guideline is applicable to all scales of development, from small sites (e.g. housing construction) to major developments, including permitted activities and those requiring resource consents (refer Section A1.6 for further discussion of the current regulatory framework).

The primary intended audience are designers and contractors/implementers who construct, operate and maintain ESC measures as part of their earthworks and other land disturbing activities. It also includes useful guidance for Auckland Council consent processors and compliance officers, as well as developers and householders involved in earthwork activities.

Figure 1 and Figure 2 provide an overview of the guideline's structure and content. It is split into two main parts: 'Part 1 - Principles' and 'Part 2 - Practices'. The 'Principles' section outlines fundamental principles that need to be considered when undertaking earthworks or other land disturbing activities while the 'Practices' section provides a set of controls to be used on site.

This document has been specifically prepared for use in the Auckland region. While many of the principles are common and can be used elsewhere, the technical specifications have been specifically developed for the geology, topography, receiving environments and context of Auckland. Auckland Council therefore disclaims any responsibility for use of GD05 outside of the Auckland region.

A1.3 How to use this guideline

How you should use this guideline will depend on your depth of existing knowledge of ESC principles and practices. If you are a less experienced ESC practitioner and/or have a limited knowledge of ESC principles and practices, you should follow all of the following steps:

- 1) **Scan the whole document:** To understand its aims, scope and general content and approach
- 2) **Understand the principles:** Review Part 1 – Principles (Sections A to C) to gain an appreciation of the fundamental principles of ESC, erosion and sedimentation in the Auckland region, and the overall process for selecting and using ESC practices
- 3) **Review the range of options available:** Review Part 2 – Practices (Sections D to G) to understand the range of ESC options available, and the benefits/applicability of each option
- 4) **Select the best practice option(s):** Follow the detailed steps in Section C to select the best practice option or options for your development, i.e. develop an ESC Plan
- 5) **Implement the selected option(s) or ESC Plan:** Follow the detailed steps in Section E or F to design, construct, operate, maintain and/or decommission your selected option/plan.

Note: Sites that require a resource consent will require further approval prior to implementation of the works.

If you are an experienced ESC practitioner, and are familiar with this new guideline, you should focus on steps 3 to 5 above.

Updates to this document will be made, as required, to the web version available on Auckland Council's website at aucklanddesignmanual.co.nz. Hard copies will not be sold or officially issued. It is the responsibility of the user of this guideline to ensure they download the most up-to-date version of GD05.

Part 1 - Principles



Figure 1: Guideline structure and content – Part 1

Part 2 - Practices



Figure 2: Guideline structure and content – Part 2

A1.4 Need for this guideline

As Auckland continues to grow and develop, land continues to be stripped of vegetation and laid bare during construction of subdivisions, roads, and other developments. Activities that expose bare earth can significantly increase the potential for the generation and discharge of elevated levels of sediment and other contaminants and consequently, have an adverse effect on the quality of water bodies and coastal waters (refer Figure 3).

The majority of Auckland's surface geology comprises fine clays. Clay particles are easily mobilised during rain events and take much longer to settle out than coarser sand and silt material. Since clays are more difficult to retain within standard sediment control measures, erosion control plays a significant role in effective management of land disturbance within the Auckland context.

The physical geography of the Auckland region is characterised by a network of relatively short, soft bottomed streams and rivers. The coast includes the sheltered, low-energy environments of the Waitemata, Manukau and Kaipara Harbours and the inner Hauraki Gulf. Their shallow estuarine embayments form depositional zones where fine sediment eroded from surrounding catchments settle. This makes the Auckland region particularly vulnerable to adverse impacts of erosion and sediment discharge.



Figure 3: Examples of erosion (a) and sediment discharge (b and c)

Where appropriate ESCs are not implemented, there is potential for a range of adverse effects on the social, natural, environmental, cultural and economic wellbeing of the region, including:

- Ecological values associated with direct and indirect impacts on flora and fauna on land and in adjacent freshwater and marine waterbodies, such as:
 - Smothering
 - Deterioration of habitat from discharge of sediment and pollutants and sedimentation (e.g. stream blockage, reduced light levels, weed growth)
 - Abrasion and direct impact to fish, stream insects, shellfish and other bottom-dwelling organisms
- Water quality for consumable water resources
- Aesthetic and recreational values of land and waterbodies
- Property and public utilities:
 - Blocking of pipes/drains leading to indirect flooding issues
 - Build-up of sediment in ports, marinas and navigable channels which require dredging
 - The consequential need for disposal of dredge material.

- Recreational and commercial fishing, marine farming and tourism industries
- Cultural matters of significance to mana whenua, including the mauri of water, mahinga kai, customary rights and kaitiaki initiatives.

Effective ESCs will not only avoid and/or minimise the adverse environmental effects listed above, but can also provide significant benefits and cost savings for projects, such as:

- Protection of site assets and reduced maintenance costs
- Reduced downtime and construction delays
- Meeting legislative obligations and avoidance of prosecution or other non-compliance measures
- Community and stakeholder support.

A1.5 How this guideline was developed

In preparing this guideline, a comprehensive review of recent national and international ESC research and control guidelines was carried out to acknowledge and understand current best-practice procedures and guideline approaches. This was accompanied by a gap analysis which identified gaps and issues within TP90 and other ESC guidelines. This process helped determine what should be included in this document.

Consultation was carried out through a series of workshops that drew on the technical experience and operational knowledge of a variety of external industry ESC practitioners, consultants and contractors in the Auckland region, as well as Auckland Council staff. Individual meetings were also held with Auckland Council staff involved in resource consenting and compliance for land disturbing activities. A workshop was held with mana whenua to seek feedback.

Feedback received from Auckland Council stakeholders and external industry stakeholders and practitioners was carefully considered prior to, and during, the guideline drafting and finalisation. The guideline was also peer reviewed at the scoping, draft and final stages.

The guideline development process is ongoing in terms of the education materials, and potential future updates, which will be communicated through the Auckland Design Manual webpage.

A1.6 Current regulatory framework for land disturbing activities

Land disturbing activities in New Zealand are controlled under the RMA. Its purpose is to promote the sustainable management of natural and physical resources thus placing a general duty on every person to avoid, remedy or mitigate any adverse effects of activities on the environment. Sections 9, 12, 13, 14 and 15 of the RMA restrict and regulate activities relating to land use; works in the coastal marine area; streams, rivers and lakes; and the diversion of water and discharge of sediment to the environment.

Authorisation to undertake land disturbances and their associated discharges is provided either through a rule in a district or regional plan as a permitted activity, or through resource consent. Various consents may be required for land disturbing activities. Both permitted activities and resource consents have conditions which must be complied with and are enforced by Auckland Council. This is to ensure that any environmental effects of the activity are appropriately minimised and are within the consent authority's anticipated 'envelope of environmental effects' throughout the project's duration.

In addition to the RMA, management of land disturbing activities in the Auckland region is currently subject to the provisions of the following statutory documents:

- *New Zealand Coastal Policy Statement (NZCPS)* (New Zealand Department of Conservation, 2010)
- *Hauraki Gulf Marine Park Act 2000 (HGMPA)* (applies to the catchments and coastal waters of Auckland's east coast) (New Zealand Government, 2018)
- *National Environmental Standard for Assessing and Managing Contaminants in Soil to Protect Human Health (NES:CS)* (New Zealand Government, 2011)
- *Auckland Unitary Plan, operative in part (AUP)* (Auckland Council, 2018).

As the Auckland Unitary Plan progresses through the statutory decision process, increasing weight is afforded to its provisions. The Plan replaces the regional policy statement and regional and district plans. All projects involving land disturbing activities in the Auckland region must incorporate ESC as an integral part of their development. Even small projects that do not require land use consent must still meet all relevant conditions in the relevant permitted activity rules of the ACRP:SC and the provisions of the Auckland Unitary Plan, which must be given effect to.

The need for a resource consent, or whether earthworks can be carried out as a permitted activity, should become clear once the appropriate location, area and volume of earthworks are known.

A higher level of control is required when there is a greater risk of significant adverse effects on the receiving environment as a consequence of discharge of sediment from land disturbing activities.

For earthworks that require consent, the ESC Plan will need to be submitted to Auckland Council for approval. Once approved, earthworks will often require a pre-start meeting between the plan preparer, contractor and Auckland Council compliance officer to discuss the project works.

A1.7 Mana whenua values

Consideration of mana whenua values during the earthworks phase includes two important aspects:

- An understanding of mauri
- The practical application of mana whenua values in the appropriate context.

A1.7.1 Mana Whenua and mauri

As kaitiaki, mana whenua have responsibility of ensuring that the spiritual and cultural aspects of resources are maintained for future generations. This involves the ongoing protection of mauri from damage, destruction or modification.

Mauri is a concept recognised by mana whenua as the connection between spiritual, physical and temporal realms. Loosely translated as the life force or life essence which exists within all matter, mauri sits at the very core of sustainable design for mana whenua and Te Ao Māori – the Māori worldview.

An Auckland Regional Policy statement objective is “to sustain the mauri of natural and physical resources in ways which enable provision for the social, economic and cultural wellbeing of Maori”.

This concept of mauri is recognised within the Auckland region’s regional and district plans, which mention:

- Auckland Council is committed to recognising mana whenua values associated with freshwater and enabling kaitiakitanga
- The mauri of freshwater and the relationship of mana whenua with freshwater is recognised and provided for
- The protection and restoration of the mauri and waiora of the rural and coastal environment of Tāmaki Makaurau continue to be of high priority to mana whenua of Tāmaki Makaurau.

A key concern of mana whenua is the effect on the mauri of water through the pollution of streams, rivers, catchments and harbours. This can be due to sediment entering waterways, loss of riparian margins, and the loss of native habitat to support native flora and fauna.

Degradation of freshwater quality can also affect the ability for customary harvest and manaaki due to depletion of, or in some cases the absence of, traditional mahinga kai resources. Modification or destruction of wāhi tapū and wāhi taonga is another potential effect of freshwater degradation.

The revival and enhancement of mauri should be a focus during the design and construction phases of an earthworks project through:

- A holistic approach to resource management
- Protection of habitats of edible plants and native aquatic life, which are traditional sources of food for local Māori
- Avoiding the destruction of, and/or restoring a buffer of, native vegetation alongside waterways
- Water conservation
- Avoiding mixing waters from different sources.

Examples of different states and sources of water in the Māori context are provided below. It is also important to consider these, as they relate to how water is changed through urbanisation.

- *Wai-ora*: (pure water): Water in its purest form
- *Wai-maori*: (freshwater): Ordinary water that runs free or unrestrained and has no sacred associations
- *Wai-kino*: (polluted): Where the mauri of the water has been altered through pollution or corruption and has the potential to do harm to humans
- *Wai-mate*: (dead water): Where the water has lost its mauri and is dead. It is dangerous to humans because it can cause illness or misfortune
- *Wai-tai*: (salt or water from the ocean): Which also refers to rough or angry water as in surf, waves or sea tides
- *Wai-tapu*: (sacred water): Water that is used for ritual and ceremony.

A1.7.2 Application of mana whenua values

Te Aranga Design Principles (Auckland Council, n.d.) have been developed to provide a clear process for positive engagement with mana whenua to shape our built environment and acknowledge our position as a city distinguished by the world's largest population of Māori. The Principles arise from a widely held desire to enhance mana whenua presence, visibility and participation in the design of the physical realm and are founded on intrinsic Māori cultural values. These core values have been acknowledged by mana whenua as appropriate for the Auckland region:

- *Rangatiratanga*: The right to exercise authority and self-determination within one's own iwi/hapū realm
- *Kaitiakitanga*: The exercise of guardianship by the tangata whenua of an area in accordance with tikanga Maori in relation to natural and physical resources; and includes the ethic of stewardship
- *Manaakitanga*: The ethics of holistic hospitality whereby mana whenua have inherited obligations to be the best hosts they can be
- *Wairuatanga*: The immutable spiritual connection between people and their environments
- *Kotahitanga*: Unity, cohesion and collaboration
- *Whanaungatanga*: A relationship through shared experiences and working together which provides people with a sense of belonging
- *Mātauranga*: Māori/mana whenua knowledge and understanding.

The Principles' key objective is to enhance the protection, reinstatement, development and articulation of mana whenua cultural heritage and cultural landscapes enabling all of us (mana whenua, mataawaka, tauiwi and manuhiri) to connect to and deepen our 'sense of place'.

The Principles are intended as an enabling strategic foundation for mana whenua to adopt, customise and further develop in response to local context. They also provide stakeholders and the design community with a clearer picture as to how mana whenua are likely to view, value and participate in the design and development of the built environment within their ancestral rohe.

The use of the Principles is predicated on the development of high quality durable relationships being developed between iwi/hapū, their mandated design professionals and local and central government. Robust relationships between these groups provide opportunities for unlocking a rich store of design potential.

The Principles provide guidance around culturally appropriate design processes and design responses that enhance our appreciation of the natural landscape and built environment. These same underlying principles can also help inform culturally appropriate ESC works, and examples include:

- *Mana*: The status of iwi and hapū as mana whenua is recognised and respected. For example, the principle of mana can be demonstrated by use of cultural monitoring during excavation and mana whenua inspection of environmental controls
- *Taiao*: The natural environment is protected, restored and/or enhanced. For example, avoiding the mixing of sediment-laden water into marine and freshwater receiving environments aligns with the principles of Taiao and Mauri Tu
- *Mauri Tu*: Environmental health is protected, maintained and/or enhanced. For example, the use of organic flocculants aligns with the principles of Taiao and Mauri Tu
- *Ahi kā*: Iwi/hapū have a living and enduring presence and are secure and valued within their rohe. For example, Urupā (traditional burial grounds) are commonly located near watercourses and riparian/ coastal margins. In alignment with Ahi kā, extra care should be taken when excavating near these zones
- *Mahi Toi*: Iwi/hapū narratives are captured and expressed creatively and appropriately. Enlisting mana whenua to provide cultural narrative prior to works can provide workers with an understanding of the rich cultural history and significance of the area. This aligns with Mahi Toi and Tohu
- *Tohu*: Mana whenua significant sites and cultural landscapes and landmarks are acknowledged. To align with the principles of Tohu and Mana, accidental discovery protocols should have an updated register of iwi who have mana whenua across the area surrounding a construction site. This will ensure a smooth process in the event of an accidental find.

A2.0 Fundamental principles of erosion and sediment control

An awareness of where water goes and the sensitivity of the receiving environments are fundamental to determining requirements for erosion and sediment control for land disturbing activities. The following ten fundamental principles of ESC provide best-practice guidance for minimising the adverse effects of erosion and sedimentation through the planning, construction and maintenance phases of a project. These should be followed when preparing and implementing an ESC plan.

1. Minimise disturbance

Consistent with the concepts of water sensitive design (WSD – formerly referred to as low impact design) in Auckland Council guideline GD04 (Lewis, et al., 2015), the identification and retention of existing site attributes should be incorporated into project designs, and earthworks should be minimised to the greatest practicable extent.

Land development should be fitted to land sensitivity and where possible, disturbance should avoid steeper slopes and other features such as streams and wetlands.

For any development, the total area of earthworks should be the minimum necessary to achieve the design outcome (including temporary works). The area of earthworks exposed to erosion at any given time should also be minimised through staging and progressive stabilisation.

2. Stage construction

Carrying out bulk earthworks over the whole site maximises the time and area that soil is exposed and prone to erosion. By only exposing those areas that are required for active earthworking at any one time, the duration of exposure and risk of erosion/sediment discharge can be minimised. ‘Earthworks staging’, where the site has earthworks undertaken in smaller units over time with progressive revegetation, limits erosion.

Careful planning is needed. Temporary stockpiles, access and utility service installation all need to be planned. Earthworks staging needs to be planned in conjunction with the overall construction sequencing to ensure that it accommodates the contractor’s requirements.

3. Protect slopes

If slopes are worked and require stabilisation, simple vegetative covers such as topsoiling and seeding may not be immediately effective and additional measures may be required. These are described in Section E3.0 of Part 2 - Practices. Disturbance of existing slopes should be avoided wherever possible, particularly steep slopes which have a higher risk of erosion. To minimise erosion, clean water runoff from above the site must be diverted away from the exposed slopes.

4. Protect receiving environments

Receiving environments including sensitive receiving environments¹, existing streams, watercourses and proposed drainage patterns need to be mapped. Earthworks and the removal of vegetation beside or within streams (including intermittent streams), wetlands and the coast, typically require consents from Auckland Council. Auckland Council should be consulted on these matters prior to finalising project designs.

All receiving environments, limits of disturbance and protection measures should be mapped on the ESC Plan. In addition, all practices to be used to protect new drainage channels should be marked, as well as crossings, disturbances and associated construction methods.

5. Rapidly stabilise exposed areas

Disturbed soils should be progressively stabilised with vegetation, mulch, grassing or other stabilising methods after each earthworks stage and at specific milestones within stages. Available stabilisation methods are site-specific and are described in Section E3.0 of Part 2 - Practices.

6. Install perimeter controls and diversions

Perimeter controls and diversion measures help separate 'clean water' from outside the area of disturbance from 'dirty water' that has flowed through the disturbed area. Minimising the earthworks catchment by diverting clean runoff away from the works area is a critical erosion control measure. It also reduces the size of sediment control devices required for any given works area. Perimeter and diversion controls can also retain or direct sediment-laden runoff within the site. Common controls are diversion drains and earth bunds. These are detailed in Section E2.0 of Part 2 – Practices.

7. Employ sediment retention devices

Even with the best ESC practices, earthworks will discharge sediment-laden runoff during and immediately following storms. Along with erosion control measures, sediment retention devices are needed to capture runoff so generated sediment can settle out and be retained on site. These are detailed in Section F1.0 of Part 2 – Practices.

The fine-grained nature of Auckland soils means sediment retention ponds will usually require flocculant treatment (flocculation) to maximise their efficiency. All sediment retention devices must be sized and maintained in accordance with this guideline, and must be appropriate for any given location within a site.

¹ Sensitive receiving environment are defined within Section J1 of the Auckland Unitary Plan (operative in part) as an 'area where wastewater, stormwater or other discharges have the potential to have adverse impacts on important natural or human uses or values in marine, freshwater, and terrestrial environments.' Overlays D4 – D9 within the plan identify lakes, rivers, streams and wetlands that are especially vulnerable to the adverse effects of development.

8. Get trained and develop experience

As contractors are generally responsible for installing and maintaining ESC practices, a trained and experienced contractor is an important element of an ESC Plan. Trained and experienced staff can save projects time and money through proactive construction and maintenance of ESCs. Staff should be encouraged to become experienced in ESC. Key staff should also be assigned to provide that role, so that the appropriate level of experience and supervision is available for each new project.

9. Adjust the ESC Plan as needed

An effective ESC Plan is modified as a project progresses from bulk earthworks to a fully developed site. Factors such as weather, changes to grade, altered design including drainage and formation of roads can require changes to initial ESC design.

The ESC Plan should be updated to suit site adjustments in time for the pre-construction meeting and initial inspection of installed ESCs. The Plan must also be regularly referred to and available on site. Prior to works commencement, consideration should be given as to how the site will change throughout the project, and how the ESC Plan will need to evolve to reflect this.

Note: For consented sites, adjustments to the ESC Plan may require sign-off from Auckland Council.

10. Assess and adjust your ESC measures

ESC measures need to be inspected, monitored and maintained.

Inspection and maintenance of controls is especially important prior to and following a storm event. A large or intense storm can leave ESC measures in need of repair, replacement, reinforcement or cleaning out. Maintaining and repairing measures as soon as possible after a storm event will maximise the ongoing efficiency of the measures and minimise adverse environmental effects.



B Erosion and
sedimentation in the
Auckland region

Table of Contents

B1.0	Erosion and sedimentation in the Auckland region	15
B1.1	The erosion and sedimentation process.....	15
B1.2	Types of erosion	16
B1.3	Factors influencing erosion.....	18
B1.3.1	Weather	18
B1.3.2	Topography.....	19
B1.3.3	Soil characteristics.....	20
B1.3.4	Ground cover	20
B1.3.5	Duration of soil exposure	21
B1.4	Calculating sediment yield	21
B1.4.1	Potential calculation tools	21

Figures

Figure 4:	The basic erosion process	15
Figure 5:	Types of erosion	16
Figure 6:	Auckland mean monthly rainfall (mm) 1981-2010.....	19

Tables

Table 1:	Types of erosion and their consequences.....	16
Table 2:	Soil characteristics to consider	20

B1.0 Erosion and sedimentation in the Auckland region

B1.1 The erosion and sedimentation process

Erosion is the process whereby the land surface is worn away through physical, chemical or biological processes resulting in the detachment and transport of soil particles. Sedimentation is the deposition of this eroded soil.

All development/works that involve land disturbing activities have potential to erode exposed surfaces with consequent sedimentation in the receiving environment.

To implement successful ESC on a site, it is important to understand the processes that occur during erosion and sedimentation. The basic erosion process is outlined in Figure 4 below, and includes detachment, transport and deposition of soil particles.



Figure 4: The basic erosion process

Soil particles become detached when wind, raindrop impact or flowing water exceed the soil's resistance to erosion. Soil erosion in the Auckland region is primarily caused by rainfall. Dislodged particles are transported down-slope through rain runoff and conveyed to the receiving environment where sedimentation occurs once the velocity of the runoff slows enough to allow the particles to fall out of suspension. Sedimentation is dependent on the velocity and volume of runoff, size and weight of particles, and the area available for ponding. On earthworks sites, some sediment is retained in the site's hollows and irregular surfaces. Other sediment may be retained within devices, and some residual sediment (usually clays), will discharge into the receiving environment. The key to effective ESC is to understand these processes.

Auckland's clays are difficult to retain on site once mobilised by erosion. Clay particles are small and light, and have negative electrostatic charges which repel each other, so that they do not naturally clump together to form heavier particles. For that reason, where clay soils are present, erosion control is a fundamental practice and flocculation treatment is frequently required to encourage the clay's particles to clump together. This process is detailed in Section F2 of Part 2 - Practices.

B1.2 Types of erosion

The type of erosion that may occur on a site depends on the activities carried out and the type of environment in which they occur. Figure 5 shows types of erosion processes. The main types of erosion associated with land disturbing activities in the Auckland region are outlined in Table 1.

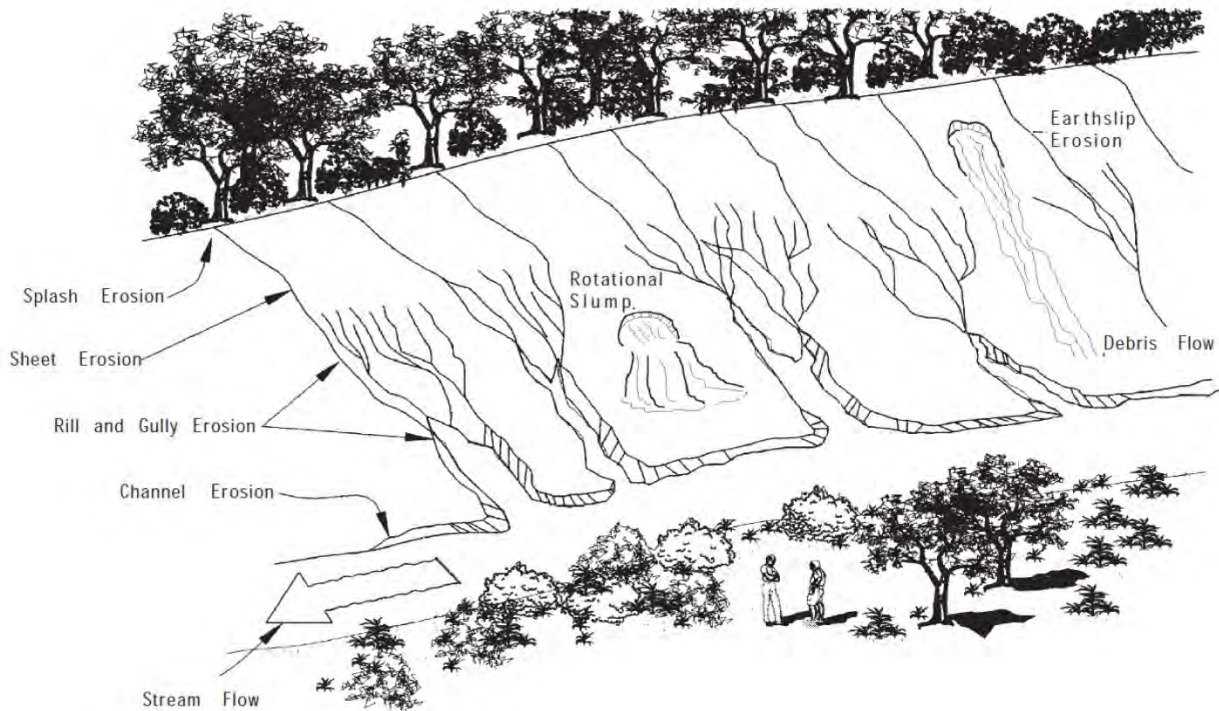

Figure 5: Types of erosion

Table 1: Types of erosion and their consequences

Type of erosion	Definition	Consequence
Splash erosion	<ul style="list-style-type: none"> When rain hits exposed soil, the soil aggregates are broken up and individual particles are displaced both vertically and horizontally. If erosion occurs on a slope, gravity will cause these particles to move down the slope. The potential for soil disturbance is increased during periods of heavy rainfall. 	<ul style="list-style-type: none"> Splash erosion makes soil particles more vulnerable to erosion by runoff and increases the amount of sediment displaced.
Sheet erosion	<ul style="list-style-type: none"> Sheet erosion is the uniform removal of soil in thin layers caused by rainfall impact and overland flow spread across the land surface. It occurs when rainfall intensity exceeds the infiltration rate of the soil and the capacity of available surface detention. It can cover large areas of sloping land and can go unnoticed for some time. 	<ul style="list-style-type: none"> If not remediated, it has the potential to gradually remove the nutrients and organic matter, and result in loss of productivity on slopes, and elevated sediment concentrations in receiving waters.

Type of erosion	Definition	Consequence
Rill erosion	<ul style="list-style-type: none"> Rill erosion is the removal of soil by runoff moving in concentrated flows along channels. Rill erosion occurs when uniform sheet flows are broken up into more concentrated flow paths. 	<ul style="list-style-type: none"> Channelisation of the flow leads to greater energy flow which is able to detach and transport larger amounts of sediment.
Gully erosion	<ul style="list-style-type: none"> Gully erosion is the removal of soils along deep (>300 mm) channels. Gullies are often distinguished from rills as being too large to step across. It occurs when soil is removed by forceful concentrated flows that form channels. The following processes contribute to gully erosion in Auckland: <ul style="list-style-type: none"> Waterfall erosion at the head of a gully Channel erosion Raindrop splash Diffuse flow from the side of a gully or from seepage Slides or mass movement within the gully. 	<ul style="list-style-type: none"> Gullies are very difficult to remediate and often require cut and fill earthworks. They may develop rapidly and cause a significant amount of erosion, particularly in sandy or pumiceous soils and poorly compacted fill.
Tunnel erosion	<ul style="list-style-type: none"> Tunnel erosion refers to the formation of long cavities beneath the ground surface, where subsurface soil has been removed by surface water while the surface soil remains intact. 	<ul style="list-style-type: none"> Eventually, tunnels reach a point where the roof collapses, resulting in potholes and the formation of erosion gullies.
Channel erosion	<ul style="list-style-type: none"> The erosion of stream channels results from conveyance of concentrated flows with high velocities, which scour the channel boundaries. Channel erosion is a natural occurrence, but is significantly accelerated by increased runoff from urban development. This leads to eroding stream banks and larger channels. 	<ul style="list-style-type: none"> Channel erosion is a significant source of sediment within watercourses and estuaries, particularly those bounded by urban catchments
Mass movement	<ul style="list-style-type: none"> Mass movement is the erosion of soil or rock by gravity-induced collapse. It is commonly initiated by groundwater pressure following heavy rain, but can also be caused by stream bank or earthworks undercutting at the base of a slope. Movement can both be rapid and near instantaneous (landslides, avalanches, debris flows) or slow and intermittent (earthflows and slumps). Mass movement is often noted following the removal of vegetation from critical slopes associated with land clearance. 	<ul style="list-style-type: none"> Mass movement can cause major problems on earthworks sites and lead to considerable sedimentation. Geotechnical investigations and design are required to avoid mass movement during and after construction.

Type of erosion	Definition	Consequence
Wind erosion	<ul style="list-style-type: none"> • Wind erosion is the process where soil particles are detached from the land surface and transported by wind. • The effect of the process varies depending on factors such as particle size and composition. • There are three ways that soil moves due to wind: <ul style="list-style-type: none"> ○ Creep: Larger particles that are not able to be suspended may roll along the surface ○ Saltation: Wind-blown particles skip or bounce along the surface detaching more particles where they land ○ Suspension: Fine particles are detached by saltation and lifted and carried away as dust. 	<ul style="list-style-type: none"> • Wind-blown sediments (dust) from earthworks sites can be a significant form of air pollution. • Stabilising exposed surfaces is the only long-term means of preventing wind erosion.

B1.3 Factors influencing erosion

Primary factors influencing the amount of soil loss from earthworks sites are:

- Weather (including climate change)
- Topography
- Soil characteristics
- Ground cover
- Duration of soil exposure
- Rainfall intensity.

These factors should be considered during the initial planning stages of earthworks to effectively control and reduce the amount of erosion that may occur.

B1.3.1 Weather

Weather is an important factor to consider when planning and implementing earthworks. Rainfall and wind have the potential to initiate erosive processes and cause significant erosion and sedimentation issues.

Rainfall intensity, duration and frequency are the main factors that determine the volume of runoff at a given site. The potential for soil particles to become detached and transported becomes greater as these factors increase.

Most rainfall in the Auckland region occurs throughout the winter season (May - September), as indicated in Figure 6. During this time, careful consideration should be taken when designing control measures to accommodate the increased rainfall volumes. Also, as climate determines the extent and growth rate of vegetation, Auckland's annual rainfall and temperature patterns need to be taken into account when scheduling revegetation so that ground cover has the best chance of establishing.

While potential erosion is likely to be more significant during higher rainfall months, erosive processes can occur at any time and best practice erosion control must still be followed throughout the year. High intensity rainfall events can result in significant erosion and can be experienced at any time of the year, particularly in late summer and autumn, and may be expected to increase with climate change.

As a result of climate change, there are also likely to be seasonal and geographical variations in temperatures and rainfall patterns across the Auckland region, as well as changes to soil moisture and the coastal environments. These changes will also mean more frequent severe weather such as intense rainfall and drought periods (Pearce, et al., 2017). Careful design is needed to accommodate potential impacts associated with these events.

Rainfall also varies spatially across the Auckland region. Further details on this spatial variation are available in the design rainfall maps appended to TP108 *Guidelines for Stormwater Runoff Modelling in the Auckland Region* (Auckland Regional Council, 1999) (or its successor).

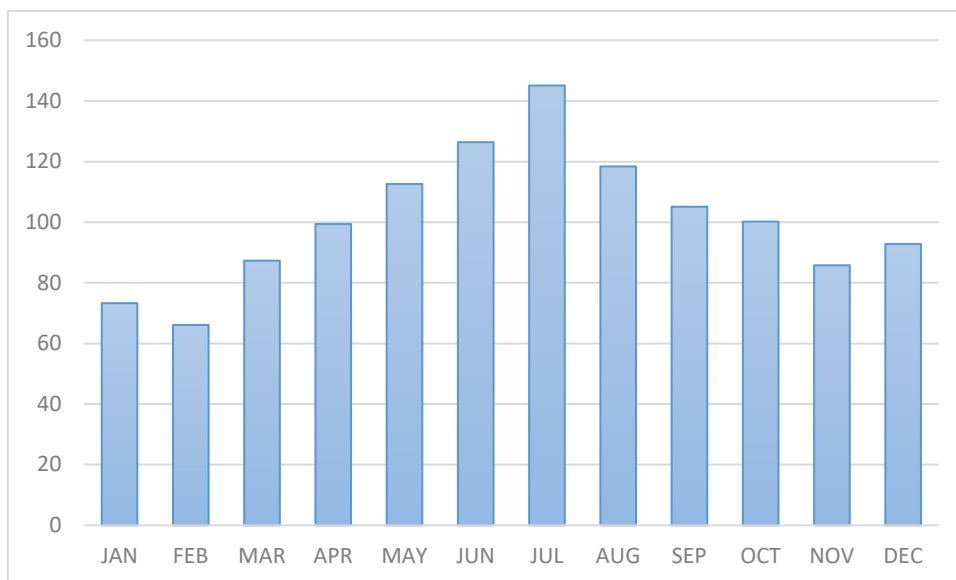

Figure 6: Auckland mean monthly rainfall (mm) 1981-2010

B1.3.2 Topography

Slope length and angle have a significant role in determining the velocity of runoff. Increasing slope gradient increases potential flow velocity. Increasing slope length increases the catchment area of the slope and thus, increases the potential for flows to concentrate and the volume and velocity flows. As the slope of a site steepens and lengthens, the potential for soil erosion increases, particularly rill and gully erosion. As flows pass further down a slope, so the potential for erosion increases. Therefore, the lower sections of slopes typically experience more significant erosion than the upper sections.

B1.3.3 Soil characteristics

Soil erodibility refers to the susceptibility of soil particles to become detached by erosive forces. It can be determined by the combination of soil characteristics listed in Table 2.

Table 2: Soil characteristics to consider

Soil characteristic	Explanation
Texture	<ul style="list-style-type: none"> • Soil texture refers to the particle sizes and their relative proportions that make up a particular soil. The three major classes of soil particles are sand, silt and clay. • Soils that contain higher proportions of fine sand and silts are considered more erodible. • Erodibility decreases with clay content, as clay binds soil particles together. However, while clay is more resistant to erosion, once eroded, it is far more difficult to settle out and retain on site.
Organic matter content	<ul style="list-style-type: none"> • Organic matter refers to the plant and animal litter component within soil. • It's primarily found within topsoil and can reduce runoff and erosion potential as it often improves soil structure and increases permeability, water holding capacity and soil fertility.
Structure	<ul style="list-style-type: none"> • Soil structure refers to the arrangement of particles into aggregates, and includes the size, shape and distribution of pores within and between the aggregate. • When soil is compacted, water tends to run off rather than infiltrate, increasing the potential for erosion.
Soil permeability and porosity	<ul style="list-style-type: none"> • Soil permeability refers to the ability of the soil to allow air and water to move through the soil. • Soil porosity refers to the fraction of the total soil volume that is taken up by pore space. • Soils of high porosity generate less runoff than soils with a low permeability. • Organic matter and the associated biological activity in soils play an important role in maintaining porosity.
Soil moisture	<ul style="list-style-type: none"> • During summer periods, evaporation can lead to higher rates of wind erosion when soil moisture is low. • In those conditions, soil particles are less bound by moisture and are more easily windborne, particularly when disturbed by construction vehicles and machinery.

B1.3.4 Ground cover

Ground cover helps control a site's erosion potential. Ground cover such as vegetation and impervious surfaces provide protection from erosive forces of raindrops, wind and flowing water.

On a vegetated site, the potential for erosion is greatly reduced as the ground cover provides instant protection by reducing the impact of rainfall, dispersing flows, slowing down runoff and maintaining the soil's ability to absorb water.

B1.3.5 Duration of soil exposure

The duration of soil exposure to potential erosion is complex, but in simple terms, the longer an earthworks site is exposed, the greater the chance that it will be subject to rainfall. In Auckland, working from May to September presents a higher likelihood of experiencing more frequent rainfall and less opportunity for ground surfaces to dry between rainfall events, which in turn increases the total amount of runoff that occurs in any given event.

Minimising the duration of works should minimise rainfall experienced during a project. Staging works to minimise the area of ground exposed to erosion at any one time is an appropriate measure to minimise the erosion potential from high intensity rainfall events. A balance is always required between the overall duration of earthworks and the staging of works.

B1.4 Calculating sediment yield

The amount of sediment discharged from a catchment is the catchment's sediment yield (generally measured in tonnes/hectare/year). Rainfall, soil erodibility, slope, ground cover and duration of soil exposure combine to influence the amount of sediment that may be generated from an earthworks' site and consequently, the amount of sediment that must be captured by sediment control devices to adequately minimise adverse effects on the receiving environment.

The site's topography and the area of bare earth influences the sediment yield, and thereby determines potential hotspots where ESC is required.

The scale of a sediment yield assessment needs to reflect the scale of the proposed earthworks. Careful consideration should be given to the practical benefit of undertaking a sediment yield assessment and if deemed necessary, the methodology to be used. Typically, the larger the earthworks proposed and the higher the sensitivity of the receiving environment, the more beneficial a sediment yield assessment will be.

B1.4.1 Potential calculation tools

The Universal Soil Loss Equation is a tool that has been used in New Zealand to estimate the potential annual soil loss on a slope based on rainfall pattern, soil type, topography, vegetation cover and management practices. The equation can help identify the scale of potential effects on receiving environments, and the risk associated with those sedimentation effects. (Note: It will not help choose the most appropriate ESC practice/s. It is only appropriate to identify those areas of a site with a higher sediment generating potential.)

A more recent advance in the field of estimating sediment yield has been the introduction of computer models. One such model used in recent large-scale roading projects in the Auckland region has been the Groundwater Loading Effects of Agricultural Management Systems (GLEAMS) model. This is a physically-based model developed for continuous simulation of surface runoff and sediment losses on a field-scale.

The model inputs are similar to the Universal Soil Loss Equation, including land cover, soil type and slope in conjunction with a long-term climate record and other hydrological parameters. The GLEAMS model has been used to predict sediment yields with and without the inclusion of sediment control. It can be used to predict sediment yields for rainfall events with different recurrence intervals. The outputs assist in quantifying the downstream ecological effects. Further details on the GLEAMS model are available at: <http://tools.envirolink.govt.nz/dsss/groundwater-loading-effects-of-agricultural-management-systems>.

Other models include:

- CLUES (Catchment Land Use for Environmental Sustainability), which can predict mean annual farm, catchment and regional sediment yield
- SEDNET, a model that constructs sediment and nutrient budgets for regional scale river networks.



C

Selecting and using the erosion and sediment control practices

Table of Contents

C1.0	Selecting and using the ESC practices	23
C1.1	The ESC development process	23
C1.2	The treatment train approach	23
C1.3	Selecting the best management practice(s)	23
C1.3.1	Step 1: Site assessment	24
C1.3.2	Step 2: Consider the construction methodology (for the overall development)	24
C1.3.3	Step 3: Choose the ESCs	25
C1.4	Design of controls (preparing an ESC plan)	27
C1.5	Construction and operation of controls	28
C1.6	Decommissioning of controls	29
C1.7	Compliance	29
C1.8	Other considerations	30
C1.8.1	Sustainability	30
C1.8.2	Safety	31
C1.8.3	Cost benefits of ESC	32
C1.8.4	Ancillary construction effects	32

Figures

Figure 7: The ESC development process	23
Figure 8: Steps in selecting the best practice option	24
Figure 9: Process to select the best practice option(s) and develop an ESC Plan for development / construction	26
Figure 10: A typical earthworks construction site	31

Tables

Table 3: Sustainability considerations for ESC	30
--	----

C1.0 Selecting and using the ESC practices

C1.1 The ESC development process

This section assists with the selection of the most appropriate ESC measures for a given site, and the development of an overall Site ESC Plan. To establish the management of the site from pre-start to completion of works, the process should follow the steps listed in Figure 7:

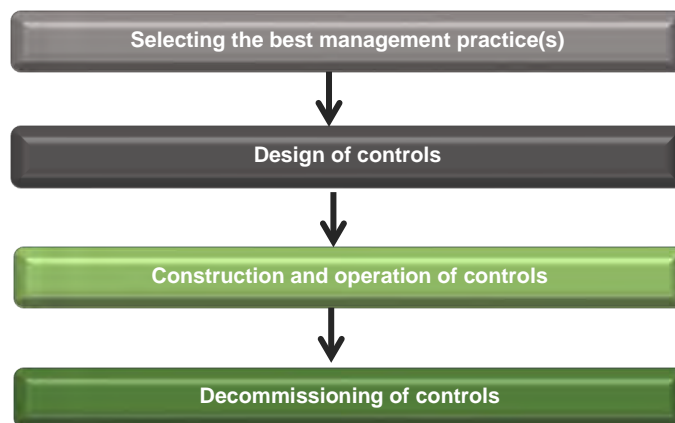

Figure 7: The ESC development process

C1.2 The treatment train approach

A 'treatment train' consists of multiple best-management practices, operating in series and linked to improve the overall efficiency of contaminant (including sediment) removal. ESC measures should link to form the treatment train as each measure has a specific role. This approach can be a combination of structural (e.g. sediment retention ponds, perimeter controls) and non-structural (earthwork season, staging) practices.

This treatment train approach should be considered during the project's early planning phases and followed through to project completion. The following sections detail how to select appropriate tools to ensure that this approach occurs.

C1.3 Selecting the best management practice(s)

ESCs are a suite of management practices that can be implemented to minimise sediment discharge during land disturbing activities. This section outlines key considerations and strategies that should be used to determine the most appropriate ESCs for a site. It addresses how the key principles should be implemented throughout a project from the initial site assessment stage through to implementation and decommissioning of controls. Figure 8 shows the three main steps involved when choosing and implementing ESCs for a site.

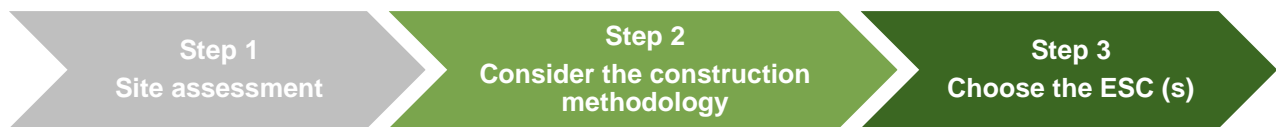

Figure 8: Steps in selecting the best practice option

C1.3.1 Step 1: Site assessment

Best practice management should be considered in every environment using a minimum level of control. However, there are some particularly sensitive environments where additional controls may be required. An initial assessment of the area will identify the environmental values of, and risks to, the surrounding environment to determine if additional controls are needed beyond typical requirements.

This assessment should address the following (as a minimum):

- Land type, including:
 - Topography
 - Soil type
 - Hydrological patterns
 - Climatic conditions
 - Contamination
 - Groundcover
- Sensitivity of the receiving environment
- Community values and concerns.

An assessment of the regulatory requirements should be carried out at the same time to determine whether the activity requires a resource consent. If the activity does require a consent, this needs to be sought at the project's early stages and should be undertaken in consultation with Auckland Council.

C1.3.2 Step 2: Consider the construction methodology (for the overall development)

ESC should be considered during the project's initial development planning (as well as its detailed design stage) to minimise the areal extent of earthworks and therefore, the area exposed to erosion and generation of sediment discharges. Designers should design the project accordingly. When land development is matched to land sensitivity, areas prone to erosion can be avoided, reducing the number and size of ESCs required. For example, careful route selection or location of access and building platforms can result in a significant reduction in potential erosion and sediment discharge, with a corresponding reduction in the risk of sedimentation within the receiving environment.

Once the design has been finalised, construction methodology can further avoid or reduce the need for ESCs. Construction methodology outlines how the work will be undertaken in accordance with the key principles listed in Section A2.0.

By incorporating non-structural ESC principles at the start, the need for structural ESC practices on site can be reduced. Preventing erosion is more cost efficient, easier to implement and more effective than capturing sediment within a site. Construction methodology should address what types of practices are required and where they are to be located.

C1.3.3 Step 3: Choose the ESCs

Once a site assessment has been carried out and construction methodology agreed, the extent of ESC practices required should be clear.

Prior to selecting ESCs, the following four fundamental principles of ESC should be considered to prevent erosion, (refer Section A2.0):

- Minimise disturbance
- Stage construction
- Protect steep slopes
- Protect watercourses (and other sensitive features).

Once these key principles have been considered, suitable ESCs can be chosen to manage any potential erosion and sediment that cannot be avoided.

Practices that manage erosion should be addressed first, followed by management of any sediment discharge to ensure that the number and size of sediment control devices is minimised. Figure 9 is designed to help you to choose the best management practices for a site. While the exact choice of ESCs will ultimately depend on an individual site's constraints, this flow chart acts as a guide to recommend which control is generally the most appropriate based on industry experience.

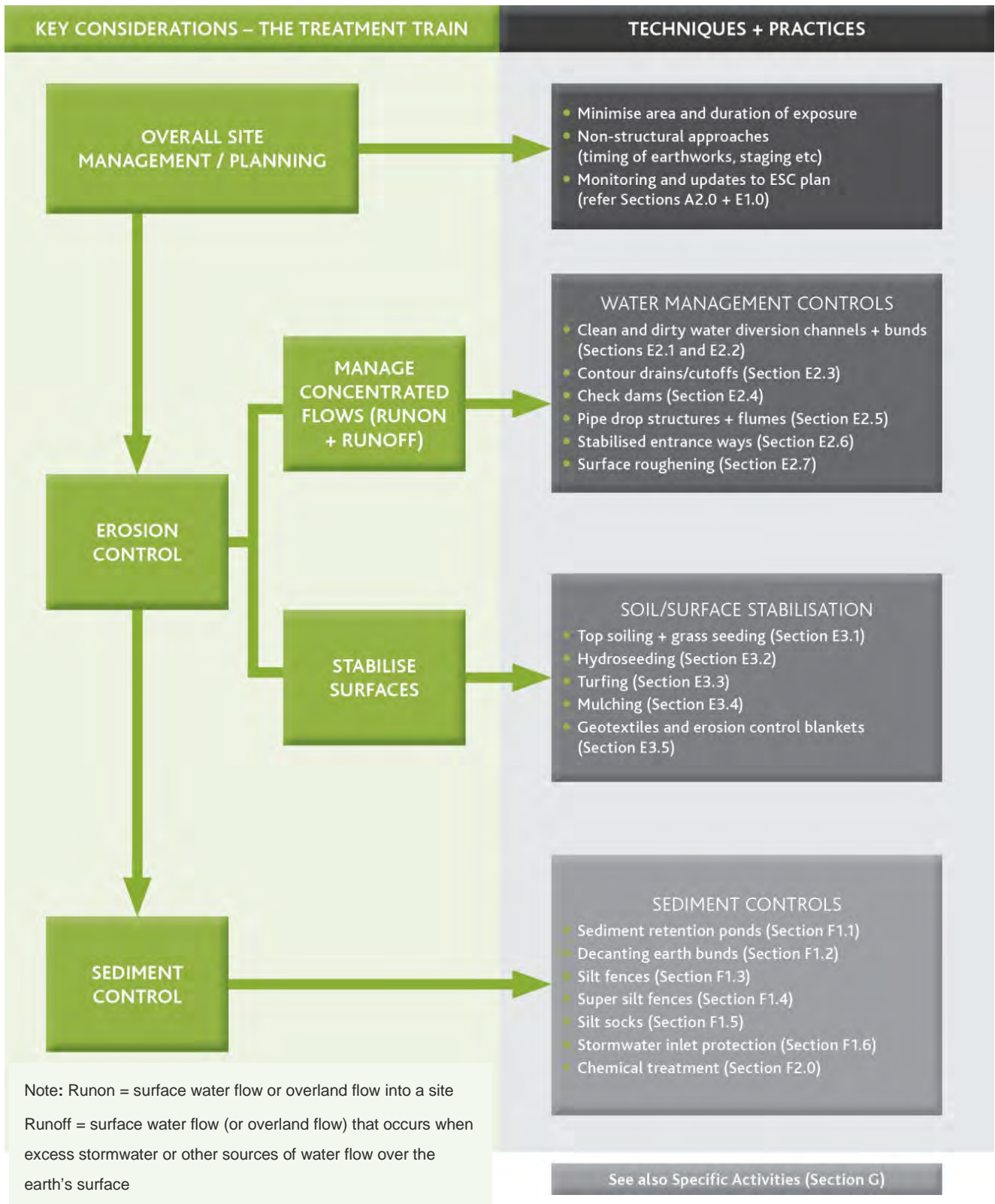

Figure 9: Process to select the best practice option(s) and develop an ESC Plan for development / construction

C1.4 Design of controls (preparing an ESC plan)

The ESC plan process outlines the process for a site that requires a resource consent; however, the same principles should be considered for earthworks that comprise a permitted activity.

The plan needs to convey sufficient certainty to Auckland Council that the environmental effects of the earthworks can be managed within an appropriate 'envelope of effects' while providing flexibility for the contractor to modify their approach based on the practical site constraints. This will typically require an iterative process where the plan is refined based on discussions between the plan preparer, Auckland Council and contractor. The plan needs to be easily understood with commonly recognised symbols to denote the different practices to be used (please refer to the recommended line types and symbols in Appendix D and the ESC site plan/drawing examples, in Appendix E for further guidance).

Ultimately, the ESC Plan is the tool used to ensure that all the elements identified in the site assessment and construction methodology are taken into consideration and managed accordingly.

An ESC management plan should include a site plan/drawing(s) in addition to diagrams, drawings, earthworks (cut/fill) plans, and/or narrative that details the set of practices that will be used. Please refer to Appendix E for ESC site plan/drawing examples and recommended information to include.

For larger sites, the ESC management plan text should include the following (if not already shown on the ESC site plan/drawing):

- Site description including soil, slope (contours at an interval suitable for design), and total site area
- Detailed programme of works which identifies:
 - Details of the construction period/dates/timeframes/methodologies
 - Details of any staging plans for disturbed areas
 - The area of disturbance at each stage, including consideration of progressive stabilisation and minimisation of exposed soil
 - Length of exposed roads, tracks and trenches
 - Cut/fill volume details
 - Location and volume details of any stockpiles
 - Extent and type of vegetation to be removed or planted.
- Drawings and description of ESC practices to be implemented
- Details of the receiving environment that the project drains into and the pathways and distance to these
- The methodology for implementing these control measures (considering any staging of the works)
- A programme detailing the frequency and methodology of any inspections, monitoring and maintenance of measures (including checks proposed during rainfall events)
- Emergency procedures to be implemented if there is an accidental untreated sediment discharge to surface water.

C1.5 Construction and operation of controls

ESCs must be implemented prior to other site earthworks commencing and understood by all relevant parties involved in the project. An appropriately experienced person should be appointed to oversee the implementation of the plan in addition to monitoring and maintenance of devices.

(Note: All perimeter controls and the main sediment retention devices must be installed prior to significant earthworks commencing.)

The contractor should take the following steps on site to ensure the plan is implemented and maintained:

Step 1: Define the work area in which earthworks are to occur

Land disturbance limits should be clearly marked out on site with buffer zones to delineate areas to be protected. A site access point should be identified that restricts vehicle movement to designated tracks. (Note: This will most likely require specific measures to ensure this area does not become a source of sediment.)

Step 2: Implement perimeter erosion controls

All clean-water diversions to be on site should be implemented first to minimise the site catchment. As-built plans must be prepared for these devices to confirm compliance with the guideline requirements.

Step 3: Implement primary sediment retention controls

The primary sediment retention controls should then be installed to capture and retain sediment generated within the site. This includes practices such as sediment retention ponds, decanting earth bunds, silt fences and outlet protection.

Subject to the scale of these devices, interim controls such as silt fences or super silt fences may be appropriate to control runoff from these construction activities. As-built plans must be prepared for these devices to confirm compliance with the guideline requirements.

Step 4: Protect topsoil and manage stockpiles

If topsoil is to be removed and stored on site during works, it must be stabilised, especially if it is not located within the perimeter controls. Stockpiles should be located away from water bodies and the driplines of protected trees.

Step 5: Progressively deploy internal ESCs

As works progress, the erosive potential of a site should be minimised through the fundamental principles identified in Section A2.0. Sediment control measures need to be monitored and potentially adjusted or relocated as works progress throughout the site. Where this occurs, the altered or new device must be appropriately sized and as-built. (Note: For consented activities, such changes may require sign-off from Auckland Council.)

Step 6: Progressively stabilise the site as works progress

Minimise the area of disturbance throughout the project. Any areas that remain unworked for long periods of time, or any works that have been completed, should be stabilised as soon as possible.

Step 7: Set up and follow a management and monitoring system

Keep copies of the ESC Plan on site and update with variations as they occur. Specific resource consent requirements should be complied with throughout the project's lifetime. Unless otherwise specified in a resource consent, weekly monitoring of all control measures should be carried out to ensure everything is operating correctly. Monitoring should also be undertaken immediately before and after any significant rainfall.

Accumulated sediment should be cleaned out from most devices when they are 20% full (see Part 2 for details of each practice). Accumulated sediment should be disposed of on site in a location that cannot result in discharge from the site. If soil is contaminated, it should be managed appropriately and in accordance with the National Environmental Standard for *Assessing and Managing Contaminants in Soil to Protect Human Health* (New Zealand Government, 2011) (NES:CS).

C1.6 Decommissioning of controls

Once the site is permanently stabilised, the ESCs can be removed. Prior to removal, any sediment within these controls should be disposed of appropriately and care taken to ensure it does not discharge into any waterway or stormwater network. Any disturbed areas left by the controls should be stabilised immediately.

(Note: For sites that require resource consent, removal of ESCs may require approval by Auckland Council.)

C1.7 Compliance

The ESC Plan and selected management practices will need to be implemented in compliance with the permitted activity criteria or resource consent conditions.

The following steps are also recommended to ensure compliance and effective implementation:

- A start-up meeting be held with the ESC plan preparer, contractor and regulator (only for consented sites)
- Allocation of project roles and responsibilities for ESC
- Implementation of a communications plan for internal and external communications on ESC. Items in the plan may include a toolbox meeting agenda item on ESC; complaints procedures; details of who needs to be communicated with, about what, when and how; and key contact phone numbers
- Identification of higher risk areas, e.g. sites of known archaeological significance, contamination or other sensitivity such as waahi tapu
- Implementation of accidental discovery protocols, if required
- Weekly and post-event monitoring of devices
- Record keeping of compliance sheets.

C1.8 Other considerations

C1.8.1 Sustainability

Ensuring that there is a focus on sustainability is of utmost importance when planning and executing any land disturbance project.

Land disturbance activities link industry, communities and the environment. By adopting sustainable principles from the outset, many benefits can be achieved, including reduced costs, community buy-in, environmental compliance and restoration.

Consideration should be given to the themes and opportunities detailed in Table 3.

Table 3: Sustainability considerations for ESC

Theme	Opportunities
Governance	<ul style="list-style-type: none"> Establish sustainability goals Set sustainability priorities
Supply chain	<ul style="list-style-type: none"> Prioritise locally sourced materials Factor environmental and social costs into procurement processes Ensure products are produced by companies whose values incorporate sustainability
Materials	<ul style="list-style-type: none"> Consider the lifespan, recyclability and reusability of materials Design for deconstruction and disassembly Where appropriate, utilise the landscape and existing materials on site
Waste	<ul style="list-style-type: none"> Design-out waste from project conception Implement waste management plans Adopt the waste hierarchy into resource management practices (reduce, reuse, recycle) Pursue zero waste
Plants/biodiversity	<ul style="list-style-type: none"> Avoid vegetation removal where practical Eco-source plants Use culturally and socially acceptable plants for the site/area (particularly for permanent landscaping)
Discharges	<ul style="list-style-type: none"> Implement best management practices to avoid discharges to air, land and water
Energy	<ul style="list-style-type: none"> Prioritise use of renewable energy Adopt energy efficient practices
Water	<ul style="list-style-type: none"> Measure water consumption and aim to minimise water use on site
Earthworks strategy	<ul style="list-style-type: none"> Take a minimal earthworks approach/low impact design Stage construction

Theme	Opportunities
Community	<ul style="list-style-type: none"> • Foster stakeholder participation • Support local industry • Take into account Crime Prevention Through Environmental Design (CPTED) principles • Adopt best practice health and safety, including safety and design.

C1.8.2 Safety

The *Health and Safety at Work Act 2015* (New Zealand Government, 2018) (replacing the *Health and Safety in Employment Act 1992* and the *Machinery Act 1950*) requires a duty of care by those involved in ESC works to ensure that workers and other persons are not exposed to health and safety risks arising from the work site.

Safety in design (SiD) is an important consideration prior to the establishment of works. Designers must be able to demonstrate that ESC solutions include mitigating the exposure of workers and other persons to harm. Hazards and risks associated with the full lifecycle of the ESC solution should be identified and adequate controls included to eliminate or minimise them. Designers must also have appropriate training in, and understanding of, the purpose and technical standards of ESC, as well as SiD principles.

Suppliers of ESC devices or material components also have a duty of care to ensure the goods supplied do not expose workers or others to health and safety risks.

In accordance with *Health and Safety at Work Act 2015*, the contractor has a duty to ensure the safety of all persons on and in the vicinity of the site. This includes the provision of a safe working environment, safe plant, safe systems and appropriate training, supervision and monitoring. Earthworks' sites often require the contractor to establish and maintain a site-specific safety management plan. In addition to covering the general hazards on site, such as plant movement and buried utility services, the plan should consider all health and safety aspects that are unique to ESC. These should be communicated to all parties prior to work commencing.

Part 2 of this guideline identifies specific ways in which safety should be incorporated into different ESC practices on a construction site.



Figure 10: A typical earthworks construction site

C1.8.3 Cost benefits of ESC

Benefits and cost savings of implementing good ESC management for the project's lifecycle include:

- Enhanced credibility and reputation of both contractor and principal
- Fewer public complaints with reduced potential for fines and/or litigation
- Reduced compliance costs
- Reduced water treatment costs
- Protected site assets and reduced management costs
- Reduced construction delays
- Improved and protected recreational and aesthetic values
- Avoidance of the cost of rectifying offsite effects, including time and physical works
- Avoidance of Auckland Council enforcement and associated costs in lost time, legal advice and fines.

C1.8.4 Ancillary construction effects

While this guideline only considers the erosion and sedimentation effects of construction, there are other effects that should be addressed when undertaking construction activities. These may include:

- Noise and vibration
- Dust
- Ecological
- Heritage/cultural
- Geotechnical
- Contaminated land
- Existing infrastructure
- Social/economic.

Contaminated land can have a significant impact on how earthworks are carried out. When undertaking a site assessment, it is important to consider the history of the site to determine if there is any risk of soil contamination. Contaminated soil not only affects the environment, but also poses a risk to human health. Project planners/designers should therefore consult the National Environmental Standard for *Assessing and Managing Contaminants in Soil to Protect Human Health* (New Zealand Government, 2011) and the relevant regional plans when assessing regulatory requirements.



D Overview of ESC practices

Table of Contents

D1.0	Overview of ESC practices	33
D1.1	Scope of Part 2.....	33
D1.2	Current best practice methods and measures	34
D1.3	New emerging practices/innovations	34

Tables

Table 4: Best practice methods and measures covered by this document.....	34
---	----

D1.0 Overview of ESC practices

D1.1 Scope of Part 2

This part of the guideline outlines the ESC practices for earthwork activities that reflect the evolution of industry best practice and technological innovation. This part is split into four sections:

- **Section D - Overview of ESC practices:** Summarises the scope of Part 2 of the guideline, the practices included and the approach to new emerging practices/innovations
- **Section E - Erosion control practices:** Outlines best practice non-structural approaches to erosion control, as well as water management controls and soil stabilisation practices
- **Section F - Sediment control practices:** Outlines sediment control practices that are considered current best practice
- **Section G - Specific activities:** Explains what practices are most relevant for specific earthworks activities, including dewatering, small sites, roads and utilities, works within a watercourse, works within the CMA, quarrying and agriculture (farm tracking and general earthworks only).

For each practice detailed in Sections E and F:

- Guidance is provided in relation to design; construction, operation and maintenance; and decommissioning (where relevant)
- The guideline is structured in such a way that the construction, operation, maintenance, and decommissioning subsections for each practice can be printed separately from the design subsections. This will enable contractors (or other users) to only print out the sections they need to take on site.

Additional guidance for contractors on practices is provided in the Construction Quality Checklists Section in Appendix C. The purpose of these checklists is for contractors to complete on-site self-checks of construction quality for ESC practices. They are not intended as compliance or as-built checklists.

Recommended line types/symbols, e.g. ESC site plans/drawings are detailed in Appendix D. Example ESC site plans/drawings are provided in Appendix E. These are intended to provide guidance on what an ESC Plan should cover in terms of detail and content. Plans should always be tailored to the specific project and site.

D1.2 Current best practice methods and measures

The current best practice methods and measures covered in this part of the guideline include:

Table 4: Best practice methods and measures covered by this document

Erosion control practices E	Non-structural approaches	E1.0		Section
	Water management controls	E2.0	Clean water' diversion channels and bunds	E2.1
			Dirty water' diversion channels and bunds	E2.2
			Contour drains (cut-offs)	E2.3
			Check dams	E2.4
			Pipe drop structures and flumes	E2.5
			Stabilised entranceways	E2.6
			Surface roughening	E2.7
	Soil and surface stabilisation practices	E3.0	Top soiling and grass seeding	E3.1
			Hydroseeding	E3.2
Turfing			E3.3	
Mulching			E3.4	
Geotextiles and erosion control blankets			E3.5	
Sediment control practices F	Structural approaches	F1.0	Sediment retention ponds	F1.1
			Decanting earth bunds (including T bars)	F1.2
			Silt fences	F1.3
			Super silt fences	F1.4
			Silt socks	F1.5
			Stormwater inlet protection	F1.5
	Coagulant and flocculant treatment	F2.0		

Section G - Specific activities refers back to some of the above practices where relevant.

D1.3 New emerging practices/innovations

This guideline includes a comprehensive selection of current best practice ESC measures that have proven their effectiveness in the field. Note that ongoing development and innovation of ESC measures is dynamic and evolving. As such, Auckland Council will consider the use of new emerging ESC practices/innovations not explicitly included in this guideline if the practice/innovation and performance can be demonstrated to be an appropriate alternative in line with the principles of this guideline.



E Erosion control practices

Table of Contents

E1.0	Non-structural approaches	35
E1.1	Minimise disturbance	35
E1.2	Stage construction	35
E1.3	Protect slopes	36
E1.4	Protect watercourses	36
E1.5	Rapidly stabilise exposed areas	37
E1.6	Consider the timing of earthworks	37
E2.0	Water management controls - for concentrated water flows	38
E2.1	'Clean water' diversion channels and bunds	38
	E2.1.1 Design.....	38
	E2.1.2 Construction, operation and maintenance.....	42
	E2.1.3 Decommissioning	43
E2.2	'Dirty water' diversion channels and bunds	43
	E2.2.1 Design.....	43
	E2.2.2 Construction, operation and maintenance.....	45
	E2.2.3 Decommissioning	46
E2.3	Contour drains (cut-offs)	47
	E2.3.1 Design.....	47
	E2.3.2 Construction, operation and maintenance.....	49
	E2.3.3 Decommissioning	50
E2.4	Check dams	50
	E2.4.1 Design.....	50
	E2.4.2 Construction, operation and maintenance.....	53
	E2.4.3 Decommissioning	54
E2.5	Pipe-drop structures and flumes	55
	E2.5.1 Design.....	55
	E2.5.2 Construction, operation and maintenance.....	58
	E2.5.3 Decommissioning	60
E2.6	Stabilised entranceways	60
	E2.6.1 Design.....	60
	E2.6.2 Construction, operation and maintenance.....	64
	E2.6.3 Decommissioning	65
E2.7	Surface roughening	65

E2.7.1	Design.....	65
E2.7.2	Construction, operation and maintenance.....	67
E2.7.3	Decommissioning	67
E3.0	Soil and surface stabilisation practices	68
E3.1	Topsoiling and grass seeding	69
E3.1.1	Design.....	69
E3.1.2	Construction, operation and maintenance.....	72
E3.2	Hydroseeding	73
E3.2.1	Design.....	73
E3.2.2	Construction, operation and maintenance.....	75
E3.3	Turfing.....	76
E3.3.1	Design.....	76
E3.3.2	Construction, operation and maintenance.....	77
E3.4	Mulching	78
E3.4.1	Design.....	78
E3.4.2	Construction, operation and maintenance.....	81
E3.5	Geotextiles and erosion control blankets	81
E3.5.1	Design.....	81
E3.5.2	Construction, operation and maintenance.....	88

Figures

Figure 11:	Northern Motorway construction site - minimising disturbance.....	35
Figure 12:	Flume installed to protect steep slope.....	36
Figure 13:	Sediment discharge as a result of not protecting the watercourse	36
Figure 14:	Rapid stabilisation	37
Figure 15:	Clean water diversion used to isolate upper clean water flows from the works area	38
Figure 16:	Turfing scraped from within the site to stabilise the perimeter bund. The perimeter bund provides both clean and dirty water control	40
Figure 17:	Cross-section of clean water diversion bund	41
Figure 18:	Hotmix bund diverting the motorway runoff to the catchpit	41
Figure 19:	Cross-section of a dirty water diversion	44
Figure 20:	Dirty water diversion bund directing site water to a sediment retention pond.....	45
Figure 21:	Drop out pit.....	45
Figure 22:	Contour drain.....	47
Figure 23:	Contour drain installed across access track.....	47

Figure 24: Contour drain cross-section	49
Figure 25: Check dam	50
Figure 26: Check dams installed in series to act as a permanent water velocity control measure.....	50
Figure 27: Silt socks can be used as a check structure on a low gradient channel.....	51
Figure 28: Check dams installed with a spillway to direct flows over the centre of the structure. Sand bags placed directly below spillway provide a protective apron below the dam.....	52
Figure 29: Rock check dam.....	53
Figure 30: Flume conveying clean water over the works area.....	55
Figure 31: Geotextile lined flume.....	55
Figure 32: Wooden flume lined with impervious material.....	56
Figure 33: Pipe-drop structure and flumes	57
Figure 34: Pipe-drop structures conveying upper water down an exposed slope	58
Figure 35: Stabilised entranceway	60
Figure 36: Stabilised entranceway	62
Figure 37: Example of truck wash and shaker ramp	63
Figure 38: Example of a shaker ramp	63
Figure 39: Surface roughening with bulldozer.....	65
Figure 40: Surface roughening of a slope. Note the hollows acting as "micro" sediment traps.....	66
Figure 41: Surface roughening	67
Figure 42: Stabilisation via a combination of chip mulch, geotextile and aggregate.....	68
Figure 43: Grass stabilised earthworks site. Batter and building platforms	69
Figure 44: Initial grass strike - not stabilised	70
Figure 45: Approximately 40- 60% grass strike - not stabilised	70
Figure 46: Approximately 90 – 100% grass strike - stabilised.....	70
Figure 47: Loss of topsoil and grass seed after heavy rain event. Will require stabilisation and reapplication	72
Figure 48: Specialist application of hydroseed.....	73
Figure 49: Sports field being hydroseeded. Sediment control remains installed until an 80% grass strike has established	74
Figure 50: Recently applied hydroseed on a stormwater wetland	74
Figure 51: Same wetland one week later, grass starting to take well	75
Figure 52: Turf being placed adjacent to a stabilised swale.....	76
Figure 53: Turf used to provide instant stabilisation of the swale allowing for early commissioning of the device	77
Figure 54: Specialist application of hay mulch	78
Figure 55: Hydromulch application	79

Figure 56: Hydrohay as applied.....	79
Figure 57: Woodchip to stabilise the finished batter slope	80
Figure 58: Geotextile used to temporarily stabilise the batter face	81
Figure 59: Geotextile design – outfalls	84
Figure 60: Geotextile design – on slopes	84
Figure 61: Jute mesh	85
Figure 62: Straw blanket.....	85
Figure 63: Coconut fibre blanket used to stabilise batters while allowing grass to grow through	86
Figure 64: Bonded synthetic fibre mat used as erosion protection and medium for revegetation	87

Tables

Table 5: Contour drain spacing	49
Table 6: Positioning of check dams	52
Table 7: Sizing criteria for pipe-drop structures.....	57
Table 8: Sizing criteria for flumes	58
Table 9: Stabilised entranceway specifications	62
Table 10: Typical seed and fertiliser application rates	72
Table 11: Erosion control blankets/mats - design criteria.....	85
Table 12: Staple density	89

Preface

This section focuses on erosion control and describes the non-structural (Section E1.0) and structural (Sections E2.0 and E3.0) measures in accordance with the principles of erosion control outlined in Section A2.0 of this guideline. Within this section, the control of erosion from earthworks has been considered from two aspects:

- 1) Controlling the volume and rate of water runoff from within and external to a site (water management controls)
- 2) Providing a protective cover against soil erosion using stabilisation methods (soil stabilisation practices).

On any earthworks site, both of these techniques will be required. However, the choice of which erosion control measure is used will depend on site-specific constraints and the project construction staging.

It is rare for only one practice to be used. It is more likely that more than one practice is needed to achieve an appropriate level of erosion control.



Good example of staged construction and progressive stabilisation

E1.0 Non-structural approaches

Non-structural approaches to erosion control are closely linked to the fundamental principles of ESC detailed in Section A2.0 of this guideline (Part 1). The key principles (best practice management) of key relevance to erosion control are reproduced here for ease of reference. These principles and concepts provide guidance for ESC throughout the planning, construction and maintenance phases of a project.

E1.1 Minimise disturbance

The identification and retention of existing site attributes should be incorporated into project designs and earthworks should be minimised to the greatest extent practicable.

Land development needs to fit land sensitivity and where possible, avoid disturbance to steeper slopes and other features such as streams and wetlands.



Figure 11: Northern Motorway construction site - minimising disturbance

Earthworks should be the minimum necessary to achieve the design outcome (including temporary works). The area of earthworks exposed to erosion at any given time should also be minimised by staging and progressive stabilisation (refer Figure 11).

All limits of disturbance should be shown on the ESC Plan. On-site limits of disturbance should be clearly shown using fences, signs and flags.

E1.2 Stage construction

By exposing only those areas that are needed for active earthworking at any one time, the duration of exposure and risk of erosion/sediment discharge will be minimised. Erosion is limited by applying earthworks staging, where the site has earthworks undertaken in smaller units over time with progressive revegetation.

Earthworks staging needs to be planned in conjunction with the overall construction sequencing to ensure that it accommodates the contractor's requirements. Temporary stockpiles, access and utility service installation all need to be planned.

Both earthworks staging, and sequencing should be detailed in the ESC Plan.

E1.3 Protect slopes

If worked slopes require stabilisation, simple vegetative covers such as topsoiling and seeding may be less effective and additional measures may be required.

Disturbing existing slopes should be avoided wherever possible, particularly those that are steep. To minimise erosion, clean water runoff from above the site must be diverted away from the exposed slopes (refer Figure 12).

Slopes should be highlighted on the ESC Plan, as well as limits of disturbance and any works and areas requiring specific protection.



Figure 12: Flume installed to protect steep slope

E1.4 Protect watercourses

Protection of watercourses is essential to avoid sediment discharges similar to that shown in Figure 13.

Earthworks and the removal of vegetation beside or within streams (including intermittent streams), wetlands and the coast, typically require consents from Auckland Council. Auckland Council should be consulted on these matters prior to finalising project designs.

All existing watercourses, proposed drainage patterns, limits of disturbance and protection measures should be mapped on the ESC Plan. In addition, all practices to be used to protect new drainage channels should be marked, as well as crossings, disturbances and associated construction methods.



Figure 13: Sediment discharge as a result of not protecting the watercourse

Further advice on works within a watercourse is provided in Section G4.0.

E1.5 Rapidly stabilise exposed areas

Disturbed soils should be progressively stabilised with vegetation, mulch, grassing or other stabilising methods after each earthworks stage and at specific milestones within stages (refer Figure 14). Available stabilisation methods are site-specific and are described further in Section E3.0.

Time limits for grass or mulch covers should be clearly defined in the ESC Plan, along with a requirement for temporary cover in the case of severe erosion or poor germination.



Figure 14: Rapid stabilisation

E1.6 Consider the timing of earthworks

Weather affects erosion directly and indirectly. The direct relationship arises from rain which can instigate erosion when raindrops dislodge soil particles and runoff carries the particles away. Annual patterns of rainfall and temperatures, by and large, determine the extent and growth rate of vegetation.

The Auckland region receives about 1200 mm of rainfall annually, with average monthly rainfalls greatest throughout the winter period. As this impacts on the practical ability for earthworks to be undertaken, there is an earthworks season in Auckland from 1 October to 30 April. The dryer and warmer summer months are the best time to schedule bulk earthworks activities.

For specific high-risk activities such as stream works, it is critical to undertake works during a period of forecast fine conditions. Attention to a weekly and longer-range forecast can assist in scheduling works and preparing sites in advance of forecast rainfall events.

E2.0 Water management controls - for concentrated water flows

Control of water runoff or concentrated water flows is one of the most important erosion control measures that can be undertaken in a works area. Water runoff can either be 'clean' (i.e. devoid of sediment) or 'dirty' (i.e. carrying sediment). In an ESC context, 'clean water' usually refers to water from above a work site that has not run through the works area, and 'dirty water' usually refers to water that has run through a works area and requires treatment prior to discharge.

Water management control practices help to reduce water velocities and contributing catchment areas, with the overall aim of minimising sediment generation.

Guidance is provided below (Sections E2.1 to E2.7) on common measures to control water runoff on earthworks sites. Guidance for each control/measure is split into the following subsections:

- Design
- Construction, operation and maintenance
- Decommissioning.

E2.1 'Clean water' diversion channels and bunds

E2.1.1 Design

Definition

This practice comprises a non-erodible channel and/or bund constructed for a specific design storm to convey any clean water runoff.

Earthworks bunds are constructed by forming an embankment to hold back the water. Hotmix diversion bunds are constructed of Hotmix directly on the impervious surface and are often a replacement for a removed kerb and channel.



Figure 15: Clean water diversion used to isolate upper clean water flows from the works area

Purpose

These measures are used primarily to intercept and convey runoff to stable outlets, ideally at non-erosive velocities. Clean water diversions (Figure 15) intercept clean water away from the works area. Erosion damage potential is minimised by reducing the volume of water flowing over the site. This also then reduces the potential for sediment generation and the size of sediment-control device needed. Hotmix diversion bunds can be used to divert runoff from impervious surfaces, which are typically motorway, roads, car parks or building platforms.

Conditions where practice applies

Clean water runoff diversion channels and bunds are mainly used in the following situations:

- To divert clean runoff water from above the works site, and divert it to non-erodible outlet(s)
- As a physical 'perimeter boundary' of an earthworks site to isolate the site and prevent clean water entering the area.

Limitations

Clean water diversions have the following limitations:

- The longitudinal gradients need to be less than 2%; otherwise a channel lining will probably be required
- All up-slope (clean water) diversions need a stable outlet
- They need to be sized and constructed for the site conditions and should not be confused with contour drains (refer Section E.2.3)
- On some sites (e.g. with steep slopes and/or unstable ground), specific geotechnical design will be required to avoid failure of the diversion
- Subsoils that are erodible and/or prone to piping failures may be exposed along the invert of excavated diversions. If left unchecked, serious lower slope stability problems may result
- On steep slopes, it is often difficult to construct a channel bank or drain with the required channel capacity. The location of the clean water discharge point also needs to be considered
- Access for maintenance can be difficult once construction activities have commenced.

Key design criteria

Runoff diversions are essentially channels that are typically constructed across a slope. They require a bund on the down-slope side to prevent flow from spilling out of the channel. Runoff diversions may take the form of:

- Drains, which are usually lined with an erosion-resistant material such as needle-punched fabric
- Existing or new stormwater reticulation systems
- A combination bank or bund with excavated up-slope channel
- An earthen bank, which is often made from compacted and stabilised topsoil (such as the perimeter bund in Figure 16)
- Hotmix.

There are many designs for runoff diversions; however, the following key aspects are required:

In choosing the location:

- Consider the contributing catchment area, outlet conditions, topography, land use, soil type, length of slope, seep planes (if seepage is an issue) and the development layout
- Where practicable, choose a route for structures that avoids trees, existing or proposed service infrastructure, existing or proposed fence lines, and other natural or built features.



Figure 16: Turfing scraped from within the site to stabilise the perimeter bund. The perimeter bund provides both clean and dirty water control

For design of up-slope clean water diversions:

- Formally design diversions where catchments exceed 5 ha
- A standard clean water diversion arrangement may be used on sites below this threshold as shown in Figure 17
- Diversions must have sufficient capacity to carry the flow safely from a 5% annual exceedance probability (AEP) storm, plus a freeboard of 300 mm
- If the site is located within the 1% AEP floodplain, consider how any flood waters may be managed, and any upstream and downstream impacts that may result
- Include all calculations, design notes, drawings, etc. in the site ESC Plan
- All clean water diversions need to be stabilised with no exposed surfaces
- Where design velocities exceed 1 m/sec, a channel liner is required to prevent scour
- Line exposed temporary diversions with a needle-punched geotextile fabric
- Outlets from all up-slope diversions must discharge water so that the erosion hazard to down-slope lands and waterways is no greater than that in the pre-development condition, up to the design storm event
- Include appropriate energy dissipation structures at the outlet of all diversions.

In designing the cross-section:

- A diversion bund (with no constructed channel) can be used in areas of easy grade. Ensure the internal sides of the bund associated with the diversions are no steeper than 3:1, and the external sides no steeper than 2:1, as outlined in Figure 17 below
- A diversion drain with a constructed parabolic or trapezoidal channel and geotextile stabilisation should be used in areas of steep grade.

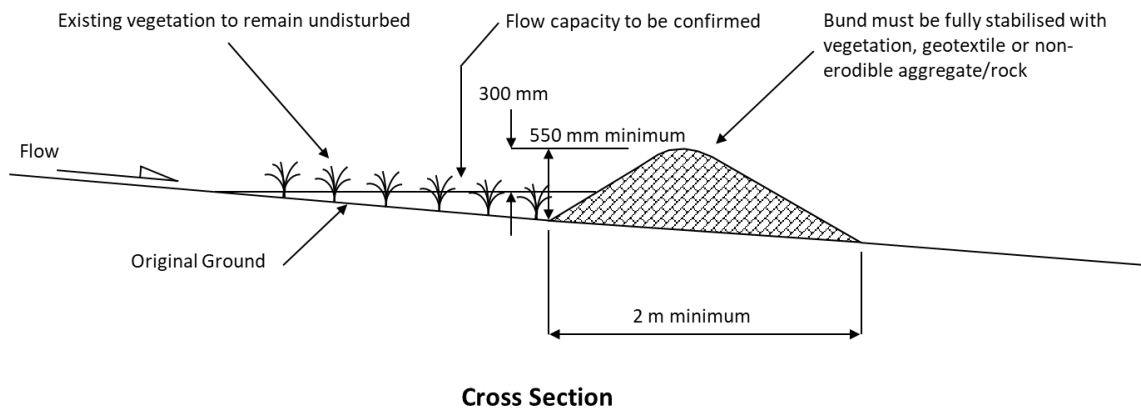

Figure 17: Cross-section of clean water diversion bund

Hotmix bunds (refer Figure 18) are normally used to divert motorway and road runoff from immediately adjacent work areas, they are typically low, between 150-300 mm high and generally shaped to allow crossing by vehicles and avoid flooding of the motorway or road. They will direct runoff to a stabilised outlet, typically an existing or new stormwater inlet, catchpit manhole or similar. In the absence of these inlets, the bunds often discharge into small (150 mm) flexible pipes which convey the flows through the work area to suitable inlet devices. The capacity of these outlets is limited and may require frequent spacing. Hotmix bunds are not appropriate for large catchments.



Figure 18: Hotmix bund diverting the motorway runoff to the catchpit

E2.1.2 Construction, operation and maintenance

Construction and operation

For construction and operation of diversion channels and bunds:

- Plan and construct all perimeter diversion works as part of the initial site establishment / development activities
- Prioritise these works and install the most important up-slope control first
- Define the route and survey it to achieve the correct gradient
- Construct drains with a uniform grade along the invert, as sudden decreases may cause sediment to accumulate causing the bank to be overtopped
- Ensure bunds associated with diversions are well compacted, and stabilised. Assess the risk of failure. If the consequences are high, specific geotechnical design may be required to ensure the stability and integrity of the structure
- Stabilise all diversion areas. One method is to carefully set aside and replace existing grass and topsoil sods in the invert of the newly constructed drain, or over the newly constructed bund (refer to Figure 16)
- Monitor diversions for erosion. Subject to the soils on site, it is likely that erosion control will be needed where the gradients are greater than 2% or where the design velocities exceed 1 m/sec
- Ensure the finished cross-section meets all design requirements
- Provide an adequate outlet for each diversion. It may be a stable channel (e.g. rip-rap, geotextile), vegetated or paved area, stable watercourse or pipe outlet. In all cases, the outlet must convey runoff to a point where outflow will not cause damage (erosion, flooding). Vegetated outlets should be installed before diversion construction, to ensure establishment of vegetative cover in the outlet channel.

Maintenance

Perimeter diversions require regular maintenance to ensure they keep functioning throughout their life.

Maintenance requirements should include:

- Unless otherwise specified, inspect weekly and after every rainfall and during periods of prolonged rainfall for scour and areas where diversions may breach. Repair immediately, if required, to ensure that the design capacity is maintained
- Remove any accumulated sediment deposited in the diversion channel where there is a risk of overtopping due to a lack of freeboard
- Check invert and outlets to ensure that these remain free from scour and erosion. These points may require geotextile lining to avoid this effect
- Look for low spots, areas of water ponding, formation of tunnel gullies, sediment deposition and debris blockage
- Check for stabilisation cover and ensure full stabilisation cover remains where required
- Take particular care to protect against damage from earthmoving operations and reinstate the diversion if damaged.

E2.1.3 Decommissioning

For decommissioning of diversion channels or bunds:

- Remove diversions only when all disturbed areas below the clean water diversion have been stabilised
- Fill, compact and shape all disturbed areas to blend in with the finished landform
- Stabilise all areas disturbed as part of the removal process; apply seed and fertiliser, protect with mulch or erosion-control blankets, if required.

E2.2 'Dirty water' diversion channels and bunds

E2.2.1 Design

Definition

This practice comprises a non-erodible channel and/or bund for the conveyance of dirty water that is constructed for a specific design storm.

Purpose

Dirty water diversions convey sediment-laden water within the disturbed area and direct it to a sediment-retention device to enable it to be treated.

Conditions where practice applies

Dirty water diversions and bunds are used to divert sediment-laden water to an appropriate sediment-retention device (e.g. sediment retention pond or decanting earth bund - refer Section F). They are typically located within or at the lowest extent of the disturbed area.

Limitations

Dirty water diversions have the following limitations:

- Where longitudinal gradients are greater than 2%, stabilisation may be required to prevent significant erosion
- They need to be sized and constructed for the site conditions and should not be confused with contour drains (refer Section E.2.3)
- In some examples (e.g. steep slopes and/or unstable ground), specific geotechnical design will be required to avoid failure of the diversion
- Subsoils that are erodible and/or prone to piping failures may be exposed along the invert of excavated diversions. If left unchecked, serious lower slope stability problems may result
- On steep slopes, it is often difficult to construct a channel bank or drain with the required channel capacity. The location of the sediment retention device (which the dirty water diversion will flow into) also needs to be considered
- Access for maintenance can be difficult once construction activities have commenced.

Key design criteria

Dirty water diversions are channels that are typically constructed across a slope (refer Figure 19 and Figure 20). This requires a bund on the down-slope side to prevent flow from spilling out of the channel. Runoff diversions may take the form of:

- Drains, which can be lined with an erosion-resistant material such as needle-punched fabric
- A combination bank or bund with excavated up-slope channel
- An earthen bank, which is often made from compacted soil.

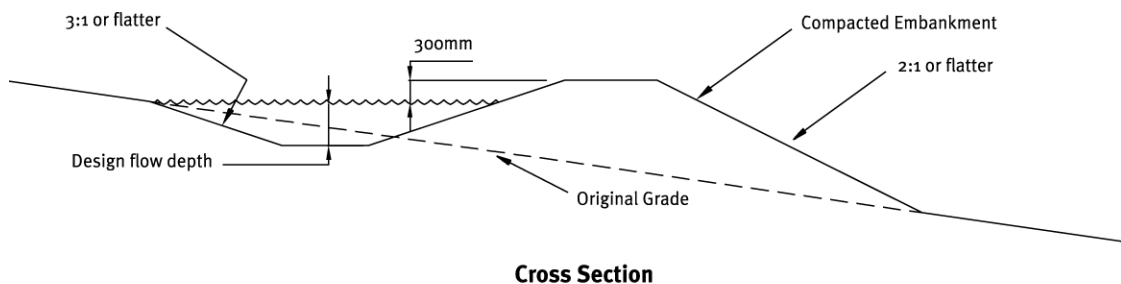

Figure 19: Cross-section of a dirty water diversion

There are many designs for runoff diversions; however, the following key aspects are required in choosing the location:

- Determine the location by considering the contributing catchment area, outlet conditions, topography, land use, soil type, length of slope, seep planes (if seepage is an issue) and the development layout
- Where practicable, choose a route for structures that avoids trees, existing or proposed service infrastructure, existing or proposed fence lines, and other natural or built features.

For design of down-slope dirty water diversions:

- Formally design diversions where catchments exceed 5 ha
- A standard dirty water diversion arrangement may be used on sites below this threshold, as shown in Figure 19 above
- Diversions must have sufficient capacity to safely carry the flow from a 5% AEP storm, plus a freeboard of 300 mm
- Include all calculations, design notes, drawings, etc. in the Site ESC Plan
- Diversion gradients greater than 2% may need to be lined to minimise erosion
- On steep sites, construct a 'drop-out pit' within the dirty water diversion (refer Figure 21) to allow heavier sediment particles to drop out before they enter the sediment retention device, reducing the load on the device. Drop-out pits are approximately 500 to 1,000 mm deep and 1,000 mm wide. They are easier to maintain and typically cheaper to desilt than desilting the sediment retention device (refer to Figure 21)

- Where design velocities exceed 1 m/sec, a channel liner may be required to prevent erosion



Figure 20: Dirty water diversion bund directing site water to a sediment retention pond



Figure 21: Drop out pit

- Where practicable, ensure a uniform grade along the invert of the diversion. Increases in grade can cause scour, while sudden decreases in grade may cause sediment to accumulate, causing the drain to overtop
- Outlets from all diversions must discharge to an appropriate sediment control device for treatment.

E2.2.2 Construction, operation and maintenance

Construction and operation

For construction and operation of dirty water diversion channels and bunds:

- Plan and construct all dirty water diversion works as part of the initial site establishment/development activities
- Define the route and survey it to achieve the correct gradient
- Construct drains with a uniform grade along the invert, as sudden decreases may cause sediment to accumulate causing the bank to overtop
- Ensure the bunds associated with the diversions are well compacted and stabilised. In some instances, this may require specific geotechnical design to ensure the stability and integrity of the structure
- Monitor diversions for erosion. Depending on the type of soils on site, it is likely that erosion control will be needed where the gradients are greater than 2% or where the design velocities exceed 1 m/sec
- Ensure the finished cross-section meets all design requirements
- Provide an adequate outlet for each diversion (i.e. dirty water to a sediment control device).

Maintenance

Dirty water diversions require regular maintenance to ensure they keep functioning throughout their life. Maintenance requirements should include:

- Inspect weekly and after every rainfall and during periods of prolonged rainfall for scour and areas where diversions may breach. Repair immediately, if required, to ensure that the design capacity is maintained
- Remove any accumulated sediment deposited in the diversion channel where there is a risk of overtopping due to a lack of freeboard
- Check invert and outlets to ensure that these remain free from scour and erosion. These points may require geotextile lining to avoid scour
- Look for low spots, areas of water ponding, formation of tunnel gullies, sediment deposition and debris blockage
- Check for stabilisation cover and where required, ensure full stabilisation cover remains
- Perimeter diversions need particular care to protect against damage from earthmoving operations and should be reinstated if damaged.

E2.2.3 Decommissioning

For decommissioning of diversion channels or bunds:

- Remove diversions only when all disturbed areas above the dirty water diversion have been stabilised
- Fill, compact and shape all disturbed areas to blend in with the finished landform
- Stabilise all areas that have been disturbed as part of the removal process; apply seed and fertiliser, protect with mulch or erosion-control blankets, if required.

E2.3 Contour drains (cut-offs)

E2.3.1 Design

Definition

Contour drains or cut-offs are temporary excavated channels or ridges, or a combination of both, that are constructed across the contour of a land area that has been disturbed by earthworks (see Figure 22 and Figure 23).

Purpose

Contour drains are temporary in nature. They are often installed at the end of the day or when rain is forecast and removed while earthworks are being undertaken.

Their purpose is to break overland flow that is draining down disturbed slopes, by reducing the slope length, thereby reducing the velocity and therefore, the erosive power of runoff. The drain also diverts sediment-laden water to appropriate controls via stable outlets.

Conditions where practice applies

- The practice of using contour drains should be promoted on all earthwork sites, especially where there are large areas of exposed ground and long, steep slopes. The specific scenarios for their application include:
 - To reduce the overall slope length of a contributing catchment by breaking up the work area into smaller, more manageable zones so that the water velocities on these slopes are reduced, limiting the erosion potential of the water. They should be used at mid to lower slopes on all exposed areas
 - To assist with the diversion of dirty water flows towards sediment retention devices (e.g. a sediment retention pond, or decanting earth bund). (Note: They do not perform the same function as a dirty water diversion [refer Section E2.1], as they are more of a temporary feature. Also, they are not sized for a specific rain event unlike dirty water diversions.)
 - To act as cut-offs on tracking activities to direct water into a stable watertable and/or outfall structure.



Figure 22: Contour drain



Figure 23: Contour drain installed across access track

Limitations

Contour drains have the following limitations:

- They concentrate sheet flows, thereby increasing erosion potential which is of most concern on steep slopes and in any vulnerable soils, such as uncompacted fills and weak soils. As such, contour drains must discharge to a suitable diversion channel
- They may not be an effective practice on very steep slopes (>30%) unless they are very closely spaced to achieve required performance characteristics
- Unless the right sizing and spacing of drains is used, they have potential to overtop during high intensity rainfall events
- Longitudinal contour drains with >2% grades will increase flow velocities and may promote erosion. Therefore, steeper contour drains need to be lined to prevent scouring within the channel invert
- Excessively flat contour drain grades mean sediment deposition is likely to occur, reducing capacity and potentially resulting in overtopping of the structure
- Due to their temporary nature, they may be a 'weak link' in the ESC Plan if they are installed too late or not sized/spaced appropriately.

Key design criteria

Formal design of contour drains is generally not required due to their temporary nature. Although commonly called contour drains, this term is misleading as the drains need to be constructed slightly off the contour to ensure they drain appropriately.

The following design principles are critical to their effectiveness as an erosion control practice (also refer to Figure 24):

- Minimum compacted bank height of 250 mm
- Minimum total depth of 500 mm
- Longitudinal gradients not to exceed 2% (otherwise lining may be required)
- Broad enough to create a low-profile bank so that large earthworking machinery can safely cross (If this is not achievable, a dedicated crossing using a removable culvert can be used.)
- Parabolic or square shape profile preferred to avoid potential erosion typically associated with "V" profiles
- Must discharge to a diversion channel
- Outlets may need to be lined with geotextile or other suitable material to prevent erosion
- No individual drain should have more than 0.5 ha draining into it.

Indicative maximum catchment slope lengths are provided in Table 5 below:

Table 5: Contour drain spacing

Slope of site (%)	Spacing (m) of contour drains
Less than 5%	50
5 - 10%	40
10 - 15%	30
15 - 30%	20

Specifications for contour drains are outlined in Figure 24 below.

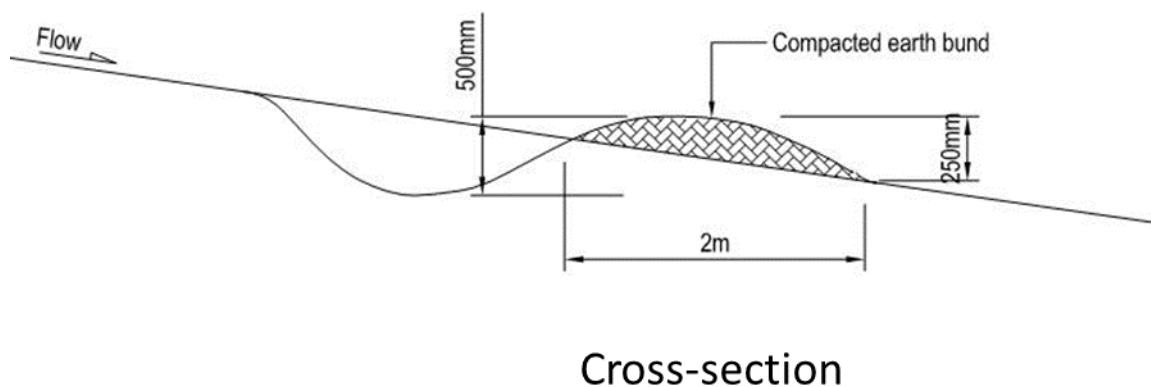

Figure 24: Contour drain cross-section

E2.3.2 Construction, operation and maintenance

Construction and operation

For construction of contour drains:

- Construct temporary contour drains across unprotected slopes within the working area at the end of each day's work, before site closedown or when rain is imminent
- Spacing and set-out are critical factors in constructing effective contour drains. Start from an erosion-proof outlet and work back
- Where possible, break up the work area using a series of more or less evenly spaced blocks using the slope length and spacing guide in Table 5
- Keep the invert gradient around 2% and make the drain as short as possible

- Avoid V-shaped drains created by a grader or bulldozer, as these can be a source of sediment. Tyre roll the completed drain to limit this
- Use an excavator or backhoe to construct a parabolic drain
- Compact all earth windrows and banks by tracking with construction plant.

Maintenance

The key items to check as part of the regular inspection of contour drains include:

- Repair or reinstate contour drains if damaged by machinery movement
- Inspect contour drains during rainfall or storms and repair as necessary
- Check the outfall for erosion and repair if required. It may be necessary to install a temporary flume or provide geotextile.

E2.3.3 Decommissioning

There is no formal decommissioning process for contour drains. Earthworks will simply recommence after the rainfall event.

E2.4 Check dams

E2.4.1 Design

Definition

Check dams are small dams made of rock rip-rap or other non-erodible material constructed across a swale or channel to act as grade-control structures (refer Figure 25).

Purpose

Their purpose is to reduce the velocity of concentrated flows.

They are often placed in series down the channel (refer Figure 26) and used during construction to reduce invert scour in drains or channels that will be reworked, filled, grassed or otherwise stabilised.

Check dams are not intended to be a sediment retention practice. The dams work by temporarily ponding the water and releasing it at a more controlled rate by overtopping the dam.



Figure 25: Check dam



Figure 26: Check dams installed in series to act as a permanent water velocity control measure

Conditions where practice applies

Check dams are placed within temporary swales or channels that, because of their short length of service, may not be suitable for a non-erodible lining (e.g. geotextile), but still need some protection to reduce erosion. They are used in either temporary or permanent swales/channels that need protection during the establishment of vegetative linings or other materials.

Limitations

Check dams have the following limitations:

- The contributing catchments for a complete series of check dams should not exceed 1 ha for slopes less than 10%
- Contributing catchments with a greater area or slope than this require specific engineering design
- They may not be an effective practice on steep channel grades, as they would need to be closely spaced to achieve the design criteria
- Check dams are water-control measures only; they are not intended to trap sediment
- Channels will erode if the dams are spaced too far apart (especially on highly erodible soils)
- Check dams can be time-consuming to construct, especially on steep slopes where a greater frequency of dams per unit length is required
- They may not be a suitable option to provide erosion protection when highly erodible soils are prevalent
- They should not be used within watercourses.

Key design criteria

The following design criteria apply to check dams:

- Temporary check dams are typically constructed of loose rock (rip-rap) or sandbags. Silt socks can also be used in low gradient channels (refer Figure 27). It is critical that they are constructed of competent material and do not themselves erode, or result in additional erosion
- Check dams can be either constructed with a 450 mm centre height or a 600 mm centre height. Table 6 is to be used to determine the spacing of check dams for channel slopes within the indicated ranges. Specifications are outlined in Figure 29.



Figure 27: Silt socks can be used as a check structure on a low gradient channel

Table 6: Positioning of check dams

Slope of site (%)	Spacing (m) between dams with a 450 mm centre height	Spacing (m) between dams with a 600 mm centre height
Less than 2%	24	30
2 - 4%	12	15
4 - 7%	8	11
7 - 10%	5	6
>10%	Unsuitable - use stabilised channel or specific engineered design	Unsuitable - use stabilised channel or specific engineered design

- The maximum height of a check dam depends on the depth of the drain into which it is being placed. As a general rule, the centre height (spillway level) should be no higher than 600 mm
- All check dams must incorporate a spillway to direct flows over the centre of the structure (refer Figure 28) with the spillway elevation at least 150 mm to 200 mm lower than the crest of the structure
- To be effective, place check dams so that the toe of the upstream dam is at the same elevation as the centre height (spillway level) of the downstream dam, with the spacing between dams outlined in Figure 29
- When used on highly erodible soils, check dams should be placed on a needle-punched geotextile fabric to minimise the chance of water undermining the structure.



Figure 28: Check dams installed with a spillway to direct flows over the centre of the structure. Sand bags placed directly below spillway provide a protective apron below the dam

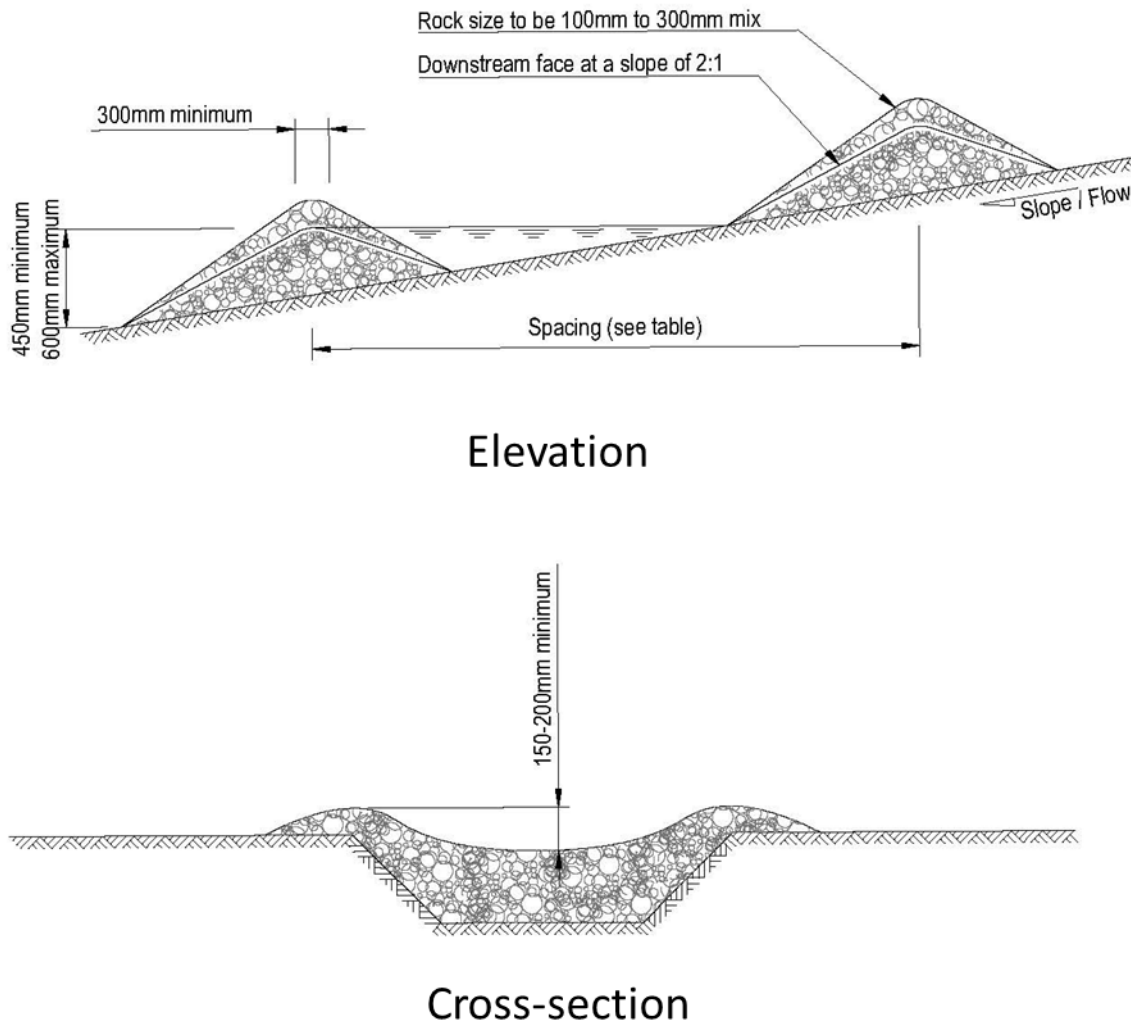

Figure 29: Rock check dam

E2.4.2 Construction, operation and maintenance

Construction and operation

For construction of check dams:

- Confirm the spacing/location of the dams in relation to the gradient of the drain or existing scour patterns
- Start from the bottom and work up the drain or channel
- Check that the invert of the drain or channel is stable above the top of the check dam
- Construct the centre of the check dam 150-200 mm lower than the outside edges to form a well-defined spillway
- Verify the dam location and spillway depth with an automatic level or other suitable equipment such as a 3 m straight edge and a spirit level

- Use loose rocks or extend sandbags approximately 300 mm to 400 mm away from the downstream toe of the dam to form a small protective apron below the spillway. This will armour the area below the dam when water runs over the spillway
- Place geotextile fabric beneath check dams constructed on erodible soils
- Make sure that the fabric used for sandbags is UV resistant
- Extend the toe of the fabric dams a least 1 m up-slope and then bury it in a 300 mm deep trench.

Maintenance

Key items to check as part of the regular inspection include:

- Repair or reinstate the check dams if destroyed by machinery movement
- Inspect the check dams after rainfall or storms and repair as necessary
- Check if water is outflanking the structures and look for scouring around the edges of the check dams. If there is scouring, increase the centre height (spillway height) and/or turn up the edges of the structures
- If scour is occurring between check dams, then additional structures may need to be provided
- Check dams should be inspected for sediment accumulation after each significant rain event. Sediment should be removed when it reaches 40% of the original height or before this occurs.

E2.4.3 Decommissioning

For decommissioning of check dams:

- Remove check dams when no longer needed, and where possible, salvage all materials for re-use in future check dams or other works
- Do not remove check dams that are protecting grass-lined channels until a complete and sustainable cover has been achieved
- Areas disturbed by the removal process must be seeded, fertilised and protected with surface mulch or erosion-control matting if required.

E2.5 Pipe-drop structures and flumes

E2.5.1 Design

Definition

A pipe-drop structure or flume is a temporary pipe structure or constructed flume placed from the top of a slope to the bottom of a slope (refer Figure 30 to Figure 33).

Purpose

Their purpose is to convey a concentrated flow of either clean or dirty surface runoff down a slope without causing erosion.

Conditions where practice applies

These measures should be used where concentrated flow of surface runoff is to be conveyed down a slope steeper than 3:1 (H:V). In general, two types of devices are used (pipe-drop structures or flumes), as follows:

- Pipe-drop structures or flumes may be either temporary or permanent structures
- Both pipe-drop structures and flumes are commonly used in association with diversion channels or bunds, which act to collect and direct surface runoff into the structure
- Pipe-drop structures or flumes may be used to divert flows down batters to the forebay of a sediment retention pond and also at the final point of discharge into the receiving environment
- Flumes may also be used to stabilise an actively eroding gully head.

Limitations

The following limitations apply to this measure:

- Severe erosion may result when the drains fail by overtopping, piping or pipe separation
- Pipe-drop structures are suitable up to a maximum catchment of 1 ha before specific engineering design is required. Flumes may be used with contributing catchments of up to 5 ha (subject to compliance with the design criteria within this guideline)
- Damage to the pipe-drop structure or flume may result from slippage or slumping caused by unstable foundation material
- Regular monitoring and maintenance is required to ensure that the structures are operating effectively.



Figure 30: Flume conveying clean water over the works area



Figure 31: Geotextile lined flume

Key design criteria

Temporary pipe-drop structures or flumes may be fabricated from needle-punched geotextile fabric, concrete, steel or plastic half-round pipes, rock, sandbags, lay-flat or construction ply. Any number of products can be used, provided they can convey water safely over exposed soils or unstable slopes.

The following general design criteria are relevant:

- Always use flumes/pipe-drop structures where slopes are steeper than 3:1 and where channelised surface runoff must be conveyed down the slopes
- The pipe-drop structure or flume should be impervious and must prevent water from flowing under the structure (see Figure 31 and Figure 32). For this reason, the use of a needle-punched geotextile in this application would require careful consideration and potentially, two layers
- The height of the runoff diversion channel or bund (when measured from the invert) that is used to divert flows to the pipe-drop structure or flume must be at least 2 x the pipe diameter or 2 x the height of the flume
- The inlet to the flume or pipe should include a 1 m long stabilised entry apron (e.g. by using geotextiles as outlined in Section E3.5) to minimise drawdown scour. This needs to be on at least a 3% grade
- The flume and pipe-drop structure should be extended beyond the toe of the slope being protected. The outfall should be appropriately protected with an energy dissipation device (e.g. geotextile, sand bags, rip-rap).



Figure 32: Wooden flume lined with impervious material

Design details are outlined in Figure 33.

Pipe-drop structures

For pipe-drop structures (refer Figure 33):

- Table 7 provides guidance on the maximum catchment area draining into a pipe-drop structure. For catchments larger than 1 ha, specific engineering design will be required
- The pipe-drop structure should have:
 - A gradient no shallower than 3:1
 - An inlet bank (made of compacted material) or wing walls at the inlet of the pipe that are a minimum of 2 x the height of the pipe-drop structure
 - Adequate provision for securing the pipe-drop structure to the slope. As a minimum, the pipe-drop structure is to be anchored every 4 m.

Table 7: Sizing criteria for pipe-drop structures

Pipe diameter (mm)	Maximum catchment area (ha)
150 mm	0.05 ha
300 mm	0.20 ha
450 mm	0.60 ha
600 mm	1.00 ha
Specific design required	>1.00 ha

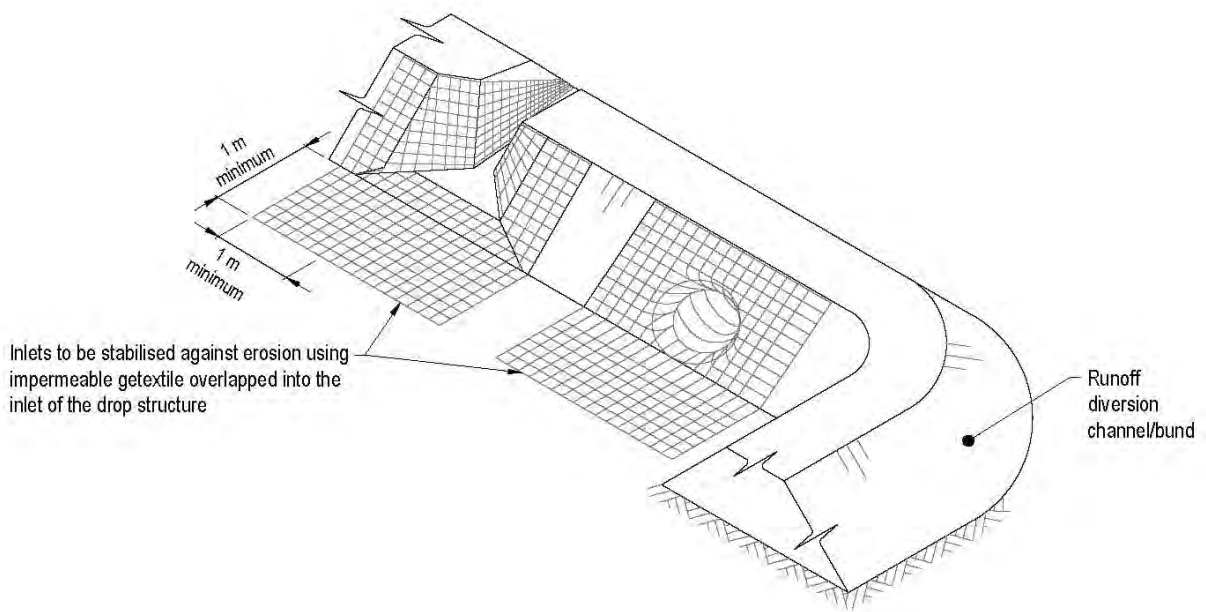
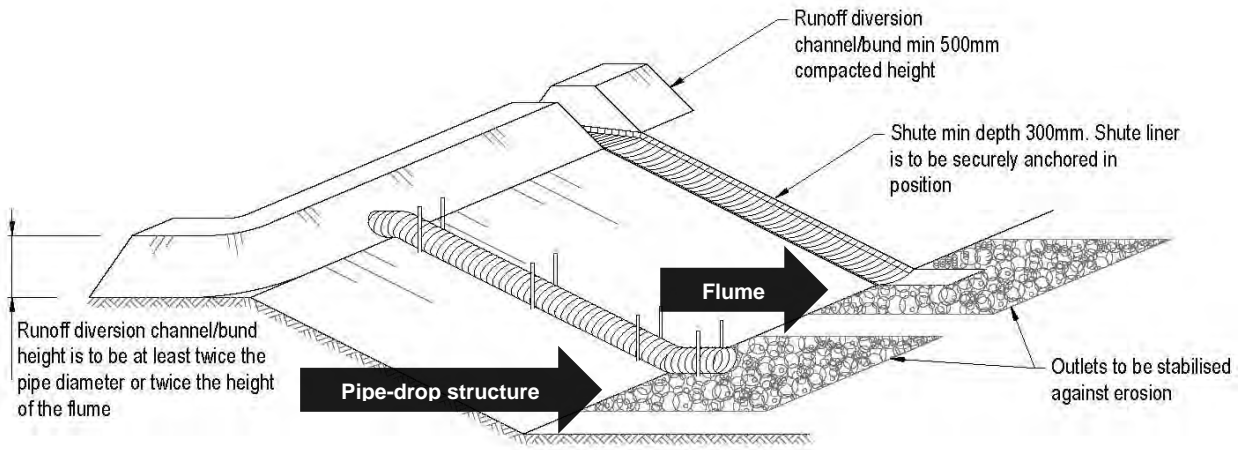

Figure 33: Pipe-drop structure and flumes

Flumes

For flume structures:

- Temporary flumes should be limited to the catchment areas outlined in Table 8
- When contributing catchments exceed these thresholds, specific engineering design will be required
- The temporary flumes must provide:
 - An effective flume width of 1.5 m per ha of contributing catchment area. (Note: 'Effective width' approximates to the surface width of shallow flow in the flume, which will be marginally greater than the flume base width)
 - Gradient no shallower than 3:1
 - Minimum of 2 x height of the flume of compacted material of inlet bank or wing walls at the top of the flume
 - Minimum of 300 mm deep cut-off trench at top of flume to avoid undercutting the fabric
 - Minimum of 300 mm flume sidewall height (or flume depth)
- Geotextiles have maximum flow rate limitations; consult the manufacturer for proper selection.

Table 8: Sizing criteria for flumes

Catchment slope (%)	Maximum catchment area (ha)
>18%	2.5 ha
<18%	5.0 ha

E2.5.2 Construction, operation and maintenance

Pipe-drop structure construction and operation

A common cause of failure of pipe-drop structures is water saturating the soil and seeping along the pipe where it connects to the runoff diversion channel. To eliminate this type of failure, backfill and compact properly around and under the pipe with stable material to achieve firm contact between the pipe and the soil at all points (refer Figure 34). In addition:

- Use rigid pipe material or flexible pipe material
- Pin/secure the structure to the slope in the required position at least every 4 m. Use no less than two anchors equally spaced along the length of the pipe
- Ensure that all pipe connections are watertight.



Figure 34: Pipe-drop structures conveying upper water down an exposed slope

Flume construction and operation

A common cause of failure of flumes is outflanking of the entrance or scouring of the invert of the flume. This can be prevented by waterproofing the flume entrance by trenching in an appropriate impervious geotextile or plastic liner, so that all flows are channelled directly into the flume. In addition:

- Orientate flumes directly down-slope
- Wherever practicable, construct the flume on well-compacted soils or undisturbed soils
- Ensure bund or wing walls are high enough and shaped so as to direct water into the centre of the flume
- Use compacted earth, sandbags or other measures, as necessary, to ensure water does not flow past the entry
- Provide a stabilised apron 1 m in width at the top of the flume (e.g. geotextile fabric), to minimise drawdown scour as water accelerates down the flume
- Ensure that the flume is deep enough to contain water
- Work to a minimum 300 mm depth
- Ensure that timber or other rigid construction flumes are adequately supported to ensure that neither movement, nor settlement, result in separation of joints
- Securely fasten two layers of fabric to the soil. Follow the manufacturer's specifications, or pin the fabric at 0.5 m intervals
- Provide a velocity dissipation structure at the bottom of the flume, such as sand bags or loose rock. Do not discharge water directly onto bare, unstable or erodible soils.

Maintenance

For maintenance of pipe-drop structures and flumes:

- Inspect the pipe-drop structure or flume weekly and after each rain event and immediately carry out any maintenance required
- Keep the inlet open at all times
- Check for evidence of water bypassing, undermining or overtopping the pipe-drop structure or flume
- Check for scour at the base of the pipe-drop structure or flume, or in the receiving downstream area. If eroded, repair damage and install additional energy dissipation measures
- If downstream scour is occurring, it may be necessary to reduce flows being discharged into the device unless other preventative measures are implemented
- Extend the length of the pipe-drop structure or flume as earthworks progress and repair and/or modify the pipe-drop structure or flume as required
- Keep pipe-drop structures or flumes in place until runoff has been controlled and all disturbed areas have been stabilised, or until permanent stormwater systems have been commissioned
- Make sure that the pipe-drop structures or flumes do not result in ponding onto inappropriate areas (e.g. active traffic lanes, material storage areas, etc.).

E2.5.3 Decommissioning

For decommissioning of pipe-drop structures and flumes:

- Keep pipe-drop structures or flumes in place until runoff has been controlled and all disturbed areas have been stabilised, or until permanent stormwater systems have been installed and commissioned
- Remove temporary pipe-drop structures or flume materials and where possible, re-use and recycle
- Stabilise all areas disturbed as part of the removal process. Apply seed and fertiliser and/or protect the surface with mulch or erosion control blankets, if required.

E2.6 Stabilised entranceways

E2.6.1 Design

Definition

Stabilised entranceways are stabilised areas located at any entry or exit point of a construction site (refer Figure 35 to Figure 38).

Purpose

The purpose of a stabilised entranceway is to:

- Prevent site access points becoming sources of sediment
- Assist in minimising dust generation and disturbance of areas adjacent to the road frontage by providing a defined entry and exit point.

In some circumstances, a formal wheel wash or a vibrating cattle-grate system (shaker ramps) may be required to stop sediment being tracked off the site. A stabilised entranceway is not designed to remove mud or dirt from vehicle wheels when exiting the site and these measures may need to be added at the entrance.



Figure 35: Stabilised entranceway

Conditions where practice applies

This practice should be used at all points of construction site entry and exit with a view to limiting traffic movements to these entrances only.

Where necessary, this practice may be installed in association with shaker ramps or wheel-wash facilities, as close as possible to the boundary of the works area.

Limitations

Stabilised entranceways have the following limitations:

- They will reduce sediment movement but will not remove sediment from a vehicle. Care needs to be taken to implement other techniques, such as wheel wash or stabilised parking and turnaround areas within the site to maintain site traffic in a 'clean' state. This will reduce the potential for vehicles to transport sediment onto road surfaces
- The use of a wheel-wash system in association with a stabilised entranceway can be expensive, but will provide higher efficiencies in terms of sediment removal
- Site management of traffic (i.e. preventing vehicles becoming a source of sediment by creating stabilised site parking, turnaround and laydown areas inside the site) is generally more cost efficient and effective in preventing sediment being tracked offsite than a wheel wash
- Stabilised entranceways should not be located in areas of concentrated flows, or next to watercourses or stormwater catchpits.

Key design criteria

Formal design of stabilised entranceways is generally not required; although the following design principles are required for them to be an effective practice:

- Stabilised entranceways should be located at the permanent site entry/exit point
- Locate all stabilised entranceways so that vehicles cannot bypass these devices. Perimeter silt fences or bunds may assist in achieving this requirement
- Minimise the number of site exit points
- Show the locations of all site exits points on the ESC Plan
- Ensure the stabilised entrance drains back onto site. A speed hump can be used for this purpose
- Consider the length of time the site entry/exit will be in place and expected traffic volumes and types. For projects with longer durations or large numbers of vehicle movements on and off the site, it is often more cost efficient to seal the exits from the start of the project, rather than manage the constant maintenance often associated with a site exit
- Use the specifications in Table 9 and Figure 39 to design stabilised entranceways. Achieving these specifications on a small site may be difficult. For small sites' guidance refer to Section G2.0.

Table 9: Stabilised entranceway specifications

Design parameter	Specification
Aggregate size	50 - 150 mm washed aggregate
Minimum thickness	150 mm
Minimum length	10 m
Minimum width	4 m

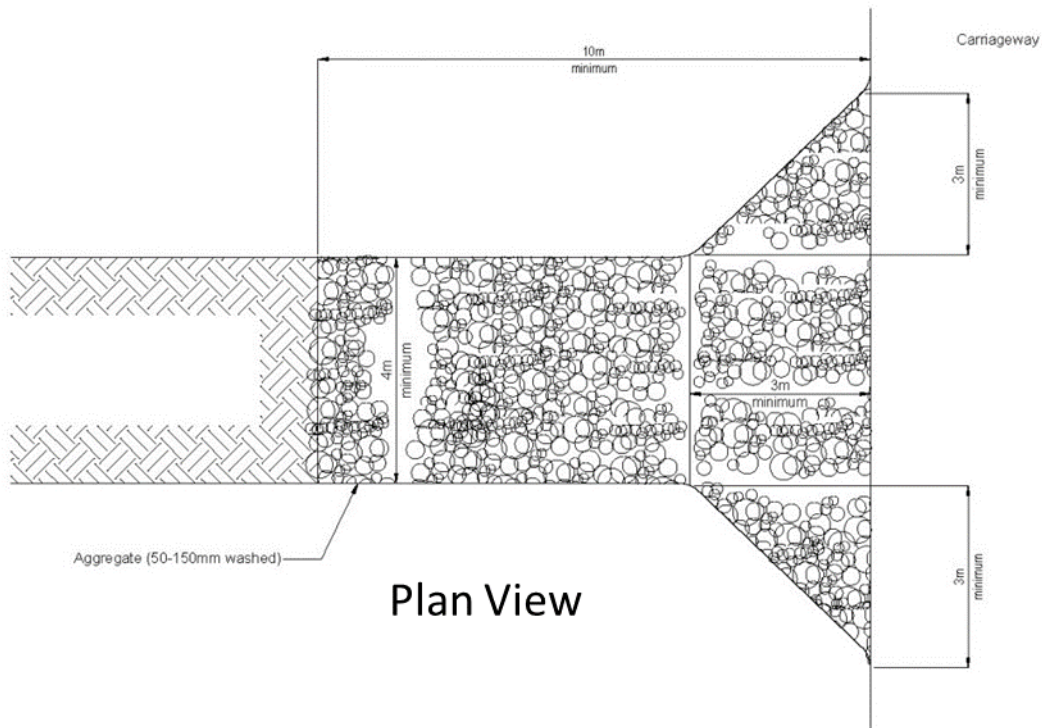
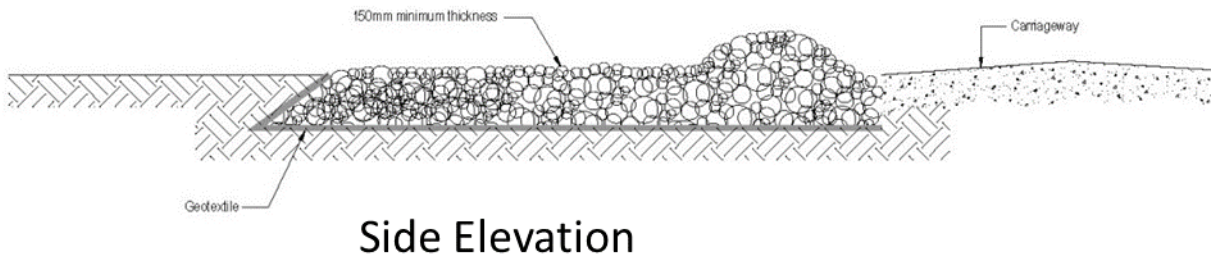

Figure 36: Stabilised entranceway

A shaker ramp could be in the form of a series of prefabricated "cattle stops" (refer Figure 37 and Figure 38). When stabilised entranceways are used with a shaker ramp, apply the following criteria:

- Design shaker ramps a minimum of 5 m long to allow at least one full revolution of a truck tyre
- Where using cattle stops, use two cattle stops placed one in front of the other to provide adequate length
- Ensure the 'teeth' of the shaker ramp are deep enough so that material dropped from one vehicle is not picked up by the next
- Stabilise the section of access road between the shaker ramp and the sealed pavement with rock
- Ensure the runoff from the shaker ramp area and/or wheel-wash systems passes through an appropriate sediment retention device.



Figure 37: Example of truck wash and shaker ramp

Note: Shaker ramps are only effective for minor volumes of dry material. Where the material to be removed is wet and/or located within the tyre treads, wheel washing will be required to remove this material.

When stabilised entranceways are used with a wheel wash, apply the following criteria:

- Ensure that a water collection and disposal methodology (such as water recirculation) is provided
- Direct wheel-wash runoff to an appropriate sediment retention facility within the site.



Figure 38: Example of a shaker ramp

E2.6.2 Construction, operation and maintenance

Construction and operation

For construction and operation of stabilised entranceways:

- Once a suitable location has been determined, clear the area of unsuitable material and grade the base to a smooth finish
- Place woven geotextile over this area and ensure this is appropriately pinned and overlapped as necessary
- Place aggregate from the construction site boundary extending for at least 10 m according to the specifications (Figure 36) and contour the aggregate to suit the entrance point (Note: Contouring can include a highpoint to act as a barrier to water flowing out of the site.)
- Provide drainage from the stabilised entranceway to an appropriate discharge point (This may require a sediment retention measure if a wheel wash is installed.)
- Consider the length of time the site entry/exit will be in place and the expected traffic volumes and types
- For projects with longer durations or large number of vehicle movements on and off the site, it is often more cost efficient to seal the exits at the commencement of works than to manage the constant maintenance often associated with a site exit.

Maintenance

Key items to check as part of the regular inspection include:

- Inspect weekly and after each rainfall event for general maintenance requirements
- Maintain the stabilised entranceway in a condition to prevent sediment from leaving the construction site (This may require several applications of new aggregate during the life of the practice.)
- After each rainfall, inspect any structure used to trap runoff from the stabilised entranceway and clean out as necessary
- When wheel washing is also required, ensure this is done on an area stabilised with aggregate/ Hotmix which drains to an approved sediment retention facility. (Note: This sediment retention device should be isolated from additional surface flows and/or be specifically designed to include the additional flows from the wheel wash.)
- Add further aggregate as necessary when mud blockage becomes evident or when aggregate thickness is not to specification
- Remove sediment from sealed pavements by sweeping or vacuuming as necessary
- Do not wash any sediment into the stormwater system or any watercourse
- Supplementary street sweeping at regular intervals on adjacent roads may still be required in association with stabilised entranceways.

E2.6.3 Decommissioning

In decommissioning stabilised entranceways, remove aggregate and geotextile, and stabilise the area. Ensure that traffic is kept off the area until permanent stabilisation is effective.

E2.7 Surface roughening

E2.7.1 Design

Definition

Surface roughening refers to the practice of roughening the surface of unstabilised (bare soil) earth surface; either with horizontal grooves across the slope, or by tracking with construction equipment (refer Figure 39 to Figure 41).

Purpose

Its purpose is to:

- Alter the construction surface soil profile to promote infiltration and increase flowpath lengths. It is a technique that will change the roughness coefficient and therefore, reduce the potential for sediment generation
- Help capture small quantities of sediment in the "hollows"
- Break up hard or compacted surfaces by ripping or scarification before seeding for either temporary or permanent revegetation programmes
- Trap seed and provide moisture sinks in the furrows, enhancing the establishment of vegetation.



Figure 39: Surface roughening with bulldozer

Conditions where practice applies

Surface roughening is a simple technique that should form part of any works methodology on slopes that have the potential to generate sediment discharges.

Limitations

Surface roughening has the following limitations:

- It is a short-term measure to minimise erosion, and is not a form of stabilisation
- It will not generally provide a satisfactory level of erosion control during high-intensity or long-duration rainfall events. Therefore, the technique cannot be relied on as the only form of control. It will require other devices to assist with the control of sediment from the site
- Ripping or scarification may allow water to enter dispersive soils or soils that are vulnerable to tunnelling, thereby exacerbating erosion

- Cut batters in highly erodible soils should not be roughened to the extent that scarification lines are likely to collect water in channels or rills
- Very dry, fine-textured soils should not be surface roughened, as they may be prone to pulverisation, making them more susceptible to detachment and transport by either wind or water.

Key design criteria

No formal design is necessary for the construction of surface roughening. However, the following principles apply:

- Intercept water that flows onto the works area and divert it away from the area(s) to be roughened prior to undertaking the works
- Fill existing rills before roughening a batter face. Roughening must be done up and down the face, so it leaves a cleat mark across the contour, as shown in Figure 40 and Figure 41
- Track-walking must leave well-defined cleat impressions in the soil, parallel to the contour
- This is necessary in order for the creation of a series of mound and hollow features to act as micro sediment traps
- When track-walking topsoil material, take care not to over-compact it so that the soil structure is not destroyed for plant and seed germination.



Figure 40: Surface roughening of a slope. Note the hollows acting as "micro" sediment traps

E2.7.2 Construction, operation and maintenance

Construction and operation

For construction of surface roughening:

- Intercept up-slope runoff water and divert it away from the area(s) to be roughened
- Fill existing rills before roughening or track-walking a batter face
- Undertake roughening up and down the face, so it leaves a cleat mark across the contour
- For track-walking, make well-defined cleat impressions in the soil, parallel to the contour or perpendicular to the slope (refer Figure 41)
- When track-walking topsoil material, take care not to over-compact it.

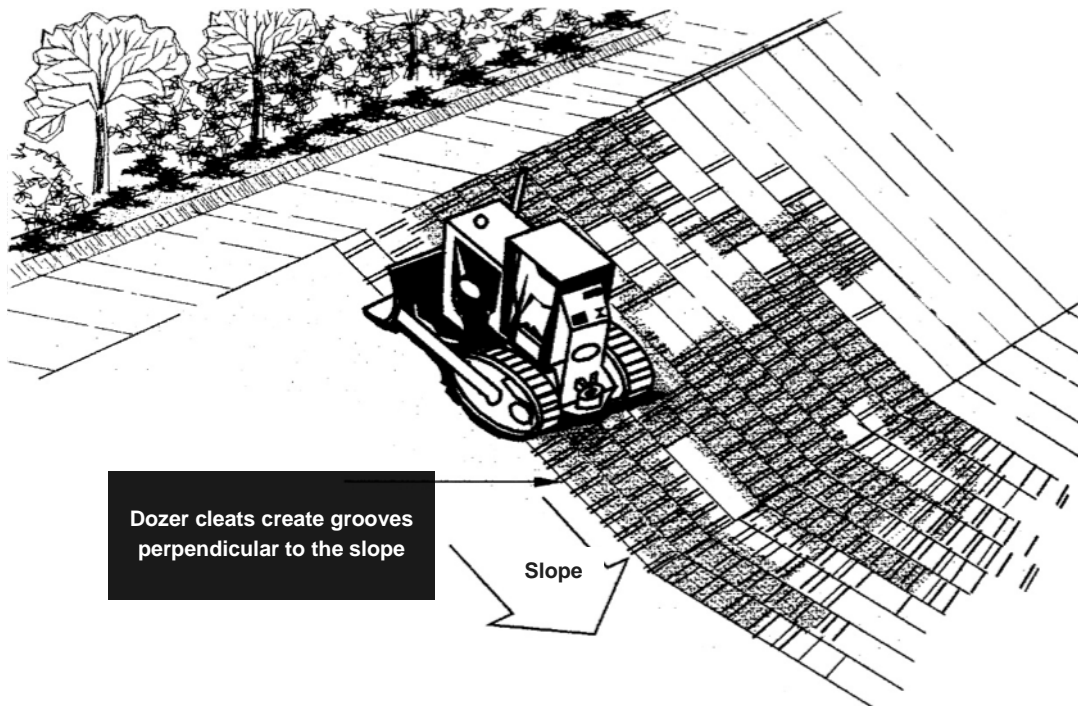

Figure 41: Surface roughening

Maintenance

To maintain surface roughening:

- Periodically check the slopes for signs of erosion (rills and channels)
- Rework and/or reseed the area as necessary.

E2.7.3 Decommissioning

There is no formal process for decommissioning surface roughening.

E3.0 Soil and surface stabilisation practices

A stabilised site is one that is resistant to erosion. Measures such as vegetative or structural practices will protect exposed soil and prevent erosion. This section focuses on temporary stabilisation for ESC purposes. Wider and more permanent geotechnical stabilisation may also need to be considered.

Common stabilisation measures include spreading of aggregate, grassing (with a full cover of grass), applying mulch/compost and the use of geotextiles (refer Figure 42).

Stabilisation techniques can be used either as a temporary or permanent measure against erosion. Some measures can be used for instant stabilisation (e.g. geotextiles, aggregate, mulch), whereas other measures (e.g. grassing) take longer before the area is appropriately protected against erosion.



Figure 42: Stabilisation via a combination of chip mulch, geotextile and aggregate

There are many geotextile types and products. These range from products that physically shed water, to those that incorporate seed and mulch and support vegetation, while protecting bare soil against erosion.

Where vegetation is used, the surface is considered stabilised once an 80% vegetative cover has been established over the entire revegetated area. Vegetation is effective in reducing runoff and can minimise the erosion potential of a construction site and reduce the need for structural practices. It is therefore important to retain as much of the existing vegetation as possible by limiting the extent of works.

Measures used for stabilisation purposes are set out in Sections E3.1 to E3.5. They comprise topsoil and grassing, hydroseeding, mulching, turfing, and the use of geotextiles. A section on dust control measures is also provided in Section G9.0. Guidance for each control/measure is split into the following subsections:

- Design
- Construction, operation and maintenance.

E3.1 Topsoiling and grass seeding

E3.1.1 Design

Definition

Seeding involves the planting and establishment of quick growing and/or perennial grass to provide temporary and/or permanent stabilisation on exposed areas (refer Figure 43). The practice is usually undertaken in conjunction with the placement of topsoil.

Purpose

The purpose is to provide either a short-term or long-term cover for erosion control on disturbed areas. Vegetation protects exposed soils from raindrop impact, reduces runoff velocity and volume and binds soil particles together.

Rapid-growing annual grass will provide a short-term cover. It is primarily used where project works are still progressing but need temporary coverage (e.g. during winter shutdown period).

Perennial grasses will provide permanent erosion protection to disturbed areas following completion of the earthworks' activity. Ideally, permanent grassing should be undertaken progressively throughout the project as areas are finalised and brought to final grade.

Topsoiling provides a suitable soil medium for vegetative growth for erosion control while providing some protection of the subsoil layer and also increasing the absorption capacity of the soil.



Figure 43: Grass stabilised earthworks site. Batter and building platforms

Conditions where practice applies

The practice applies to any site where vegetation establishment is important for stabilisation or landscape purposes.

Temporary and permanent seeding

- Use this on short to medium-term stockpiles, the outside of pond embankments or diversion bunds, on cut-and-fill slopes, access/haul road embankments and any other disturbed areas
- Used to establish vegetation and to protect bare earth. It may also be used on rough graded areas that will not be disturbed again for 12 months or more
- The main difference between temporary and permanent seeding is that permanent seeding is undertaken on completed sections of work. Additional differences are the seed type used and the quality of surface preparation undertaken prior to seeding.

Topsoiling

- Topsoiling is not a stabilisation measure itself and needs to be used in conjunction with temporary or permanent seeding. Topsoil provides growth media for root development and biological activities. It also has greater available water-holding capacity than clay subsoil layers
- Topsoiling is recommended for sites where:
 - The texture and/or the organic component of the exposed subsoil or parent material cannot produce adequate vegetative growth
 - The soil material is so shallow that the rooting zone is not deep enough to support plants or furnish continuing supplies of moisture and plant nutrients
 - High quality vegetative cover is required to be established.



Figure 44: Initial grass strike - not stabilised



Figure 45: Approximately 40-60% grass strike - not stabilised



Figure 46: Approximately 90 – 100% grass strike - stabilised

Limitations

Top soiling and grass seeding have the following limitations:

- Establishing a protective vegetative sward (expanse of grass) is difficult during periods of low rainfall or temperature extremes. Construction sequencing should be used to undertake topsoiling and seeding during optimum periods for vegetation establishment
- Seeds can wash away if not harrowed or held in place by mulch or hydroseed
- Grass seed that has not struck (refer Figure 44 and Figure 45) can be mobilised by intense rainfall and may require several applications to achieve the appropriate stabilisation standard
- Topsoil alone is not considered stabilised and other erosion/sediment control measures should be operational until there is an appropriate density of grass strike (minimum 80% cover, refer Figure 46). Alternatively, other stabilisation methods (e.g. mulching) may be used
- Achieving protective vegetative sward depends on a number of factors including soil types, seed types and weather conditions. This establishment period needs to be considered in erosion and sediment control planning (generally 4-8 weeks).

Key design criteria

Seedbed preparation

- If the site has contaminated material, this should be fully removed from the topsoil
- Topsoil should be applied at a minimum depth of 100 mm to allow for a loose and friable surface.

Soil amendments

- Apply fertiliser at the rate outlined in Table 10 of these guidelines. Check with your fertiliser supplier before using
- For large sites or unusual soil conditions, soil testing may be required, as some soils require the addition of lime to improve pH and/or trace elements for grass growth.

Seed application

- Seed mixes will vary, and a seeding contractor should be consulted before purchasing seed. Typical seed mixtures are detailed in Table 10
- Apply seed uniformly across the site. If hydroseeding is required, refer to Section E3.2. Traditional agricultural techniques such as drill seeding, broadcast seeding, or no tillage are appropriate for establishing grass on areas flatter than 25%. Ensure the methodology achieves a good seed-to-soil contact, thereby enhancing seed survival and germination rates
- For small areas, hand-broadcasting and raking may also be used to apply seed and fertiliser
- Use only fresh, certified seed with a high purity and germination percentage from reputable suppliers that are preferably local. Species selection must consider the project's ecological context. If permanent seeding is required, be mindful of the final landscape plans
- Apply establishment and maintenance fertiliser at the rate outlined in Table 10
- If irrigation is required, deliver a volume at least equal to the evapotranspiration rate and continue until natural rainfall provides the necessary soil moisture levels for plant survival
- Ensure that the site conditions and time of the year are appropriate for germination and vegetation establishment, prior to undertaking this activity. This may involve the placement of mulch and/or irrigation
- In order to maximise germination and growth rates, the preferred seeding windows for both temporary and permanent grassing are autumn and spring. With the use of mulch or geotextiles to maintain soil temperatures, or irrigation to supply moisture, grassing may be done throughout the year
- Mulching, as outlined in Section E3.4, should be undertaken in conjunction with the seeding programme during dry or cold periods. This will protect both the seed and the soil, whilst also providing a better microclimate for the germination and growth of grass
- A minimum 80% ground cover over the entire subject area is considered a stabilised surface. The above photos provide examples of various grass strike densities.

Table 10: Typical seed and fertiliser application rates

Typical seed mix		Application rate
Temporary seeding	Annual ryegrass	100-250 kg/ha
Permanent seeding	<ul style="list-style-type: none"> Perennial ryegrass - 70% Fescues/ cocksfoot - 20% 	200-400 kg/ha
	<ul style="list-style-type: none"> Clover/lotus - 5% 	
	<ul style="list-style-type: none"> Browntop - 5% 	
Fertiliser application	N:P:K (15:10:10)	200-800 kg/ha
Maintenance fertiliser	N:P:K (15:10:10) and Urea	As required

Note: In all circumstances, ensure that the seed and fertiliser application rates and mix is appropriate for your site. Always discuss with your seed and fertiliser supplier prior to utilisation.

E3.1.2 Construction, operation and maintenance

Construction and operation

Preparing a good seedbed will ensure the success of establishing vegetation. It should be loose, uniform and free of large clods and other objectionable material. The soil surface should not be compacted or crusted.

Topsoil is a valuable resource. When placing topsoil in stockpiles, ensure that it is isolated by the up-slope diversion of clean water runoff, is stabilised appropriately and not stored in stockpiles greater than 3 m in height to maintain soil structure and integrity.

Maintenance

- Check the topsoil condition on a regular basis and re-grade and/or replace where necessary
- Always maintain the 100 mm minimum depth of topsoil and appropriate surface roughening
- Heavy rainfall can wash new seeding away before full establishment of the grass (refer Figure 47)
- This is particularly evident on smoother hard surfaces, steep slopes and overland flow paths. Where vegetation establishment is unsatisfactory, the area will require a reapplication of seed or consideration will need to be given to other stabilisation techniques
- Apply additional fertiliser dosing at the ratio of 15:10:10 (N:P:K) approximately 6 to 12 weeks after seeding, or as required
- Protect all re-vegetated areas from construction traffic and other activities such as the installation of drainage lines and utility services. If required, erect temporary barrier fencing and/ or signage to restrict uncontrolled movement of equipment and vehicles onto grassed areas.



Figure 47: Loss of topsoil and grass seed after heavy rain event. Will require stabilisation and reapplication

E3.2 Hydroseeding

E3.2.1 Design

Definition

Hydroseeding is the application of seed, fertiliser and paper or wood pulp with water in the form of a slurry, which is sprayed over an area to provide for re-vegetation.

Purpose

Its purpose is to:

- Establish grass and other vegetation on steep and/or inaccessible areas
- Establish grass and other vegetation on surfaces with no or minimal topsoil.



Figure 48: Specialist application of hydroseed

The technique is designed to establish vegetation quickly. Hydroseeding is not considered instant stabilisation; although the practice will provide limited protection from raindrop impact for a short time until the grass is established.

Conditions where practice applies

This practice applies to any site where vegetation establishment is important for stabilisation or landscape purposes. Typically, it is used on:

- Critical areas such as steep slopes or batters and exposed areas near watercourses that require more rapid germination and stabilisation than conventional hand seeding
- Areas that may be difficult to establish by conventional sowing methods (e.g. steep embankments and areas with difficult access)
- Around or on runoff diversion channels/bunds, where rapid establishment of a protective vegetation cover is required before introducing water flow.

Limitations

Hydroseeding has the following limitations:

- It requires specialised equipment to apply (refer Figure 48). As a result, there is a reliance on experienced contractors and local knowledge to ensure that the seed mix is appropriate for the site and conditions
- During the winter stabilisation programme, the availability of hydroseeding contractors may be an issue. It is recommended that you plan your programme and confirm these contractors well ahead of time
- Newly established hydroseed can be mobilised by intense rainfall
- Until the vegetation has established, a hydroseeded area is not considered a stabilised surface (refer Figure 49 to Figure 51)
- Hydroseeding does not negate the need to water grassed areas. Watering needs to be carefully undertaken to avoid washing away the hydroseed.



Figure 49: Sports field being hydroseeded. Sediment control remains installed until an 80% grass strike has established

Key design criteria

There are various hydroseed mixes that use soil ameliorants (substances that aid plant growth), paper or wood pulp. In some circumstances, a binder is used to help seeds adhere to the soil surface.

Hydroseed mixes will vary greatly depending on the site-specific conditions and required outcome. Consultation with a hydroseeding contractor will be necessary to determine the seed mixes and application rates to achieve the required outcome.

Where hydroseeding is used as an erosion control measure, the area of coverage is not considered stabilised until an 80% density of grass cover has been established.



Figure 50: Recently applied hydroseed on a stormwater wetland

E3.2.2 Construction, operation and maintenance

Construction and operation

Consult with a hydroseeding contractor to ensure correct application.

Maintenance

- Heavy rainfall can wash new hydroseeding away before vegetation is fully established. This is particularly evident on smoother hard surfaces and overland flow paths. Where vegetation establishment is unsatisfactory, the area will require re-application of hydroseed, or consideration will need to be given to other stabilisation techniques
- Apply additional fertiliser dosing at the ratio of 15:10:10 (N:P:K) approximately 6 to 12 weeks after initial hydroseeding, or as required
- Water hydroseeded areas as necessary to promote growth, taking care to avoid washing the hydroseed away
- Protect all re-vegetated areas from construction traffic and other activities such as the installation of drainage and utility services.



Figure 51: Same wetland one week later, grass starting to take well

E3.3 Turfing

E3.3.1 Design

Definition

Turfing is the establishment and permanent stabilisation of disturbed areas by laying a continuous cover of grass turf (refer Figure 52 and Figure 53).

Purpose

Its purpose is to:

- Provide rapid stabilisation by the placement of vegetative cover to stabilise exposed areas
- Establish a vegetative filter or buffer along footpaths, driveways, kerbs, swales and channels.



Figure 52: Turf being placed adjacent to a stabilised swale

The practice provides instant results from a visual and erosion control perspective.

Conditions where practice applies

This practice is typically only used for:

- Critical erosion prone areas on the site that cannot be stabilised by conventional sowing or other stabilisation methods
- Runoff diversion channels and other areas of concentrated flow where velocities will not exceed the specifications for a grass lining
- Areas around grass stormwater inlets, swales, embankments, road berms and other areas that require immediate grass cover for landscaping purposes.

Limitations

Turfing can be a relatively expensive option to achieve a stabilised surface. However, it has the dual advantage of providing erosion control and landscaping of a feature.

Key design criteria

There are no specific design criteria for turfing; however, the following principles should be applied:

- Take care to ensure that flow velocities travelling over the turfed area will not cause erosion or undercut the turf. In these circumstances, which often relate to steeper areas, turf reinforced with geotextiles should be considered. Refer to the manufacturer's specifications for flow velocities applicable for the various geotextiles.
- The type of turf utilised needs to be suitable to the ground conditions and final use.

E3.3.2 Construction, operation and maintenance

Construction and operation

Preparing a good base will ensure the success of turf. It should be loose, uniform and free of large clods and other objectionable material. If turfing is placed during periods of high temperature, it must be irrigated immediately before placement. Lay turf on the contour; never up and down the slope. Start at the bottom and work up slope. Butt joints tightly and do not stretch or overlap.



Figure 53: Turf used to provide instant stabilisation of the swale allowing for early commissioning of the device

For slopes steeper than 3:1, secure turf to ground with pegs or other means.

Roll and tamp turf immediately to ensure solid contact with ground.

Maintenance

For maintenance of turfing:

- Water daily during the first week of laying the turf, unless there is adequate rainfall. Continue watering as appropriate to maintain good growth until fully established
- Check to ensure that the turf is firmly rooted to the original ground surface. Do not mow the area until the turf is firmly rooted
- Apply fertiliser as required in accordance with supplier's specifications.

E3.4 Mulching

E3.4.1 Design

Definition

Mulching is the application of a protective layer of straw or other suitable material to the soil surface (refer Figure 54 to Figure 56).

Purpose

Primarily, mulching is used as a rapid stabilisation technique to protect the soil surface from the forces of raindrop impact.

Mulch also helps to conserve moisture, retain warmth, reduce runoff and erosion, prevent soil crusting and promote the establishment of desired vegetation.

Mulching for erosion control purposes is usually a short to medium-term treatment. It can be used as a stand-alone surface cover or in conjunction with a seed and fertiliser grassing programme.



Figure 54: Specialist application of hay mulch

Although straw (wheat or barley) and hay are the commonly used materials, mulching can also include the application of bark, wood residue and wood pulp spread over the surface of disturbed ground.

Conditions where practice applies

Mulching can be used anytime where protection of the soil surface is desired; although the following conditions are applicable:

- Where it is critical to achieve an immediate stabilised surface cover and to maintain this cover for the short to medium term (3 - 5 months). This includes stabilisation of areas that have not been worked for a period of time, but are proposed to be worked in the future
- Where a warmer micro-climate is required to maintain soil temperatures, and soil temperature fluctuations need to be avoided. In turn, this provides appropriate conditions for seed germination and establishment of vegetation at most times of the year.

Limitations

The following limitations apply to mulching:

- It requires specialised equipment for large areas to enable uniform coverage. Hand mulching can occur on smaller areas
- Both hay and straw mulch have limited periods of effectiveness. In general, hay will last for three months and straw up to five months before these materials become part of the soil matrix and effective cover is lost
- Mulching may introduce weed species. In some circumstances, it may not be an appropriate measure for the site. Care needs to be taken to ensure that weed infestation of the mulched area does not create future issues
- In the period during the winter stabilisation programme, the availability of mulching contractors may be an issue. It is recommended that you plan your mulching programme and confirm mulching contractors well ahead of time
- Hay or straw mulch can be dislodged by intense rainfall or very high winds
- It is not an appropriate cover in areas of concentrated flow paths or in stream channel systems. Care is needed to ensure the mulch does not block flocculant treatment devices or interrupt the operation of decants in ponds
- The application of hay or straw mulch by blowing may not be practical next to motorways or other high traffic areas and adjoining residential areas. The potential limitations of this application should be considered in the overall erosion and sediment control planning.



Figure 55: Hydromulch application



Figure 56: Hydrohay as applied

Key design criteria

Rates for the application of mulch materials will vary. Consultation with mulching contractors will be required.

To be regarded as a stabilised area, the mulch product must provide complete cover of the area. Typical rates of application generally expected are as follows:

- Straw or hay mulch must be unrotted material and applied at a rate that provides a completed cover of the soil surface. This is typically in the order of 4,000 - 6,000 kg/ha. Mulch material should be relatively free of weeds and not contain noxious weed species. A list of noxious weeds can be obtained from Auckland Council
- Hydro-mulch applications must contain a minimum of 80% virgin or recycled wood and be applied in accordance with the manufacturer's specifications. The application rate will range from 2,200 - 2,800 kg/ha depending on the slope gradient. The coverage should not exceed slope lengths greater than 150 m
- Wood chip (refer Figure 57) can be applied at rates of around 10,000 - 13,000 kg/ha. Bark mulch is generally slow to deteriorate but can affect soil nitrogen levels, making it unavailable to plants. It can also result in leaching of saps and tannins, causing a change in pH. Care needs to be taken, therefore, when applying wood chip adjacent to watercourses and on steeper slopes
- If site conditions result in difficulties with the mulch material remaining on site (e.g. during windy conditions), it will need to be anchored. Forms of anchoring comprise:
 - **Crimping:** Using a tractor-drawn implement designed to punch and anchor mulch into the top 50 mm of the soil profile. On sloping land, crimping should be done on the contour whenever possible. (Note: Standard agricultural disks used for soil drying are not suitable for crimping; nor is crimping suitable on soft soils.)
 - **Binders or tackifiers:** These can be applied directly as the mulch is distributed, at an application rate that matches the manufacturer's specifications for that specific binder.



Figure 57: Woodchip to stabilise the finished batter slope

E3.4.2 Construction, operation and maintenance

Construction and operation

Stockpiles of woodchip need to be carefully managed to reduce risk of spontaneous combustion. Turn stockpiles over periodically to reduce the risk of heating occurring. In addition, discharge of tannins from the decomposition of woodchip should be addressed, as this can affect water quality.

Woodchip should be carefully managed around watercourses to avoid potential discharge.

Maintenance

Inspect mulch after each rainfall event or periods of excessively strong winds, replace any areas of damaged cover.

Construction equipment can disturb the stabilised areas. This may require the erection of temporary barrier fencing and/or signage to restrict movement of equipment and vehicles onto mulched areas.

To be regarded as stabilised, 100% surface cover must be maintained, and a reapplication will be required when the integrity and/or surface density has declined.

E3.5 Geotextiles and erosion control blankets

E3.5.1 Design

Definition

This practice involves the placement of geotextiles, mats, plastic covers or erosion control blankets to stabilise disturbed soil areas and protect soils from erosion by wind or water (refer Figure 58 to Figure 60). In this context, geotextiles are permeable fabrics which, when used in association with soil, have the ability to stabilise and protect.

Purpose

The purpose is to instantly reduce the erosion potential of the disturbed areas and/or reduce or eliminate erosion on critical sites. The practice may be used as a permanent or temporary measure to control erosion.



Figure 58: Geotextile used to temporarily stabilise the batter face

Conditions where practice applies

These measures are used when disturbed soils may be particularly difficult to stabilise, including the following situations:

- In critical erosion-prone areas such as sediment retention pond outlets and inlet points
- In channels (both perennial and ephemeral) where the design flow produces tractive shear forces greater than what existing soils can withstand, which leads to soil surface erosion
- In areas on a temporary basis where there is inadequate space to install sediment controls
- In areas that may be slow to establish an adequate permanent vegetative cover (In this situation, the geotextile provides an early protective layer and assists in maintaining a higher soil temperature.)
- On short steep slopes, on batters, or stockpiles during periods of inactivity on the site
- In situations where tensile and shear strength characteristics of conventional mulches limit their effectiveness, such as high runoff velocities and overland flow paths
- In areas where the downstream environment is of high value and rapid stabilisation is required.

Limitations

The practice has the following limitations:

- Blankets and mats are generally not suitable for excessively rocky sites
- If used in areas where the final vegetation will be mowed, the product must be 100% biodegradable, including the pins, to prevent issues with mowing in the future
- Temporary blankets and mats must be removed and disposed of prior to application of permanent soil stabilisation measures
- Geotextiles do not generally provide the same level of benefit to soil quality as many of the traditional mulches like straw mulch. Most geotextiles have a limited working life of generally no more than 9 to 12 months, and some materials may be prone to UV degradation
- Some geotextiles may contain a fine synthetic mesh or netting that can pose a threat to aquatic species when used for stream channel and bank stabilisation
- The use of plastic should be limited to covering stockpiles, or very small graded areas for short periods of time, until alternative measures such as seeding, and mulching are installed
- Geotextiles, mats, plastic covers and erosion control covers have maximum flow rate limitations; consult the manufacturer for proper selection
- Geotextiles can shift if installed incorrectly and need to be carefully placed with both pinning and wrapping to secure edging.

Key design criteria

The use of geotextile is typically categorised into temporary biodegradable geotextiles and permanent non-biodegradable geotextiles. The exception being plastic covers, which are a temporary, non-biodegradable measure for stockpile covering, as noted above.

Erosion control batter blankets are a specific group of proprietary rolled erosion-control products, commonly made from biodegradable materials. They provide an instant, short- to medium-term protective cover of the soil surface, shielding it from the erosive forces of wind, raindrop impact and sheet flows, until a vegetative cover can be established, or an alternative stabilisation methodology is used.

In all circumstances, for specific construction specifications, refer to the product information sheets supplied by the manufacturer.

In general, the minimum requirements for the various measures are as follows:

Non-woven geotextiles

Non-woven geotextiles are used as a temporary erosion control measure. They are useful for preventing raindrop erosion and scour from minor flows. Typical examples of their use include bund stabilisation, batter stabilisation, stockpile stabilisation, and low velocity channel stabilisation.

The main advantage of non-woven geotextiles is their ability to cling to the exposed surface. Their main disadvantage is their relative low strength. Where a high strength geotextile is needed (for instance in high flows), a woven geotextile should be used (refer below).

Woven geotextiles

A woven geotextile is used in high flow situations such as channels and flumes and as the upper fabric layer for pond spillways. For this, the woven geotextile must meet the following properties:

- Material should be a woven polypropylene fabric with a minimum wide width tensile strength ≥ 14 kN/m (AS, ASTM or ISO test methods allowed)
- The fabric should comply with a flow rate under 100 mm head of < 20 l/m²/sec (AS, ASTM or ISO test methods allowed)
- Retained strength at 500h UV = 70% Minimum (AS, ASTM or ISO test methods allowed)
- Correct use/installation of geotextiles is critical to achieving the desired outcome of erosion control
- Geotextiles should be secured in place with ground staples, pins or sandbags and keyed into the tops of slopes and edges to prevent infiltration of surface water under the geotextile
- Specifications for installation are outlined in Figure 59 and Figure 60. Particular care is needed to overlap and pin geotextiles in place
- In all circumstances, pin geotextiles down on a 500 mm (min) grid. This is critical to ensure an appropriate number of contact points with the underlying soil. It will also prevent wind from lifting the geotextile from the slope it is protecting
- Ensure that pins are suitable for the geotextile and soil type.

Plastic covers

- Plastic covers are used where needed to prevent water from penetrating into the material covered (e.g. contaminated stockpiles, or stockpiles of material for reuse)
- Plastic sheeting should have a minimum thickness of 0.25 mm. It should be keyed in at the top of the slope and held firmly in place with sandbags or other weights placed no more than 3 m apart
- Seams are typically taped or weighted down their entire length with at least a 300 mm - 600 mm overlap of all seams
- Edges should be embedded a minimum of 150 mm into the soil.

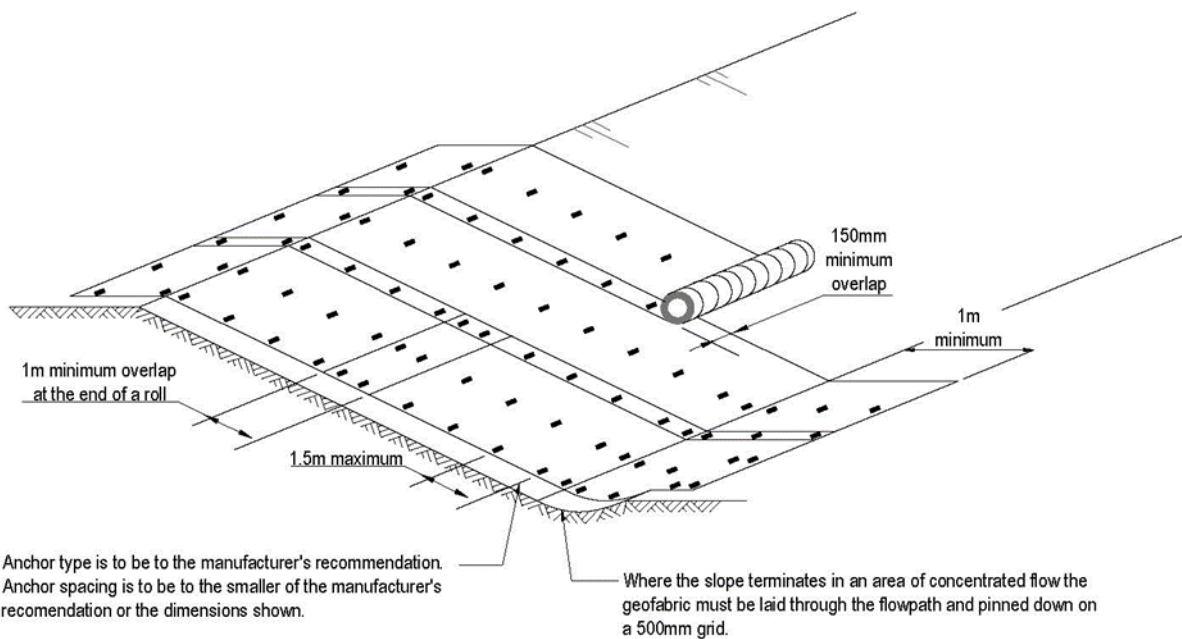

Figure 59: Geotextile design – outfalls

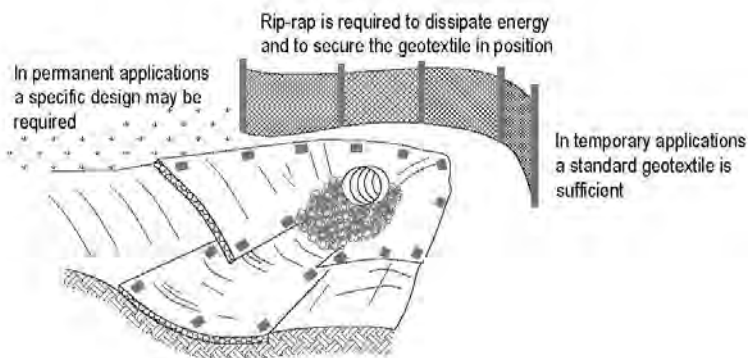



Figure 60: Geotextile design – on slopes

Erosion control blankets/mats

Key design criteria for erosion control blankets/mats are detailed in Table 11.

Table 11: Erosion control blankets/mats - design criteria

Material subtype	Design criteria
Biodegradable rolled erosion control products	
<p>All</p>	<ul style="list-style-type: none"> • Biodegradable rolled erosion control products are used where vegetation growth is required. They will provide stabilisation against raindrop erosion and low velocity flows until vegetation is established. • They typically comprise jute fibres, curled wood fibres, straw, coconut fibre or a combination of these materials. • For a product to be considered 100% biodegradable, the netting, sewing or adhesive system that holds the biodegradable mulch fibres together must also be biodegradable. • The following examples meet the above requirements and should be selected based on site-specific conditions and manufacturer's recommendations.
<p>Jute</p>  <p>Figure 61: Jute mesh</p>	<ul style="list-style-type: none"> • Jute (refer Figure 61) is a natural fibre that is made into a yarn, which is loosely woven into a biodegradable mesh. It is designed to be used in conjunction with vegetation with a life of approximately 1 year. • The material is supplied in rolled strips and needs to be secured to the soil with U-shaped staples or stakes in accordance with the manufacturer's recommendations.
<p>Straw blanket</p>  <p>Figure 62: Straw blanket</p>	<ul style="list-style-type: none"> • Straw blankets (refer Figure 62) should be machine-produced mats of straw with a lightweight biodegradable netting top layer. The straw should be attached to the netting with biodegradable thread or glue strips. The blanket should be of consistent thickness and the straw evenly distributed over the entire area of the blanket. • Straw blankets should be furnished in rolled strips a minimum of 2 m wide, 25 m long and 0.27 kilograms per square metre (kg/m²). • Staples should be U-shaped with 200 mm legs and a 50 mm crown.
<p>Wood fibre blanket</p>	<ul style="list-style-type: none"> • Wood fibre blankets are composed of biodegradable fibre mulch with extruded biodegradable netting held together with adhesives. The material is designed to enhance revegetation. • The material is furnished in rolled strips, which are secured to the ground with ground staples or pins in accordance with the manufacturer's recommendations.

Material subtype	Design criteria
Biodegradable rolled erosion control products	

Coconut fibre blanket

- Coconut fibre blankets (refer Figure 63) should be machine-produced mats of 100% coconut fibre with biodegradable netting on the top and bottom. The coconut fibre should be attached to the netting with biodegradable thread or glue strips. The blanket should be of consistent thickness and the coconut fibre evenly distributed over the entire area of the blanket.
- Coconut fibre blankets should be secured in place with ground staples or pins in accordance with the manufacturer’s recommendations.



Figure 63: Coconut fibre blanket used to stabilise batters while allowing grass to grow through

Coconut fibre mesh	<ul style="list-style-type: none"> • Coconut fibre mesh is a thin permeable membrane made from coconut or corn fibre that is spun into a yarn and woven into a biodegradable mat. It is designed to be used in conjunction with vegetation and typically has a lifespan of several years. • The material is furnished in rolled strips which are secured to the soil with ground staples or pins in accordance with the manufacturer’s recommendations.
--------------------	---

Material subtype	Design criteria
Non-biodegradable rolled erosion control products	

All

- Non-biodegradable products are a permanent erosion control measure that may have a benefit in a temporary situation of extended duration, such as a temporary stream diversion that will be in place for longer than 12 months.
- They typically comprise polypropylene, polyethylene, nylon or other synthetic fibres. In some cases, a combination of biodegradable and synthetic fibres is used to construct the material. Netting used to hold these fibres together is typically non-biodegradable as well.

Plastic netting

- Plastic netting is a lightweight biaxially-orientated netting designed for securing loose mulches such as straw to soil surfaces to establish vegetation.
- It is supplied in rolled strips and is photodegradable.
- The netting should be secured with ground staples or pins in accordance with the manufacturer’s recommendations.

Material subtype	Design criteria
Non-biodegradable rolled erosion control products	
Plastic mesh	<ul style="list-style-type: none"> • Plastic mesh is an open-weave geotextile composed of an extruded synthetic fibre woven into a mesh with an opening size of less than 50 mm. • It is used in combination with revegetation or to secure loose fibre such as straw to the ground. • The netting is supplied in rolled strips and should be secured with ground staples or pins in accordance with the manufacturer's recommendations.
Synthetic fibre with netting	<ul style="list-style-type: none"> • This comprises a mat of durable synthetic fibres treated to resist chemicals and UV light. The mat is a dense, three-dimensional mesh of synthetic fibres stitched between two polypropylene nets. • The mats are designed to be revegetated and provide a permanent composite system of soil, roots and geomatrix. • The netting is supplied in rolled strips and should be secured with ground staples or pins in accordance with the manufacturer's recommendations.
Bonded synthetic fibre	<ul style="list-style-type: none"> • Bonded synthetic fibre mats consist of a three-dimensional geomatrix nylon (or other synthetic) matting. Typically, they have more than 90% open area which facilitates root growth. • The mat's tough root reinforcing system anchors vegetation and protects against hydraulic lift and shear forces created by high volume discharges. • It can be installed over prepared soil followed by seeding into the mat (refer Figure 64). Once vegetated, it becomes an invisible composite system of soil, roots and geomatrix. • The netting is supplied in rolled strips and should be secured with ground staples or pins in accordance with the manufacturer's recommendations.
	

Figure 64: Bonded synthetic fibre mat used as erosion protection and medium for revegetation

Material subtype	Design criteria
Combination synthetic and biodegradable products	
All	<ul style="list-style-type: none"> • These products consist of biodegradable fibres such as wood fibre or coconut fibre with a heavy polypropylene net stitched to the top and a high-strength continuous filament geomatrix or net stitched to the bottom. • They are designed to enhance revegetation. • The material is supplied in rolled strips and should be secured with ground staples or pins in accordance with the manufacturer's recommendations.

E3.5.2 Construction, operation and maintenance

Construction and operation

Site preparation

- Undertake proper site preparation to ensure complete contact of the blanket or matting with the soil
- Grade and shape the area of installation
- Remove all rocks, clods, vegetation or other obstructions so that the installed blankets or mats will have complete and direct contact with the soil
- Prepare seedbed by loosening 50 mm to 75 mm of topsoil where seeding is proposed.

Seeding

- Seed the area before blanket installation for erosion control and revegetation
- Seeding after mat installation is often specified for turf reinforcement application. When seeding prior to blanket installation, all check slots and other areas disturbed during installation must be re-seeded.

Anchoring

- Ground staples, or pins can be used to anchor mats and blankets to the ground surface
- The selection of anchors will depend on a number of factors including whether the stabilisation is temporary or permanent (potentially requiring biodegradable pins) and soil conditions
- The selection of anchors will also depend on whether the blanket or matting will be subject to significant flow forces
- Ground staples and pins should be driven flush to the soil surface
- All anchors should have sufficient ground penetration to resist pullout. Longer anchors may be required for loose soils.

Installation on slopes

- Installation should be in accordance with each manufacturer's recommendations. In general, these will be as follows:
 - Begin at the top of the slope and anchor the blanket in a 150 mm deep by 150 mm wide trench. Backfill trench and compact earth firmly
 - Unroll blanket down-slope in the direction of the water flow
 - Downslope joins overlap should be at least 1 m
 - Overlap the edges of adjacent parallel rolls by a minimum of 150 mm
 - Pin spacing should be 500 mm for concentrated flow paths
 - When blankets must be spliced, place blankets end over end (shingle style) with 150 mm overlap. Staple through overlapped area, approximately 300 mm apart
 - Lay blankets loosely and maintain direct contact with the soil. Do not stretch
 - Staple blankets sufficiently to anchor blanket and maintain contact with the soil. Staples should be placed down the centre and staggered with the staples placed along the edges.

- Follow the manufacturer's recommendation for the spacing of the staples; although the staple densities in Table 12 generally apply.

Table 12: Staple density

Slope	Minimum staple density
> 50%	2.0 staples/m ²
50% to 33%	1.5 staples/m ²
< 33%	1.0 staples/m ²

Installation in channels

- Installation should be in accordance with the manufacturer's recommendations.

Maintenance

Areas treated with temporary soil stabilisation should be inspected daily and after each rainfall event. Areas treated with temporary soil stabilisation should be maintained to provide appropriate erosion control and reapplied or replaced on exposed soils when the area becomes exposed or exhibits visible erosion. The maintenance aspects to look for comprise:

- Lifting geotextile caused by vegetation growing up under the fabric
- Rilling caused by water flowing beneath the geotextile
- Torn geotextile, missing pins or other damage caused by high winds, machinery or vandalism.

Repair or replace any areas of geotextile damaged or dislodged in any way. If required, erect a temporary barrier and/or signage fencing to restrict uncontrolled movement of equipment and vehicles onto treated areas.



F Sediment control practices

Table of Contents

F1.0	Structural approaches	90
F1.1	Sediment retention ponds	90
F1.1.1	Design.....	90
F1.1.2	Construction, operation and maintenance.....	102
F1.1.3	Decommissioning	104
F1.2	Decanting earth bunds.....	105
F1.2.1	Design.....	105
F1.2.2	Construction, operation and maintenance.....	109
F1.2.3	Decommissioning	111
F1.3	Silt fences	111
F1.3.1	Design.....	111
F1.3.2	Construction, operation and maintenance.....	116
F1.3.3	Decommissioning	118
F1.4	Super silt fences	119
F1.4.1	Design.....	119
F1.4.2	Construction, operation and maintenance.....	122
F1.4.3	Decommissioning	124
F1.5	Silt socks	125
F1.5.1	Design.....	125
F1.5.2	Construction, operation and maintenance.....	128
F1.5.3	Decommissioning	129
F1.6	Stormwater inlet protection	130
F1.6.1	Design.....	130
F1.6.2	Construction, operation and maintenance requirements	132
F1.6.3	Decommissioning	132
F2.0	Coagulant and flocculant treatment	133
F2.1	General.....	133
F2.1.1	Definition.....	133
F2.1.2	Purpose	133
F2.1.3	Coagulation.....	133
F2.1.4	Flocculation.....	133
F2.1.5	Conditions where practice applies.....	134
F2.1.6	Limitations.....	134
F2.1.7	Treatment options.....	134

F2.2	Rainfall activated treatment	136
	F2.2.1 Design.....	136
	F2.2.2 Construction, operation and maintenance.....	139
F2.3	Batch dosing treatment	142
	F2.3.1 Design.....	142
	F2.3.2 Construction, operation and maintenance.....	142
F2.4	Decommissioning	143

Figures

Figure 65:	Schematic of a sediment retention pond.....	91
Figure 66:	A sediment retention pond cross-section	92
Figure 67:	Schematic of standard T-bar design	95
Figure 68:	Example of baffles	96
Figure 69:	Example of a level spreader	96
Figure 70:	Level spreader.....	97
Figure 71:	Example of an anti-seep collar	97
Figure 72:	Sediment retention pond for <1.5 ha catchment	98
Figure 73:	Sediment retention pond for 1.5 to 3 ha catchment	99
Figure 74:	Sediment retention pond for 3 to 5 ha catchment	100
Figure 75:	Installation of the outlet pipe and the anti-seep collars	102
Figure 76:	Level spreader across the full width of the pond.....	103
Figure 77:	Steel strapping used to attach decant system to horizontal pipework	103
Figure 78:	Decanting earth bund system and close up of T-bar dewatering device.	105
Figure 79:	Decanting earth bund	106
Figure 80:	Silt fence installed on edge of works.....	111
Figure 81:	Silt fence joins. Left hand photo shows battens used to join the lengths. Right hand photo shows doubling over of fabric at end around the waratah.....	111
Figure 82:	Schematic of a silt fence	114
Figure 83:	Silt fence cross-section	115
Figure 84:	Step-by-step installation of a silt fence.....	116
Figure 85:	Contours create the same effect as returns in this case	117
Figure 86:	Use of silt fence clips.....	117
Figure 87:	Super silt fence.....	119
Figure 88:	Schematic of a super silt fence	121
Figure 89:	Step-by-step installation of a super silt fence.....	123

Figure 90: Silt sock used to provide control during final landscaping	125
Figure 91: Compost silt socks with returns installed	128
Figure 92: Silt sock with 1 m overlapping joint	128
Figure 93: Silt sock joined using a sleeve and pegged and secured using bailing twine with 1 m overlapping joint.....	129
Figure 94: Straw sock secured in place using stakes and bale twine; note the stakes are placed every 600 mm	129
Figure 95: 'Turkeys nest'	129
Figure 96: Silt sock used to provide control during final landscaping works	129
Figure 97: Stormwater inlet protection silt fence within a construction yard	130
Figure 98: Good use of a silt fence installed to protect a new stormwater catchpit where impounded water will not create a flooding hazard.....	131
Figure 99: Installation of a silt sock to provide some protection to the catchpit	131
Figure 100: Rainfall activated flocculant treatment device	135
Figure 101: Rainfall activated treatment system	137
Figure 102: Rainfall catchment tray.....	137
Figure 103: Header tank.....	138
Figure 104: Flocculation shed	139

Tables

Table 13: Silt fence design criteria	113
Table 14: Super silt fence design criteria	120
Table 15: 300 mm diameter silt sock.....	126
Table 16: 450 mm diameter silt sock.....	127
Table 17: Specifications for compost.....	127

Preface

This section focuses on sediment control and describes structural and non-structural measures in accordance with the principles of ESC outlined in Section A2.0 of the guideline.

Along with erosion control measures, sediment retention devices are needed to capture runoff so mobilised sediment can settle out and be retained on site.

Guidance is provided (Sections F.1.1 to F.2.5) on the common measures to control sediment on earthworks sites. Guidance for each control/measure is split into the following subsections:

- Design
- Construction, operation and maintenance
- Decommissioning.

F1.0 Structural approaches

F1.1 Sediment retention ponds

F1.1.1 Design

Definition

A sediment retention pond (SRP) is a temporary pond formed by excavation, or by construction of an embankment. An outlet device is incorporated to dewater the pond at a rate that allows a high percentage of suspended sediment to settle out within the pond.

Purpose

The purpose of SRPs is to detain runoff flows so that deposition of transported sediment can occur through settlement. They also attenuate flows, thereby reducing downstream channel erosion effects.

Conditions where practice applies

SRPs should be used:

- Where treatment of sediment-laden runoff is required
- Where concentrated flows of sediment-laden runoff occur.

They are typically the most appropriate control measure for catchments greater than 0.3 ha.

Limitations

Limitations of SRPs are:

- Specific geotechnical design input may be required
- Location can impact on ease of on-going maintenance (particularly during winter) and decommissioning at completion of earthworks
- Specific design details may be required, including drawings, to ensure correct construction
- Catchment areas should be restricted to 5 ha. This limits the length of overland flowpaths, reduces maintenance, and limits the size of flocculant treatment devices.

Key design criteria

An SRP is an impoundment area formed by excavation or filling to form embankments. Embankments provide the required impoundment volume and shape. In practice, most are formed by a combination of excavation and filling. The maximum height of any filled embankment should not exceed 2.6 m. This height accommodates a maximum 2.0 m pond depth (base of pond to primary spillway), 300 mm freeboard from the primary spillway to the emergency spillway, and a further 300 mm depth of spillway. Exceeding this 2.6 m maximum height will increase the overall footprint of the SRP.

The following design criteria apply to SRPs (refer also Figure 65, Figure 66, and Figure 72 to Figure 74):

Size

- Size SRPs based on the contributing catchment area and slope length
- On earthwork sites with slopes < 18% and < 200 m in length, design SRPs with a minimum volume of 2% of the contributing catchment area (200 m³ for each ha of contributing catchment)
- On earthwork sites with slopes > 18% or > 200 m in length, design SRPs with a minimum volume of 3% of the contributing catchment area (300 m³ for each ha of contributing catchment)
- The above calculations define the total storage volume, which is measured from the base of the pond to the top of the primary spillway
- The slope angle is determined by the slope immediately (within 20 m) above the SRP, or by the average slope over the contributing catchment, whichever is greater. The slope angle should also be the greater of the pre- or post-construction slope.

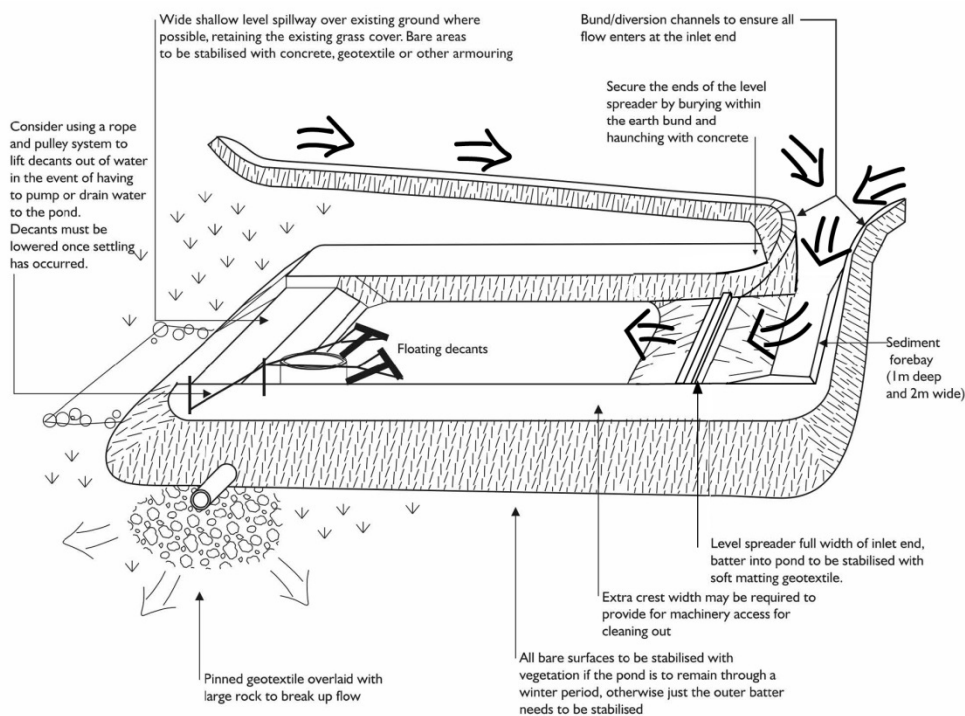
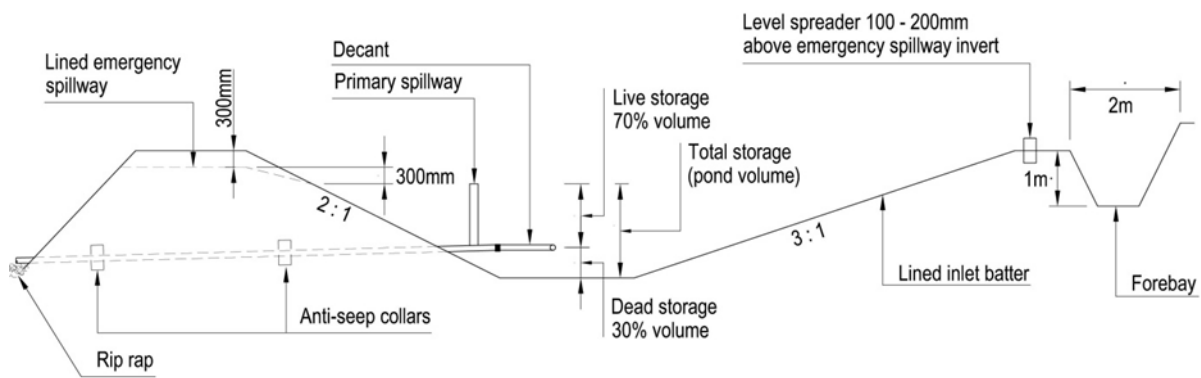

Figure 65: Schematic of a sediment retention pond



SRP Cross-Section

Figure 66: A sediment retention pond cross-section

Shape

- A critical component of the SRP's performance is the correct shape. The distance between the inlet and the outlet (including the emergency spillway) should be maximised to reduce risk of short-circuiting and to promote quiescent (inactive) conditions. If this cannot be achieved by correctly positioning of the inlet and outlets, install baffles to achieve the appropriate length-to-width ratio design
- Ensure the length-to-width ratio of the SRP is no less than 3:1 and no greater than 5:1. The length of the pond is measured as the distance between the inlet and the outlet (decant system)
- The length-to-width ratio is measured at the height of the primary spillway
- Ensure the SRP has a level invert as described in the following sections to promote even and gradual dissipation of the heavier inflow water across the full area of the pond
- Construction of the SRP invert with a reverse slope can aid maintenance by promoting heavier sediment to drop out and accumulate at the inlet end of the device
- For external batter steepness refer Figure 73 to Figure 75. For internal batters, a 2:1 ratio is recommended, subject to available space and ground conditions.

Depth

- SRP depths may be 1 – 2 m, but no deeper than 2 m. This depth is measured from the invert to the top of the primary spillway. Deeper ponds are more likely to cause short-circuiting problems during larger storm events and require specifically designed floating decant systems
- The decant design in this guideline operates through a maximum live storage range of 1.5 m.

Dead storage (permanent storage)

- Dead storage is the component of impoundment volume that does not decant and remains in the SRP. It is important for dissipating the energy of sediment-laden inflows
- Dead storage should be retained at 30% of the total SRP storage by positioning the lowest decant 0.4 - 0.8 m above the invert of the pond
- The decant design detailed in this guideline allows the lower decant arm to be raised as sediment deposition increases, thereby maintaining the percentage volume of dead storage.

Live storage (decant storage)

- Live storage is the volume between the lowest decant outlet level and the crest of the SRP primary spillway
- Live storage volume capacity should be 70% of the total SRP storage
- The decant design detailed in this guideline allows the decant arms to be raised as sediment deposition increases, thereby maintaining the percentage volume of live storage.

Forebay

- The forebay should extend the full width of the pond, be a minimum of 1 m in depth and 2 m in width and be located upstream of the level spreader.

Decanting/outlet dewatering device

- The SRP decant/outlet dewatering device should be designed to remove water within the upper water column without removing any of the settled sediment, or any appreciable quantities of floating debris. Either a 100 mm or 150 mm diameter decant can be used
- The floating T-bar dewatering device described in this guideline allows decanting of the cleaner surface water from the top of the water column
- To ensure that appropriate detention times are achieved, the recommended decant rate from an SRP is 3 L/second/ha of contributing catchment
- A standard T-bar design is detailed in Figure 67. This design provides a decant flow rate of 4.5 L/second, designed for a catchment of 1.5 ha. Decants are either added incrementally to accommodate catchments greater than 1.5 ha or the number of holes in the decant is restricted to maintain the decant rate of 3 L/second/ha of contributing catchment
- T-bars should be able to float to the top of the primary spillway at all times
- To achieve a decant rate of 4.5 L/second per decant, six rows of 10 mm diameter holes should be drilled at 60 mm spacings (200 holes) along the 2 m long decant arm
- For catchments of less than 1.5 ha, the appropriate number of holes should be sealed off to achieve a 3 L/second/hectare discharge rate
- Single T-bar decants must be able to operate through the full live storage depth of the SRP
- If two decant systems are required, the lower T-bar decant must operate through the full live storage depth of the SRP. The upper T-bar decant should operate through the upper 50% of the live storage depth of the SRP only

- If three decant systems are used, then the lower T-bar decant should operate through the full live storage depth and the second T-bar decant through the upper two thirds of live storage depth of the SRP. The upper T-bar decant should operate through the upper one-third of live storage depth of the SRP as detailed in Figure 74.
- For contributing catchments:
 - Up to 1.5 ha, use a 150 mm (minimum) outlet pipe
 - Between 1.5 ha and 3.0 ha, use a 150 mm (minimum) outlet pipe
 - Between 3.0 ha and 5.0 ha, use a 300 mm (minimum) outlet pipe.

Primary spillway

- The primary spillway is the vertical upstand or riser pipe to which the decant is connected. All SRPs require a piped primary spillway
- For contributing catchments:
 - Up to 1.5 ha, use a 150 mm (minimum) upstand as a primary spillway
 - Between 1.5 ha and 3.0 ha, use a 150 mm (minimum) upstand as a primary spillway
 - Between 3.0 and 5.0 ha, use a 1050 mm concrete manhole riser as a primary spillway
- The primary spillway should be a minimum 600 mm lower than the top of the SRP embankment and a minimum 300 mm lower than the emergency spillway crest. Ensure the riser and the discharge pipe connections are all completely watertight.

Emergency spillway

- An emergency spillway is essential for all SRPs
- They must be capable of accommodating the 1% AEP event without eroding
- The emergency spillway level should be a minimum 300 mm lower than the top of the SRP embankment
- The emergency spillway crest and downstream batter require a very high standard of stabilisation with well-compacted fill material
- When using geotextile for emergency spillway stabilisation purposes, the batter face must be smooth, and all voids eliminated. If geotextile is used, a needle punch geotextile is covered with a strong woven low permeability geotextile. Ensure the geotextile is pinned at 0.5 m centres over the full area of the emergency spillway
- Design the emergency spillway as a stabilised trapezoidal cross-section, with a minimum bottom width of 6 m, or the width of the pond floor, whichever is the greater; unless specific design calculations have confirmed a smaller emergency spillway will accommodate the 1% AEP event.

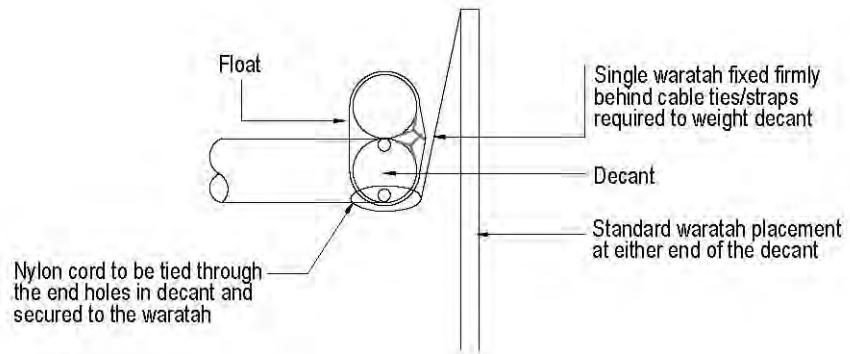
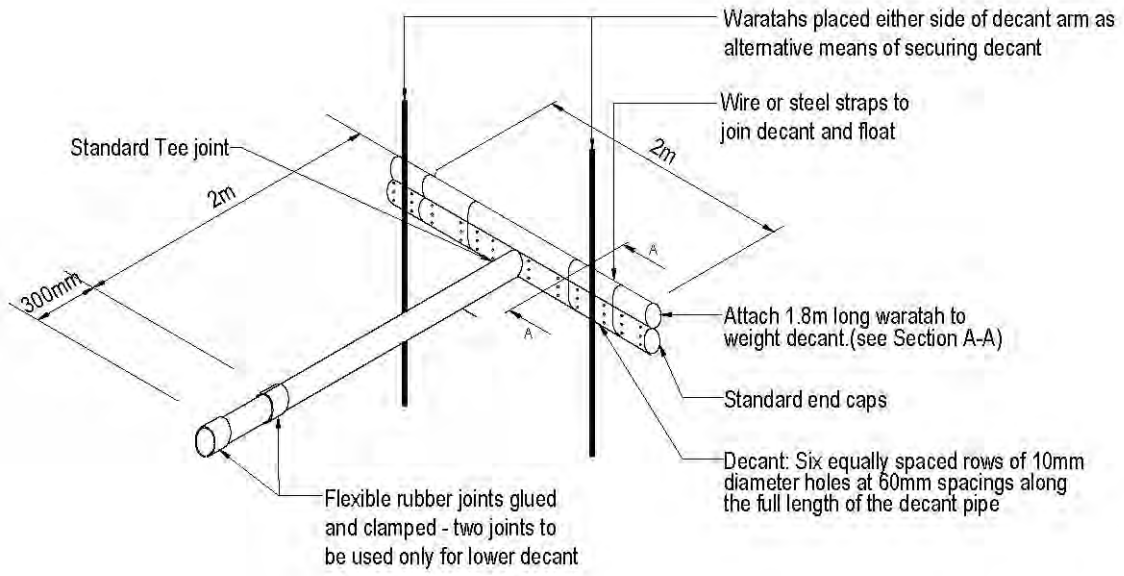

Figure 67: Schematic of standard T-bar design

Baffles

- Incorporate baffles (refer Figure 68) into the SRP design if the recommended pond shape cannot be achieved. Extend baffles the full depth of the pond and place them to maximise dissipation of flow energy. Effectiveness will be compromised if the inlet design and pond shape (length-to-width ratio) are designed incorrectly. Using baffles to achieve a length-to-width ratio will not achieve the optimum pond performance and should only be used where a compliant SRP design cannot be achieved.



Figure 68: Example of baffles

- Generally, baffles are in the form of a wing to direct inflows away from the outlet and maximise the stilling zone. A series of compartments within the pond can be used to achieve this, although care must be taken to avoid creating in-pond currents and re-suspension of fine sediment.

Level spreader

- Incorporate a level spreader (refer Figure 69 and Figure 70) into the inlet design to reduce inflow velocities and rapid dissipation of inflow energy. The inlet batter downstream of the level spreader must be well compacted and smoothed (no steeper than a 3:1 gradient) and stabilised over its entire area. It is essential to ensure the level spreader is level, non-erodible and spans the full width of the SRP
- To ensure even inflows, install a trenched and pegged 150 mm x 50 mm timber weir or similar across the full width of the inlet. Secure the ends of the timber weir with compacted earth and a concrete cover to prevent flows outflanking the weir. Install a concrete haunch along the edges of the level spreader to provide added structural strength. This timber weir also serves to toe in any geotextile protection that may be required. Sediment accumulated upstream of the level spreader may require periodic removal
- Position the top of the level spreader weir 100 – 200 mm above the invert of the emergency spillway.



Figure 69: Example of a level spreader

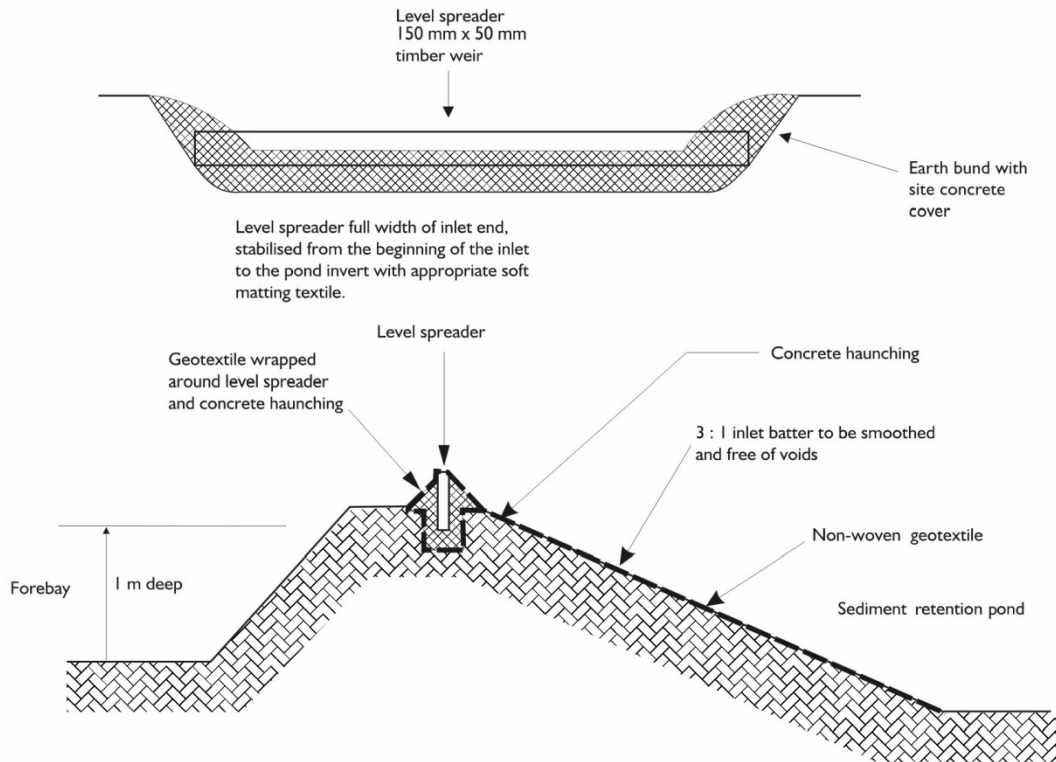

Figure 70: Level spreader

Anti-seep collar

- The discharge pipe should be laid at a 1 – 2% gradient and surrounded by compacted fill. Anti-seep collars (refer Figure 71) should be installed around the pipe with a spacing of approximately 10 m to increase the seepage length along the pipe. The vertical projection of each collar should be 500 mm. All anti-seep collars and their connections around the pipe must be watertight. Figure 72 provides a schematic of the anti-seep collar. Site-specific constraints may preclude certain features of this design.



Figure 71: Example of an anti-seep collar

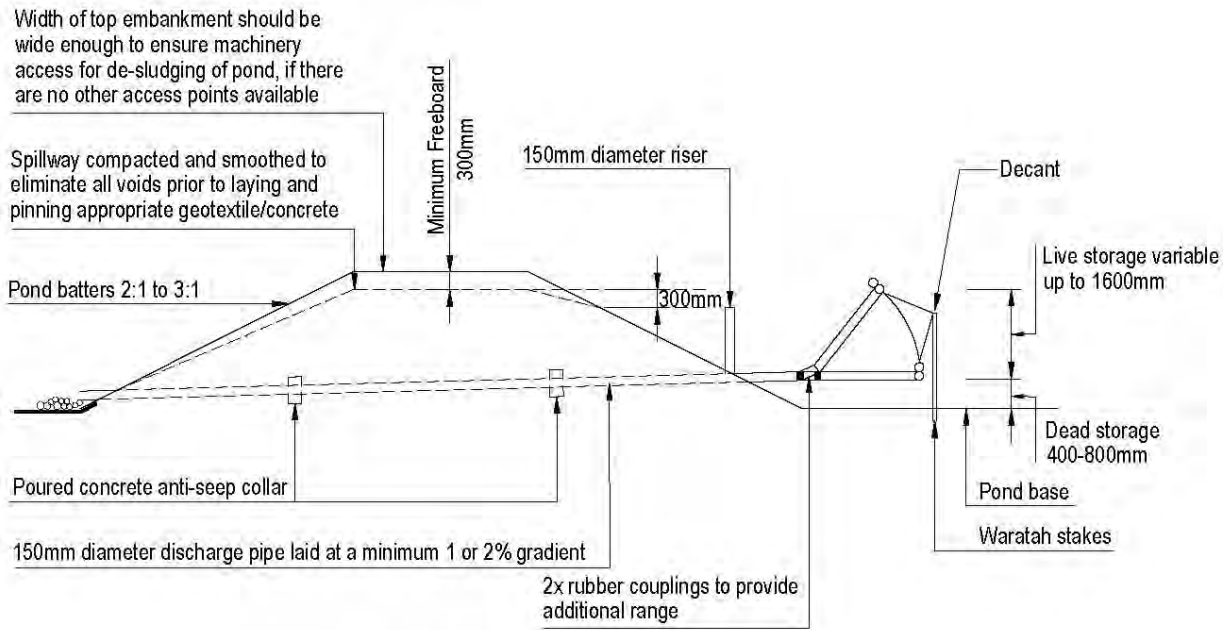

Cross - section

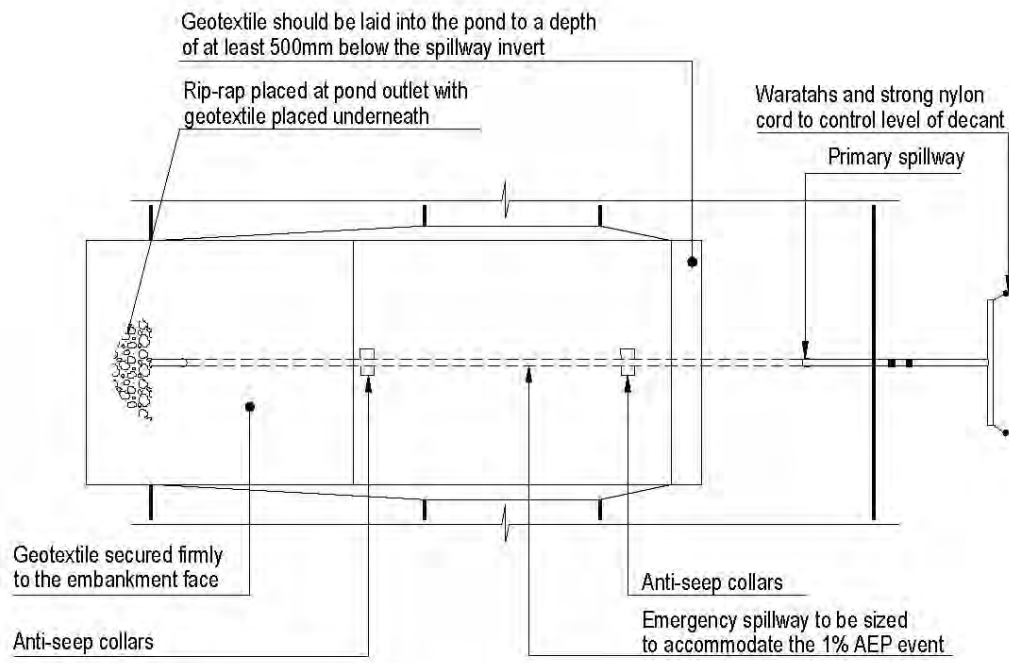

Plan

Figure 72: Sediment retention pond for <1.5 ha catchment

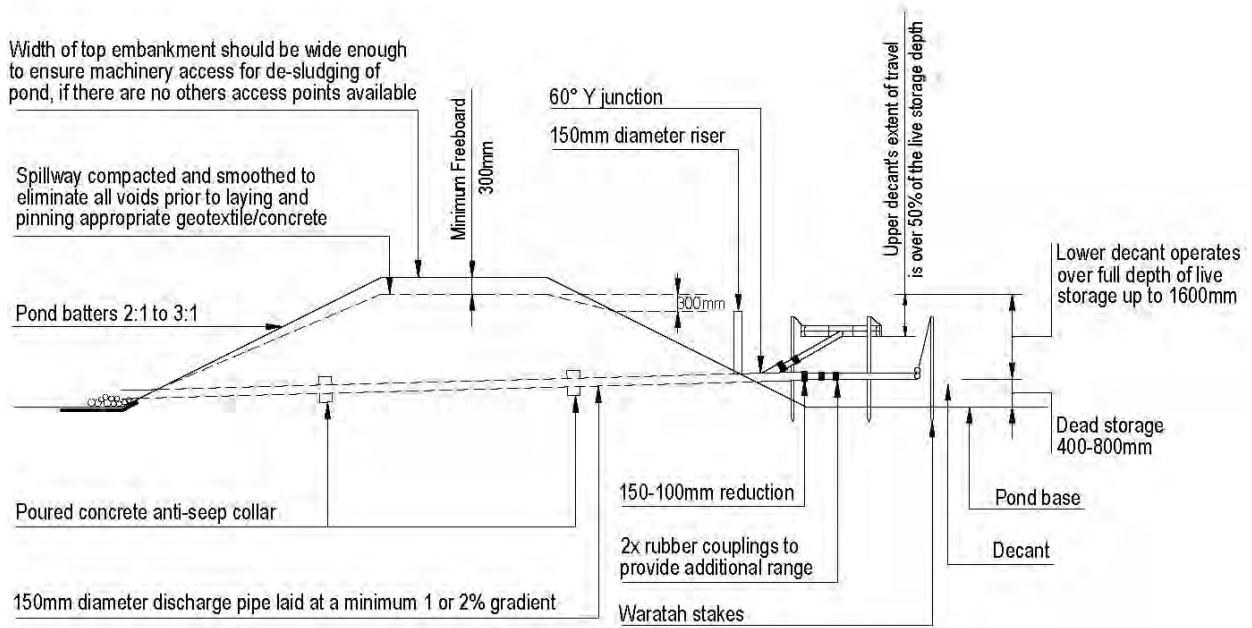

Cross - section

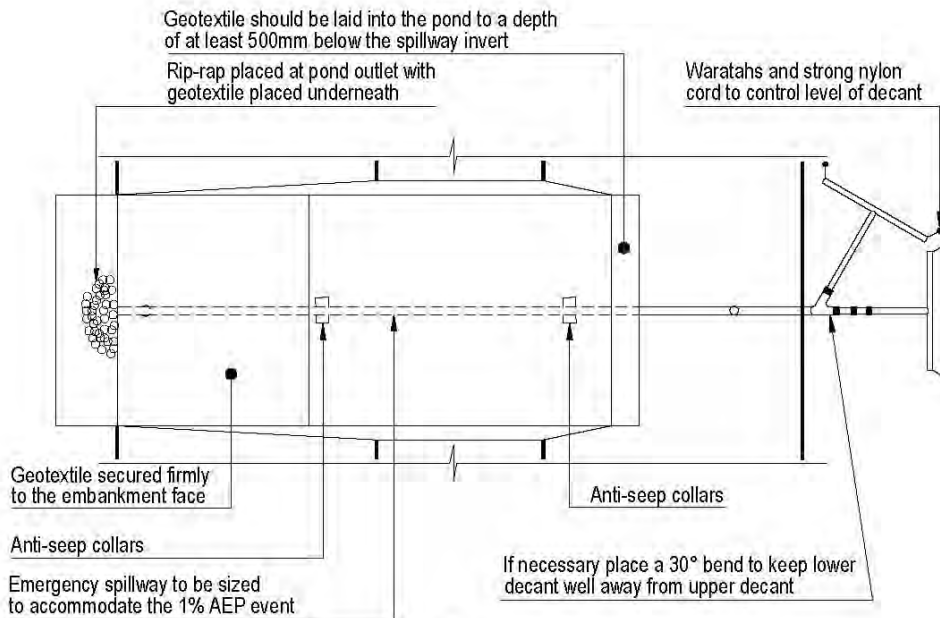

Plan

Figure 73: Sediment retention pond for 1.5 to 3 ha catchment

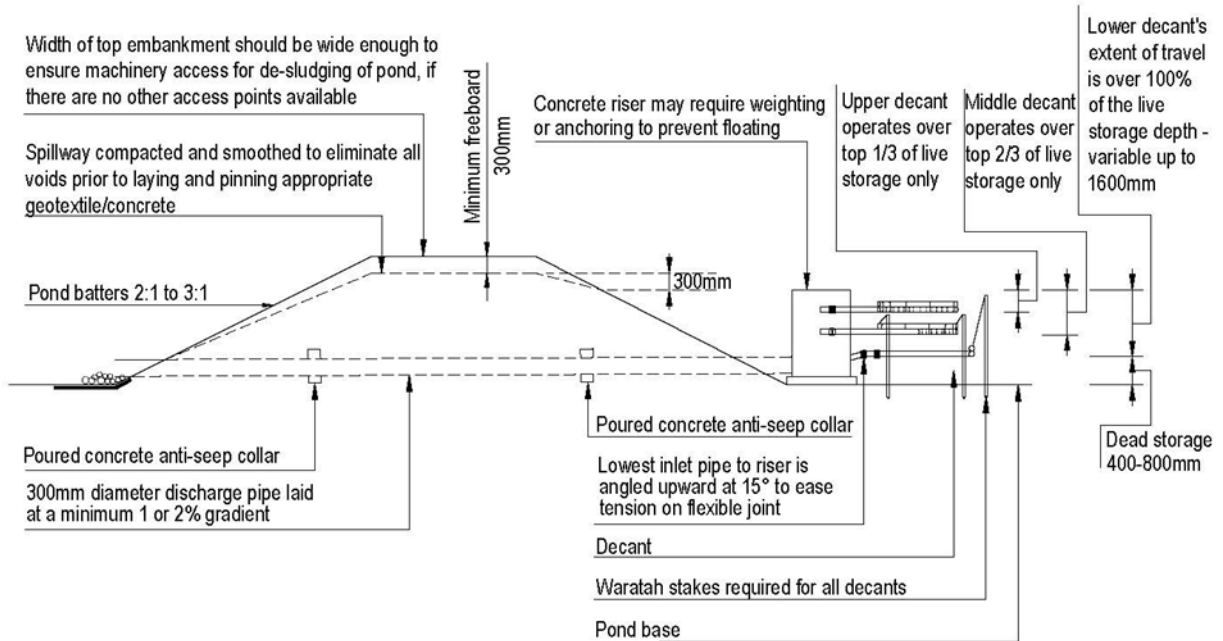

Cross-section

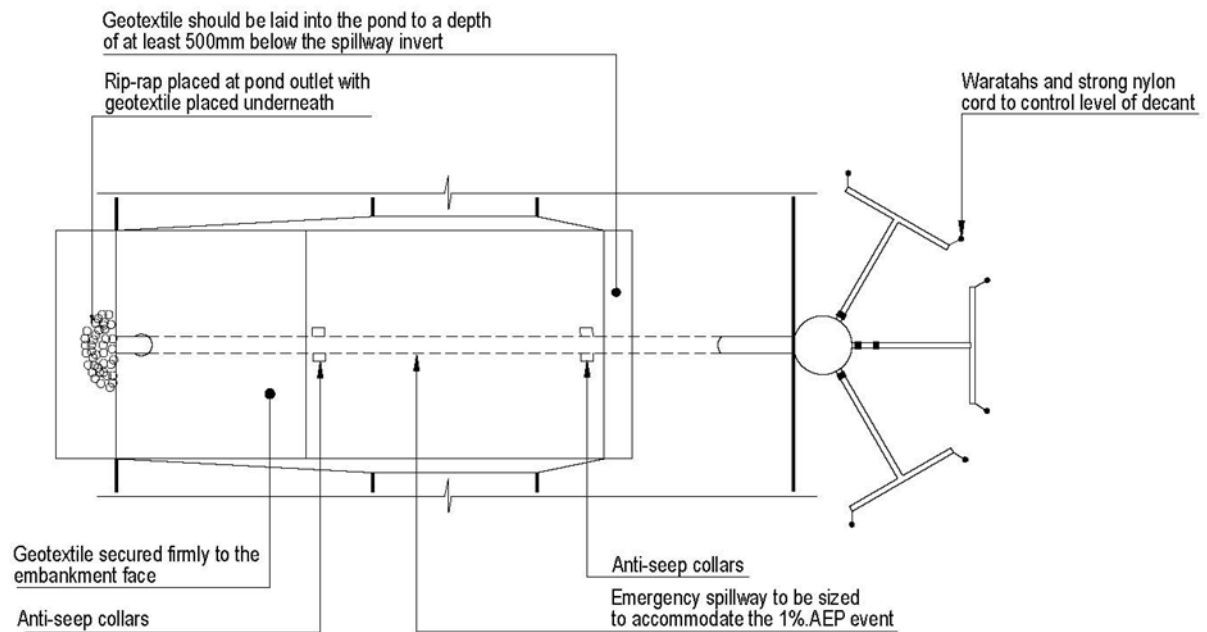

Plan view

Figure 74: Sediment retention pond for 3 to 5 ha catchment

Safety

SRPs can be a safety hazard if not appropriately fenced and if safety rules are not followed. Low gradient pond batters provide an additional safety measure (for access/egress). Check the safety requirements of Worksafe NZ. Refer Section C1.8.2 for further discussion on safety considerations.

Flocculant treatment

The majority of SRPs will require flocculant treatment.

Details of various flocculant treatment options are provided in Section F2.0 and Auckland Regional Council's Technical Publication, TP227 *The Use of Flocculants and Coagulants to Aid the Settlement of Suspended Sediment in Earthworks Runoff: Trials, Methodology and Design* (2004).

SRP potential modifications

The development of the SRP design promoted in this guideline has been supported by field trials that have confirmed the sediment retention efficiencies now adopted as the assumed minimum performance for the Auckland region. A number of additional measures and modifications have been developed and implemented by the earthworks industry since those original trials. The additional measures include:

- Geotextile stabilisation of the internal batters of the SRP
- Floating booms to reduce wave propagation and reduce maintenance to address blockage of T-bar holes by floating (organic) debris
- The use of additives other than PAC
- Baffles can be used to increase the length-to-width ratio of an SRP; however additional care is needed due to the typically narrow nature of the ponds. In practice, the use of baffles is often limited
- Consider baffles in the SRP design where the recommended shape cannot be achieved. Extend baffles the full depth of the pond and place them to maximise dissipation of flow energy
- Generally, baffles are in the form of a wing to direct inflows away from the outlet and maximise the stilling zone. A series of compartments within the pond can be used to achieve this; although care must be taken to avoid creating in-pond currents and re-suspension of light particulates.

F1.1.2 Construction, operation and maintenance

Construction and operation

For constructing and/or operating SRPs, follow the following general steps:

- Form clean-water diversion bunds to isolate the pond construction area
- Install a silt fence or other appropriate sediment control below the pond construction area
- Clear areas under proposed fills of topsoil or other unsuitable material
- Large fill embankments may need to be keyed in. Ensure that the embankments are constructed to appropriate engineering design standards
- Use only certified fill
- Place and compact fill in layers as per the engineering specifications
- Construct the base of the SRP with a reverse slope so heavier sediment drops out and accumulates at the inlet end of the device. This will assist with maintenance, specifically during regular desilting
- Do not place pervious materials such as sand or gravel within the fill material
- Construct fill embankments approximately 10% higher than the design height to allow for settlement of the material. Install appropriate pipe work and anti-seep collars during embankment construction and compact around these appropriately (refer Figure 75). Where possible, install the discharge pipes through the embankment once the embankment fill height provides sufficient cover over the pipe to continue filling once the discharge pipe has been installed
- Install the emergency spillway with a minimum of 300 mm freeboard height above the primary spillway. Where possible, construct emergency spillways in well-vegetated, undisturbed ground (not fill) and discharge over long grass. If the emergency spillway is to be constructed on bare soil, provide complete erosion protection by measures such as grouted rip-rap, asphalt, erosion matting/ geotextile or concrete. When using geotextile for emergency spillway stabilisation purposes, the batter face must be smooth, and all voids eliminated. If geotextile is used, a soft needle punch geotextile is laid first and then covered with a strong woven low permeability geotextile. Ensure the geotextile is pinned at 0.5 m centres over the full area of the emergency spillway
- Install and stabilise the level spreader (refer Figure 76)
- Construct the forebay (a level indicator can be installed to measure water level and sediment)



Figure 75: Installation of the outlet pipe and the anti-seep collars



Figure 76: Level spreader across the full width of the pond

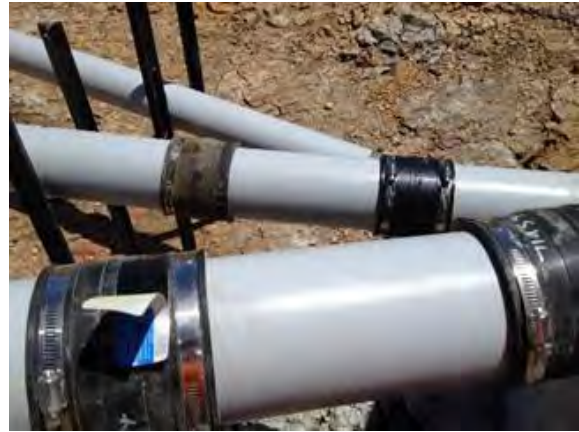

Figure 77: Steel strapping used to attach decant system to horizontal pipework

- For the decant system:
 - Attach the decant system securely to the horizontal pipework with steel strapping directly on top of the decant arm (refer Figure 77). This should be weighted to keep the decant arm submerged just below the surface through all stages of the decant cycle. This will also minimise the potential for blockage of the decant holes by floating debris. The most successful method is to weigh the decant arm by strapping a 1.8 m long waratah between the float and the decant (approximately 4 kg of weight). Make all connections watertight
 - Position the T-bar decant at the correct height by tying a 5 mm nylon cord through the decant holes at either end of the decant arm and fastening it to waratahs driven in on either side of the decant. T-bars should be able to float to the top of the primary spillway at all times
 - Use a flexible thick rubber coupling to provide a connection between the decant arm and the primary spillway or discharge pipe. To provide sufficient flexibility (such as is required for the lower decant arm), two couplings should be installed. Fasten the flexible coupling using strap clamps and glue. Self-tapping screws will provide added strength and robustness to the joint. Steel bands should be tightened with a socket rather than screwdriver and care should be taken to leave space between the ends of the PVC pipes within the coupling to allow the T-bar to flex
 - Where a concrete riser decant system is used, ensure the lower decant connection is angled upwards so that it bisects the angle that the decant operates through. This will reduce the deformation force on the coupling used
 - Where a concrete riser is used, ensure it is incorporated within the pond embankment to prevent it floating. Where this is not possible, use a suitable volume of concrete ballast in the base of the manhole to prevent flotation
 - Decants should include a mechanism to allow outflows from the SRP to be temporarily stopped. This is to facilitate flocculant treatment via batch dosing and as a contingency in the event of spill or discharge of contaminants. It will allow contaminated runoff to be retained and prevent it from discharging from the site. A rope and pulley system, to lift the decants above the SRP water level, is the preferred mechanism; however other options such as plumbing bungs, valves or screw on end caps can also be used subject to the specific details of each SRP
- Place any manhole riser on a firm foundation of impervious soil

- Lay the discharge pipe at a 1 – 2% gradient. The fill material should be compacted using a machine compactor and must incorporate anti-seep collars around the pipe to increase the seepage length along the pipe with a spacing of approximately 10 m. The vertical projection of each collar should be 500 mm, and they must be watertight including their connections
- Do not place pervious material such as sand or scoria around the discharge pipe or the anti-seep collars
- Install baffles, if required
- Fully stabilise the external batter face, by vegetative or other means, immediately after construction, in accordance with the site's approved ESC Plan
- Provide an all-weather access track for maintenance. Consider future maintenance. Construct a muck-out bund adjacent to the forebay if space for future desilting maybe an issue
- Install and commission flocculant treatment devices
- Certify the SRP to confirm all design criteria have been met. Rectify any deficiencies as required
- Install sediment-laden diversions to direct runoff to the SRP.

Maintenance

For maintenance of SRPs:

- Inspect SRPs daily and before and after each rainfall event
- Clean out SRPs before accumulated sediment volume of reaches 20% of the total SRP volume. To assist in gauging sediment loads, clearly mark the 20% volume height on the decant riser
- Clean out SRPs with high-capacity sludge pumps, or with excavators (long-reach excavators if needed) loading onto sealed tip trucks or to a secure bunded area where the sediment can dry
- Maintain access to the forebay at all times to allow removal of accumulated sediment. Clean out the forebay after each runoff event if there is any evidence of sediment deposition
- The ESC Plan should identify disposal locations for the sediment removed from the SRP. Deposit the sediment in a location that avoids direct discharge to receiving environments. Stabilise all disposal sites as required and approved in the site's ESC Plan. Provide all weather access for the desilting and secure bunded areas if the SRP is to operate throughout winter
- Immediately repair any damage to SRPs caused by erosion or construction equipment.

F1.1.3 Decommissioning

The decommissioning of an SRP should only occur once the contributing catchment has been fully stabilised or alternative appropriate sediment retention devices have been installed.

The following steps should be followed:

- 1) Dewater pond (refer Section G1.0)
- 2) Remove and correctly dispose of all accumulated sediment
- 3) Remove fabric, concrete, pipe and other construction materials
- 4) Backfill the pond, compact soil, and re-grade as required
- 5) Stabilise all exposed surfaces

F1.2 Decanting earth bunds

F1.2.1 Design

Definition

Decanting earth bunds (DEBs) are an impoundment area formed from a temporary bund or ridge of compacted earth (refer Figure 78 and Figure 79). They provide an area where ponding of runoff can occur, and suspended material can settle out before runoff is discharged.

Purpose

The purpose of a DEB is to detain runoff flows so that deposition of transported sediment can occur through settlement.

Conditions where practice applies

DEBs can be used where:

- Treatment of sediment-laden runoff is required
- Concentrated flows of sediment-laden runoff occur
- Soil types require flocculant treatment to improve efficiency
- The catchment area is too small for an SRP (generally less than 0.3 ha)
- Where the slopes of the contributing catchment and/or concentrated flows dictate that silt fences or super silt fences are not appropriate.

DEBs are particularly useful for controlling runoff after topsoiling and grassing before vegetation becomes established. They should be used a part of a treatment train approach.

Flocculant treatment

The majority of DEBs will require flocculant treatment.

Details of various flocculant treatment options are provided in Section F2.0 and Auckland Regional Council's Technical Publication, TP227 *The Use of Flocculants and Coagulants to Aid the Settlement of Suspended Sediment in Earthworks Runoff: Trials, Methodology and Design* (2004).



Figure 78: Decanting earth bund system and close up of T-bar dewatering device.



Limitations

DEBs have the following limitations:

- Specific geotechnical design may be needed to impound the required volumes of water (depending on geotechnical constraints)
- Their effectiveness is less on steeper slopes where runoff velocities are greater
- The recommended maximum catchment for DEBs is 0.3 ha.

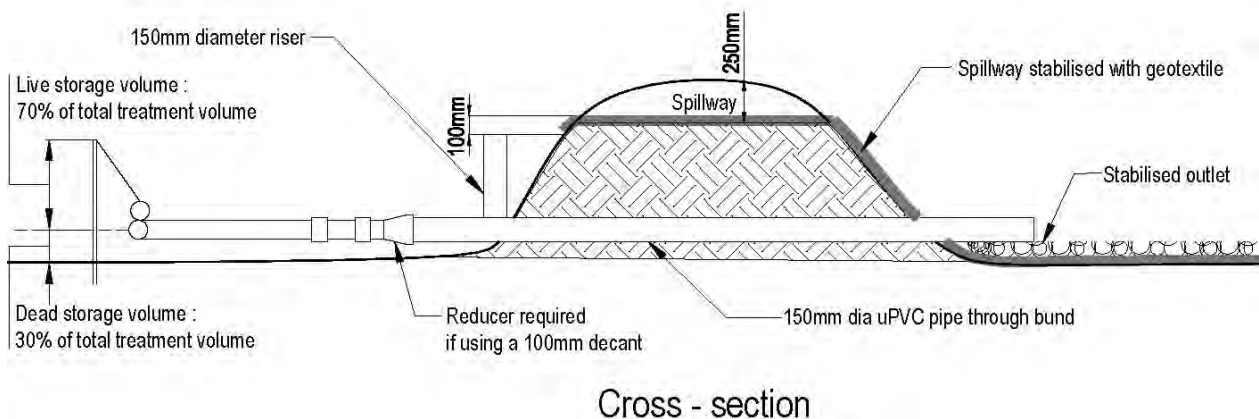

Figure 79: Decanting earth bund

Key design criteria

DEBs are often installed in challenging locations where achieving all of the following design criteria may be impractical. As these criteria are all interrelated, it is important that any compromise of these design criteria continues to achieve the following goals:

- To maximise the duration of settlement, maximise the volume of storage
- Reduce velocities through length-to-width ratios, and or baffles, to promote settlement
- Maintain an appropriate dead-water depth and volume to dissipate inflow energy, prevent re-suspension of settled sediment and provide storage of settled sediment
- Maintain an appropriate live-water depth and volume to promote settlement
- Ensure that the installed device is structurally sound and includes a stabilised spillway sized to accommodate the 1% AEP event without eroding.

Size

- DEB sizing is based on contributing catchment area
- Construct a DEB with a minimum volume of 2% of the contributing catchment area (20 m³ for each 1,000 m² of contributing catchment)
- The above calculation defines the total storage volume which is measured from the base of the DEB to the top of the primary spillway.

Shape

- To reduce the risk of short-circuiting and to promote quiescent (inactive) conditions, maximise the distance between the inlet and the outlet (including the emergency spillway)
- The base of a DEB should be a minimum of 2 m wide
- The length-to-width ratio of the DEB should be no less than 3:1 and no greater than 5:1
- The length-to-width ratio is measured at the height of the primary spillway
- The length of the DEB is measured as the distance between the inlet and the outlet (decant system). As a minimum, the inlet should be 5 m from the outlet
- Ensure that the DEB has a level invert to promote the even and gradual dissipation of the heavier inflow water across the full area of the DEB.

Depth of pond

- Limit the depth of DEBs to a maximum of 1 m embankment height. (Note: By excavating to form the dead-storage volume below existing ground level, the overall depth of DEB can be increased.)

Dead storage (permanent storage)

- Dead storage is the component of impoundment volume that does not decant and remains in the DEB. It is important for dissipating the energy of sediment-laden inflows
- Ensure dead storage is 30% of the total DEB storage by positioning the decant 0.30 – 0.40 m above the invert of the DEB.

Live storage (decant storage)

- Live storage is the volume between the decant outlet level and the crest of the DEB primary spillway
- Ensure that the live-storage volume capacity is 70% of the total DEB storage.

Decanting/outlet dewatering device

- Dewater the DEB to remove the water within the upper water column (live storage) without removing any of the settled sediment, and without removing any appreciable quantities of floating debris
- To dewater the DEB, use a floating T-bar dewatering device (as utilised in an SRP), which allows for the decanting of the cleaner surface water from the top of the water column. (Note: A 100 mm or 150 mm diameter T-bar device can be used. A standard T-bar design is detailed in Figure 67. There are also skimmers available (which float on the surface) or vertical upstands (traditional); however, the T-bar is the minimum standard.)
- The recommended decant rate from a DEB is 0.3 L/second/1,000 m² (or 3 L/second/ha) of contributing catchment. This rate ensures that appropriate detention times are achieved. (Note: This decant rate is equivalent to the decant rate described for a sediment retention pond in Section F1.1.)

- To calculate the number of holes (10 mm diameter) required to achieve the decant rate described above, allow 133 holes per 1 ha of contributing catchment (i.e. divide the number of ha of contributing catchment by 0.0075). The total number of holes is to be evenly divided among the number of decants
- The T-bar decant must be able to operate through the full live storage depth of the DEB
- Ensure that the T-bar decant float is securely fastened with steel strapping directly on top of the decant arm and weight it to keep the decant arm submerged just below the surface through all stages of the decant cycle. This will also minimise the potential for blockage of the decant holes by floating debris. The most successful method found to date is to weight the decant arm by strapping a 0.9 m long waratah between the float and the decant (approximately 2.0 kg of weight)
- Lay the 150 mm diameter discharge pipe at a 1 – 2% gradient, and compact the fill material around it using a machine compactor
- At the inlet end of the outlet pipe install a 90° Tee to accommodate the primary spillway. Install a 150 mm -100 mm reducer and short 100 mm section to provide a connection for the T-bar
- The decant should include a mechanism to allow outflows from the DEB to be temporarily stopped. This is to facilitate batch-dosed flocculant treatment and as a contingency in the event of spill or discharge of contaminants. It will allow contaminated runoff to be retained and prevent it from discharging from the site. A rope and pulley system, to lift the decant, is the preferred mechanism; however other options, such as plumbing bungs, valves or screw on end caps, can also be used subject to the specific details of each DEB.

Primary spillway

- All DEBs require a piped primary spillway
- Use a 150 mm upstand as a primary spillway
- The primary spillway should be a minimum 350 mm lower than the top of the DEB embankment and a minimum 100 mm lower than the emergency spillway crest. Ensure the riser and the discharge pipe connections are all completely watertight
- Geotextiles shall be fixed within the spillway structure in accordance with the manufacturer's specifications.

Emergency spillway

- An emergency spillway is essential for all DEBs
- Emergency spillways must be capable of accommodating the 1% AEP event without eroding
- Design the emergency spillway as a stabilised trapezoidal cross-section with a minimum bottom width of 1.5 m, unless specific design calculations have confirmed a smaller emergency spillway will accommodate the 1% AEP event
- Design the emergency spillway with a minimum of 100 mm freeboard height above the primary spillway
- Ensure that the emergency spillway has a minimum freeboard of 250 mm (between the invert of the spillway to the lowest point on the top of the bund).

Baffles

- As with SRPs, baffles can be used to increase the length-to-width ratio of a DEB; however additional care is needed due to the typically narrow nature of DEBs. In practice, the use of baffles is often limited
- Consider baffles in the DEB design where the recommended shape cannot be achieved. Extend baffles the full depth of the DEB and place them to maximise dissipation of flow energy
- Generally, baffles are in the form of a wing to direct inflows away from the outlet and maximise the stilling zone. A series of compartments within the pond can be used to achieve this; although care must be taken to avoid creating in-pond currents and re-suspension of light particulates.

Safety

DEBs can become a safety hazard if not appropriately fenced and if safety rules are not followed. Check the safety requirements of Worksafe NZ. Refer Section C.1.8.2 for further guidance on safety issues.

Flocculant treatment

Flocculant treatment should be used for all DEBs to increase their efficiency, unless other justification is provided. Details of various flocculant treatment options are provided in Section F2.0 and Auckland Regional Council's Technical Publication, TP227 (2004).¹

F1.2.2 Construction, operation and maintenance

Construction and operation

For construction and/or operation of DEBs, follow the following key steps:

- Form clean-water diversion bunds or drains to isolate the DEB construction area
- Install a silt fence or other appropriate sediment control below the DEB construction area
- Clear areas under proposed fills of topsoil or other unsuitable material down to competent material
- Consider whether large fill embankments need to be keyed in. Ensure that the embankments, including the foundations, comply with appropriate engineering design standards
- Use only approved fill
- Place and compact fill in layers as per the engineering specifications
- Do not place pervious materials such as sand or gravel within the fill material
- Construct fill embankments approximately 10% higher than the design height to allow for settlement of the material. Install appropriate pipe work during embankment construction and compact around the pipes appropriately. Where possible, install the discharge pipe through the embankment once the embankment fill height provides sufficient cover over the pipe to continue filling once the discharge pipe has been installed. Ensure that the backfill around the outlet pipe is impermeable

¹ Auckland Council TP227 *The Use of Flocculants and Coagulants to Aid the Settlement of Suspended Sediment in Earthworks Runoff: Trials, Methodology and Design*, June 2004

- Install the emergency spillway. The outer emergency spillway crest and batter require a very high standard of stabilisation. The fill material of the spillway batter should be well compacted. Where possible, construct emergency spillways in well-vegetated, undisturbed ground (not fill) and discharge over long grass. If the emergency spillway is constructed on bare soil, provide complete erosion protection by means such as grouted rip-rap, asphalt, erosion matting/ geotextile or concrete. When using geotextile for emergency spillway stabilisation purposes, the batter face must be smooth, and all voids eliminated. If geotextile is used, a soft needle punch geotextile is laid first and then covered with a strong woven low permeability geotextile. Ensure the geotextile is pinned at 0.5 m centres over the full area of the emergency spillway
- Attach the decant system securely to the horizontal pipework. Position the T-bar decant at the correct height by tying a 5 mm nylon cord through the decant holes at either end of the decant arm and fastening it to waratahs driven in on either side of the decant. Use a flexible thick rubber coupling to provide a connection between the decant arm and discharge pipe. To provide sufficient flexibility, install two couplings. Fasten the flexible coupling using strap clamps and glue. Make all connections watertight
- Do not place pervious material such as sand or scoria around the discharge pipe
- Install baffles, if required
- Fully stabilise the external batter face, by vegetative or other means, immediately after construction in accordance with the site's approved ESC Plan. Ensure all bare areas associated with the DEB are stabilised with vegetation, if the DEB is to remain in place over winter
- Provide an all-weather access track for maintenance
- Install and commission any flocculant treatment devices
- Produce an as-built to confirm all design criteria have been met. Rectify any deficiencies, as required
- Install sediment-laden diversions to direct runoff to the DEB.

Maintenance

To maintain DEBs:

- Inspect DEBs daily and before and after each rainfall event
- Clean out DEBs before the volume of accumulated sediment reaches 20% of the total DEB volume. To assist in gauging sediment loads, consider installing a marker post
- Clean out DEBs with high capacity sludge pumps, or with excavators (long reach excavators if needed), loading onto sealed tip trucks or to a secure area
- The ESC Plan should identify disposal locations for the sediment removed from the DEB. Deposit the sediment in such a location so that it does not lead to a direct discharge to receiving environments. Stabilise all disposal sites as required and approved in the site's ESC Plan
- Immediately repair any damage to DEBs caused by erosion or construction equipment.

F1.2.3 Decommissioning

DEB decommissioning occurs once the contributing catchment has been fully stabilised or alternative appropriate sediment retention devices have been installed.

The key steps for decommissioning comprise:

- 1) Dewater the DEB (refer Section G1.0)
- 2) Remove and correctly dispose of all accumulated sediment
- 3) Remove fabric, concrete, pipe and other construction materials
- 4) Backfill the DEB and compact soil, re-grade as required
- 5) Stabilise all exposed surfaces.

F1.3 Silt fences

F1.3.1 Design

Definition

A silt fence is a temporary barrier of woven geotextile fabric that is used to capture mainly coarse sediments carried in sheet flow (refer Figure 80 to Figure 83). Silt fences temporarily impound sediment-laden runoff, slowing down the flow rate and allowing sediment to settle out of the water.

Purpose

Its purpose is to detain runoff flows so that deposition of transported sediment can occur through settlement. They are not used to filter sediment out of runoff.



Figure 80: Silt fence installed on edge of works



Figure 81: Silt fence joins. Left hand photo shows battens used to join the lengths. Right hand photo shows doubling over of fabric at end around the waratah

Conditions where practice applies

Use silt fences:

- Where there is a need to control sediment by intercepting sheet flow
- Where a site is low gradient, or is confined with a small contributing catchment, such as short batter fills and around watercourses
- To delineate the limit of disturbance on an earthworks site, such as riparian areas or bush reserves
- Where installation of an earth or topsoil bund would destroy sensitive areas, such as bush and wetlands.

Do not install silt fences across watercourses or in areas of concentrated flows. Avoid trench excavations within the root zones of protected trees and trees that are to be retained.

Where there is a change in slope, no section of the fence should exceed a grade of 5% for a distance of more than 15 m.

Limitations

The following limitations apply to silt fences:

- Silt fences do not capture many soil particles finer than 0.02 mm in diameter (e.g. fine silts and clays) due to the short detention time of water behind the silt fence and relatively large pore size of most fabrics
- Pores in the silt fence fabric can become clogged relatively quickly with fine textured sediments, making the fabric impermeable. Consequently, additional reinforcing (such as chain link fence – super silt fence) might be required (refer Section F3.0 for super silt fences)
- Silt fences should only be used for sheet flows, not concentrated flows. Do not use silt fences as checks dams in channels (to reduce velocities) or place them where they will intercept concentrated flows
- Silt fences are best used a part of a treatment train approach.

Key design criteria

Key design criteria for silt fences are outlined below:

- Ensure silt fence height is 600 mm above ground level and 200 mm below ground level
- Maximum slope lengths, spacing of returns and angles for silt fences are shown in Table 13
- Locate supporting posts/waratahs for silt fences 2-4 m apart with support provided by a tensioned wire (2.5 mm HT) along the top of the silt fence
- Where a strong woven fabric is used in conjunction with a wire support, the distance between posts can be up to 4 m. Double the silt fence fabric over and fasten to the wire with silt fence clips at 500 mm spacings
- Ensure supporting posts/waratahs are embedded a minimum of 400 mm into the ground

- Always install silt fences along the contour (at a break in slope). Where this is not possible, or where there are long sections of silt fence, install short silt fence returns (refer Figure 82) projecting up-slope from the silt fence to minimise the concentration of flows. Silt fence returns should be a minimum 2 m in length and can incorporate a tie-back. They are generally constructed by continuing the silt fence around the return and doubling back, eliminating joins
- Join lengths of silt fence by doubling over fabric ends around a waratah or by stapling the fabric ends to a batten and butting the two battens together as shown in Figure 83
- Install silt fence returns at either end of the silt fence, projecting up-slope to a sufficient height to prevent outflanking
- In catchments of more than 0.3 ha, the use of silt fences requires careful consideration of specific site measures. Other control measures may be better, such as a super silt fence (refer Section F1.4).

Table 13: Silt fence design criteria

Slope steepness %	Slope length (m) (maximum)	Spacing of returns (m)	Silt fence length (m) (maximum)
Flatter than 2%	Unlimited	N/A	Unlimited
2 – 10%	40	60	300
10 – 20%	30	50	230
20 – 33%	20	40	150
33 – 50%	15	30	75
> 50%	6	20	40

- Where water may pond regularly behind the silt fence, provide extra support for the silt fence with tie-backs from the silt fence to a central stable point on the upward side. Extra support can also be provided by stringing wire between support stakes and connecting the filter fabric to this wire
- As a minimum, the silt fence cloth must meet the following criteria for geotextile fabric:
 - Wide width tensile strength = ≥ 14 kN/m minimum (AS, ASTM or ISO test methods allowed)
 - Retained strength at 500h UV = 70% minimum (AS, ASTM or ISO test methods allowed)
 - Opening size (EOS) = 0.2-0.4 mm (AS, ASTM or ISO test methods allowed).

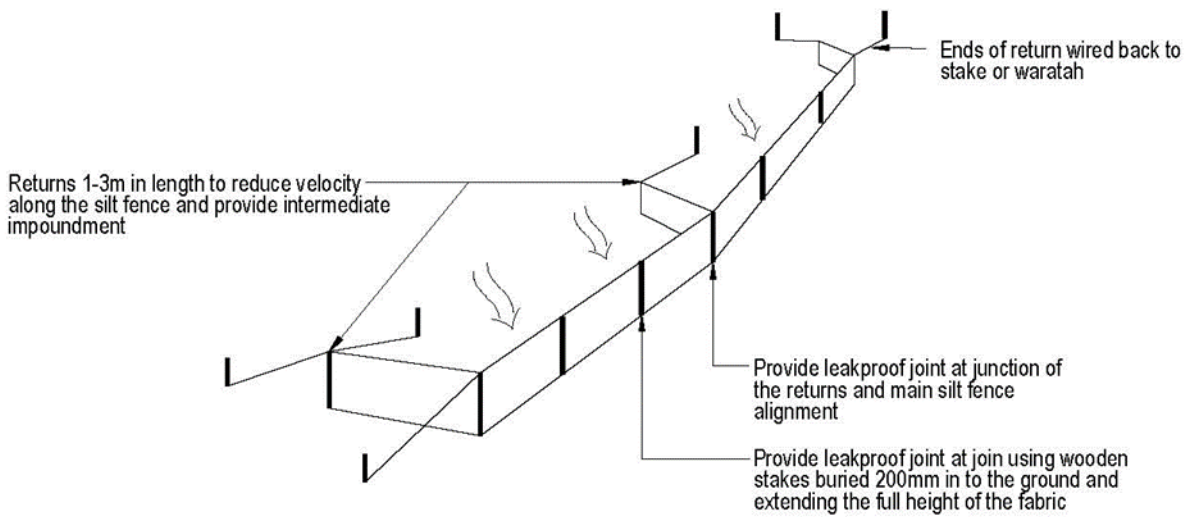
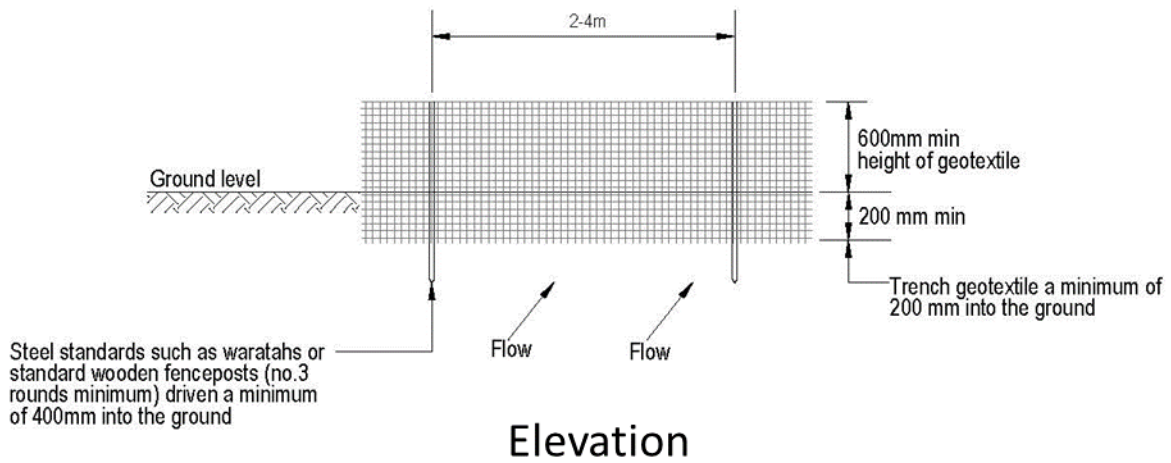
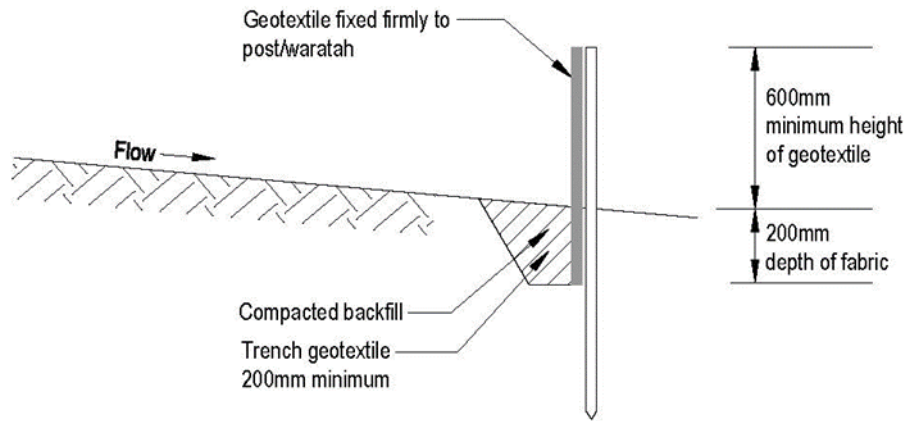
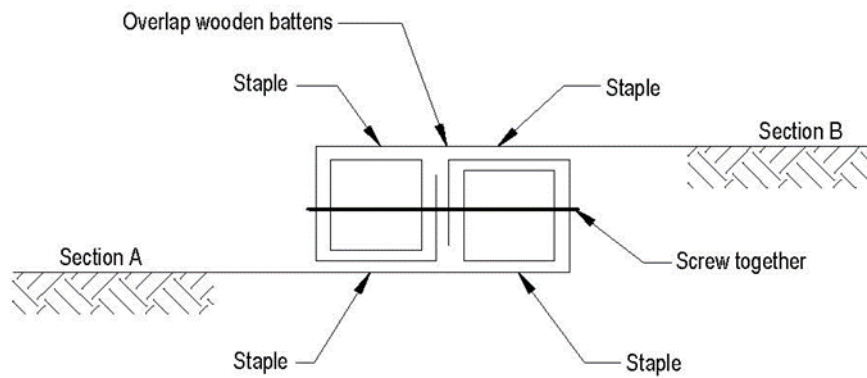

Figure 82: Schematic of a silt fence



Cross-section



Standard fabric joint

Figure 83: Silt fence cross-section

F1.3.2 Construction, operation and maintenance

Construction and operation

For constructing and/or operating silt fences, follow the following steps and refer to Figure 84 below:

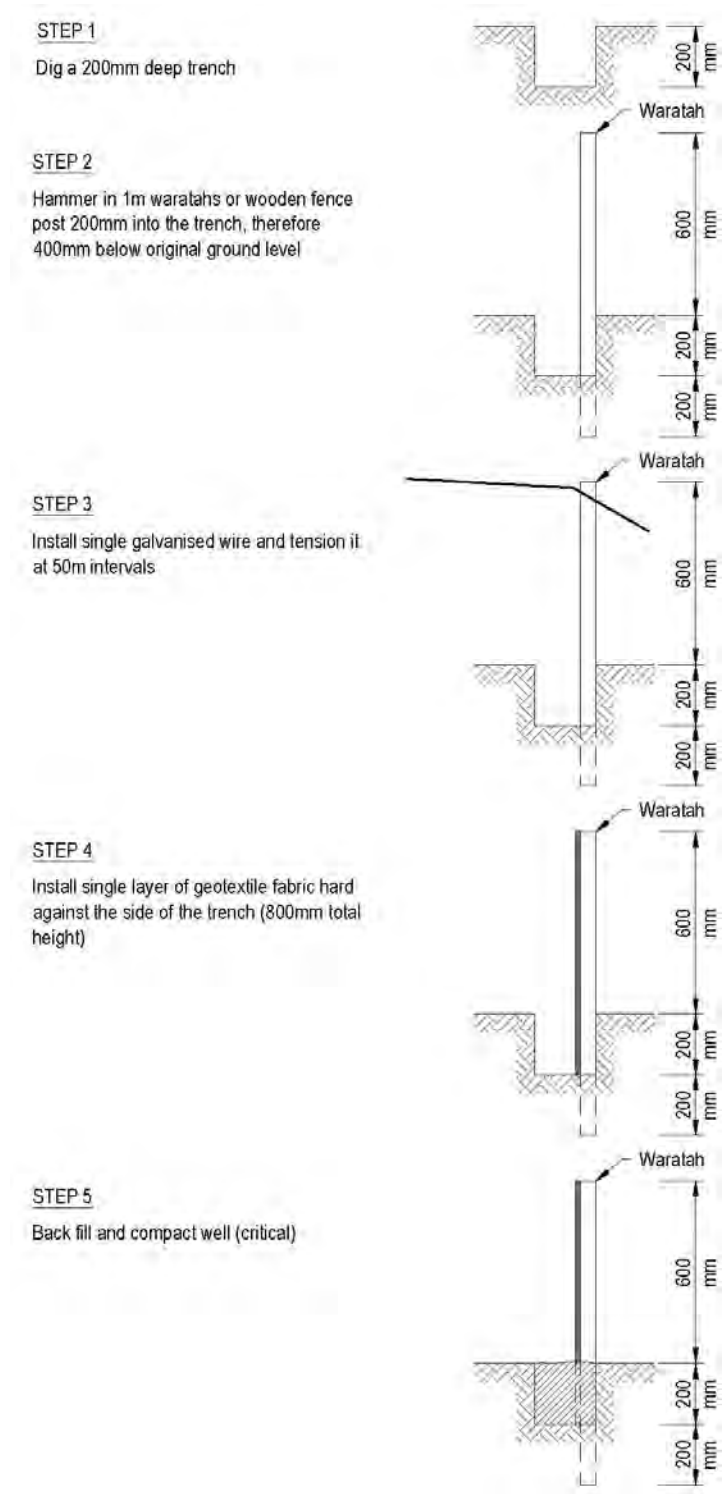

Figure 84: Step-by-step installation of a silt fence

- Use silt fence material appropriate to the site conditions and in accordance with the manufacturer's specifications
- Always install silt fences along the contour (refer Figure 85)
- Excavate a trench to a minimum practicable width (the narrower the better to avoid loosening of surrounding soils) and 200 mm deep along the proposed line of the silt fence
- Use waratahs at least 1.5 m in length
- Install the support waratahs on the down-slope edge of the trench and silt fence fabric on the up-slope side of the support waratahs to the full depth of the trench, then backfill the trench with compacted soil
- Install the waratahs so that they are as flat as possible against the silt fence. If the waratah edge is against the silt fence, it will rub and eventually rip against the waratah
- Use correct silt fence clips or silt fence pins (refer Figure 86) to secure the silt fence material to the top wire. Wire ties and staples rip the silt fence material when the weight of the impounded water pushes against the silt fence and are not to be used
- Reinforce the top of the silt fence fabric with a support made of high tensile 2.5 mm diameter galvanised wire. Tension the wire using permanent wire strainers attached to angled waratahs at the end of the silt fence
- Where ends of silt fence fabric come together, ensure they are overlapped, folded and stapled/ screwed to prevent sediment bypass.



Figure 85: Contours create the same effect as returns in this case



Figure 86: Use of silt fence clips

Maintenance

To maintain silt fences:

- Inspect silt fences at least once a week and after each rainfall
- Check for damage including rips, tears, bulges in the fabric, broken support wires, loose waratahs, overtopping, outflanking, undercutting, and leaking joints in fabric
- Make any necessary repairs as soon as identified
- As the geotextile material becomes clogged with sediments, this will result in increased duration of ponding. Therefore, careful cleaning of the silt fence geotextile with a light broom or brush may be appropriate
- Remove sediment when bulges occur or when sediment accumulation reaches 20% of the fabric height
- Remove sediment deposits as necessary (prior to 20% of fabric height) to continue to allow for adequate sediment storage and reduce pressure on the silt fence
- Dispose of sediment to a secure area to ensure that it does not discharge to the receiving environment.

F1.3.3 Decommissioning

When decommissioning a silt fence:

- Do not remove silt fence and accumulated sediment until the catchment area has been appropriately stabilised
- Remove and correctly dispose of accumulated sediment
- Backfill trench, re-grade and stabilise the disturbed area.

F1.4 Super silt fences

F1.4.1 Design

Definition

A super silt fence is a temporary barrier of woven geotextile fabric over a wire mesh fence that is used to capture predominantly coarse sediments carried in sheet flows (refer Figure 87 and Figure 88). Super silt fences temporarily impound sediment-laden runoff, reduce velocities and allow sediment to settle out of the water.

Purpose

The purpose of a super silt fence is to detain runoff flows so that deposition of transported sediment can occur through settlement.



Figure 87: Super silt fence

Conditions where practice applies

The use of super silt fences is similar to that of silt fences. However, super silt fences are more robust devices that are appropriate to control runoff from steeper or larger catchments than silt fences.

Super silt fences should be used:

- To intercept sheet flow
- To delineate the limit of disturbance on an earthworks site such as riparian areas or bush reserves
- To provide a barrier that can collect and hold debris and soil, preventing the material from entering critical areas, watercourses or streets
- Where the installation of an earth or topsoil bund would destroy sensitive areas such as bush and wetlands.

Super silt fences should be placed as close to the contour as possible. No section of the fence should exceed a grade of 5% for a distance of more than 15 m.

Do not install super silt fences across watercourses or in areas of concentrated flows.

Limitations

The following limitations apply to super silt fences:

- Super silt fences do not capture many soil particles finer than 0.02 mm in diameter (e.g. fine silts and clays) due to the short detention time of water behind the super silt fence and relatively large pore size of most fabrics
- Pores in the super silt fence fabric can become clogged relatively quickly with fine textured sediments, resulting in the fabric becoming impermeable

- They are only used for sheet flows, not concentrated flows. Do not use super silt fences as check dams in channels (to reduce velocities) or place them where they will intercept concentrated flows
- Super silt fences should be used a part of a treatment train approach.

Key design criteria

The following design criteria apply to super silt fences (also refer Figure 88):

- Ensure super silt fence height is 800 mm above ground level
- Maximum slope lengths, spacing of returns and maximum silt fence lengths are shown in Table 14
- Always install super silt fences along the contour (at a break in slope). Where this is not possible, or where there are long sections of super silt fence, install short silt fence returns projecting up-slope from the silt fence to minimise the concentration of flows. Silt fence returns should be a minimum 2 m in length and can incorporate a tie-back. They are generally constructed by continuing the silt fence around the return and doubling back, eliminating joins
- Join lengths of silt fence by doubling over fabric ends around a waratah or by stapling the fabric ends to a batten and butting the two battens together
- Install silt fence returns at either end of the silt fence, projecting up-slope to a sufficient height to prevent outflanking
- When considering super silt fence installation for larger catchments (greater than 0.5 ha) as in Table 14, carefully consider the specific site conditions and other alternative control measures available
- Base the length of the super silt fence on the limits shown in Table 14.

Table 14: Super silt fence design criteria

Slope steepness %	Slope length (m) (maximum)	Spacing of returns (m)	Super silt fence length (m) (maximum)
0 – 10%	Unlimited	60	Unlimited
10 – 20%	60	50	450
20 – 33%	30	40	300
33 – 50%	30	30	150
> 50%	15	20	75

- Where the ends of the geotextile fabric come together, overlap, fold and staple the fabric ends to prevent sediment bypass
- The geotextile fabric must meet the following requirements:
 - Wide width tensile strength = ≥ 14 kN/m minimum (AS, ASTM or ISO test methods allowed)
 - Retained strength at 500 h UV = 70% minimum (AS, ASTM or ISO test methods allowed)
 - Opening size (EOS) = 0.2-0.4 mm (AS, ASTM or ISO test methods allowed)

- Super silt fence wire mesh shall consist of a knotted or welded wire mesh. The knotting or welding process shall not leave any shape or protruding objects that may damage the super silt fence fabric when installed. The wire mesh must meet the following requirements:
 - Wire diameter = 1.5 mm minimum
 - Mesh aperture = 100 mm maximum
 - Mesh height = 1 m minimum
 - Coating = Galvanised or zinc coated.

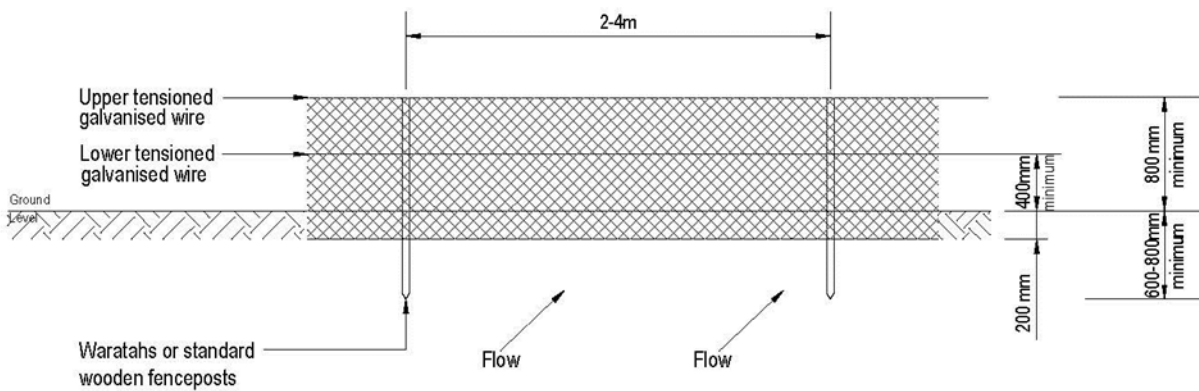

Elevation

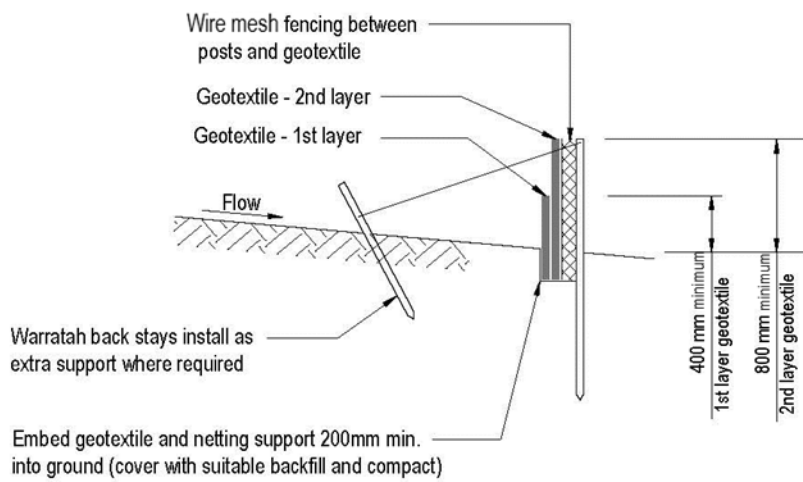

Cross-section

Figure 88: Schematic of a super silt fence

F1.4.2 Construction, operation and maintenance

Construction and operation

For construction and/or operation of super silt fences, follow the following key steps and refer to Figure 89:

- Use super silt fence material appropriate to the site conditions and in accordance with the manufacturer's specifications
- Always install super silt fences along the contour
- Excavate a trench a minimum of 100 mm wide and 200 mm deep along the proposed line of the super silt fence
- Use supporting waratahs at least 1.8 m in length
- Ensure the 1.8 m long waratahs are driven to an appropriate depth (0.8 m minimum)
- Install tensioned galvanised wire (2.5 mm HT) at 400 mm and again at 800 mm above ground.
- Tension the wire using permanent wire strainers attached to angled waratahs at the ends of the super silt fence
- Secure wire mesh fence to the waratahs with wire ties or staples, ensuring the wire mesh fence goes to the base of the trench
- Fasten the super silt fence material securely with ties spaced every 500 mm at the top and mid-section of the super silt fence. (Note: Most manufacturers now supply specific super silt fence geotextile with the two layers of geotextile already joined.)
- Place the super silt fence material into the base of the trench (a minimum of 200 mm into the ground) and place compacted backfill back to the original ground level
- When two sections of super silt fence material adjoin each other, ensure they are doubled over a minimum of 300 mm, wrapped around a waratah and fastened at 75 mm spacings to prevent sediment bypass.

STEP 1

Dig a 200mm deep trench



STEP 2

Hammer in 1.8m waratahs 800mm into the trench (therefore 1000mm below original ground level)

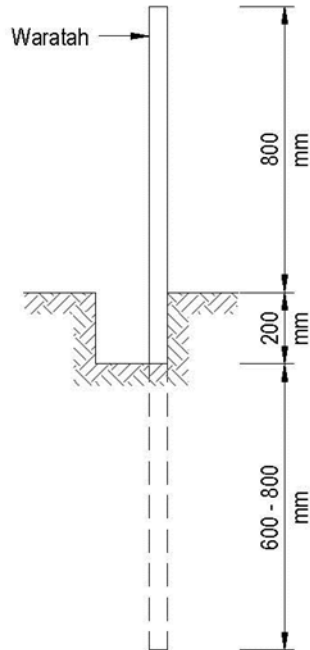

STEP 3

Install two rows galvanised wire and tension at 50m intervals

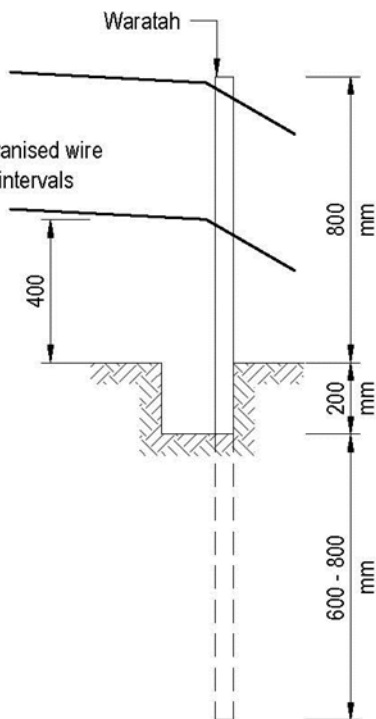

STEP 4

Install Wire mesh fencing and two layers of geotextile fabric - first layer is 600mm total height and second is 1000mm total height.

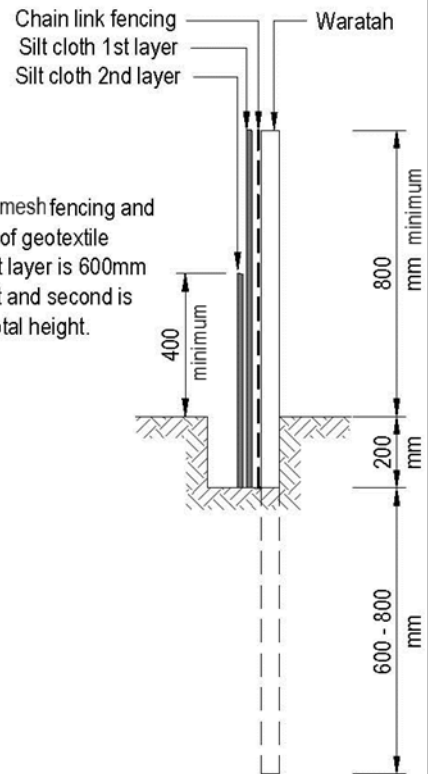

STEP 5

Back fill and compact well (critical)

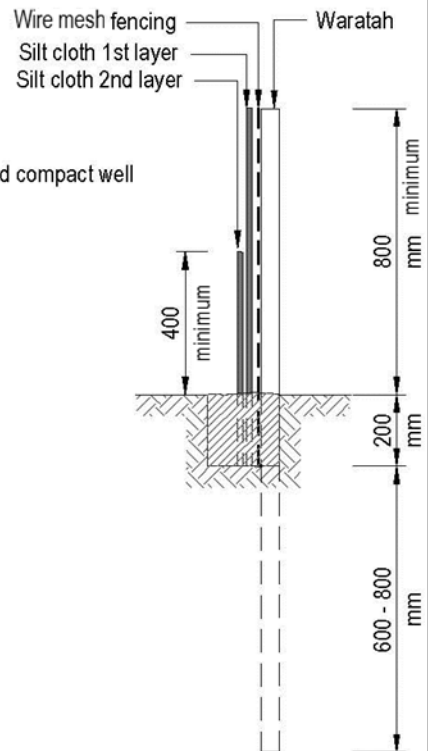

Figure 89: Step-by-step installation of a super silt fence

Maintenance

To maintain super silt fences:

- Inspect super silt fences at least once a week and after each rainfall
- Check for damage including rips, tears, bulges in the fabric, broken support wires, loose waratahs, overtopping, outflanking, undercutting, and leaking joints in the fabric
- Make any necessary repairs as soon as identified
- As the geotextile material becomes clogged with sediments, the duration of ponding increases. Therefore, careful cleaning of the super silt fence geotextile with a light broom or brush may be appropriate
- Remove sediment when bulges occur or when sediment accumulation reaches 20% of the fabric height
- Remove sediment deposits as necessary (prior to deposits reaching 20% of fabric height) to continue to allow for adequate sediment storage and reduce pressure on the super silt fence
- Dispose of sediment to a secure area to ensure it does not discharge to the receiving environment.

F1.4.3 Decommissioning

For decommissioning of super silt fences:

- Do not remove the super silt fence and accumulated sediment until the catchment area has been appropriately stabilised
- Remove and correctly dispose of accumulated sediment
- Backfill trench, re-grade and stabilise the disturbed area.

F1.5 Silt socks

F1.5.1 Design

Definition

Silt socks are a tubular stormwater sediment control and filtration device, consisting of a mesh tube filled with a filter material (e.g. compost, sawdust, wood bark, straw) used to intercept and filter runoff (refer Figure 90). They are also referred to as ‘filter socks’.

Purpose

Silt socks have a limited capacity to capture and treat sediment-laden flows and so are generally used for small, flat, isolated catchment areas (refer Table 15 and Table 16).

They temporarily impound sediment-laden runoff, slowing down the flow rate and allowing sediment to settle out of the water.

Silt socks can be used to:

- Intercept and impound sheetflow
- Intercept and impound runoff before it enters a catchpit or other stormwater inlet
- Reduce the velocity of runoff flows within a channel (as a check dam)
- Contain and impound discharges from pumped stormwater or concrete washwater (commonly referred to as a ‘turkeys nest’).

Silt socks can be used to divert flows and are commonly used for this purpose across haul roads when rain is forecast, or at the end of the day. They are also used as check structures in diversion drains and flow paths. These uses are not discussed in this section, which is restricted to the use of silt socks as a sediment management tool. For use of a silt sock device for catchpit protection refer to Section F1.6.

Conditions where practice applies

Silt socks should be used:

- On small, low gradient sites (e.g. short batter fills and around watercourses and vegetated or protected areas) (refer Table 15 and Table 16)
- As a secondary containment and treatment structure where it is not possible to divert flows to a sediment retention facility
- Where it is necessary to slow channel velocity
- Where concrete washwater or pumped stormwater is required to be treated prior to discharge.



Figure 90: Silt sock used to provide control during final landscaping

Limitations

The following limitations apply to silt socks:

- They can only to be used in very small catchments (refer Table 15 and Table 16)
- They have a low sediment storage capacity and therefore do not capture many fine soil particles (e.g. fine silts and clays) due to the short detention time of water behind the silt sock
- Over relatively short periods of time, the filter material can settle/compact, resulting in a reduction in both storage volume and filtration capacity. As such, silt socks are only appropriate as a short-term control
- As a sediment treatment device, they should only be used for sheet flows, not concentrated flows. Using a silt sock as a check dam in channels (to reduce velocities) or placing them where they will intercept concentrated flows, is a separate management approach (refer to check dams in Section E2.4)
- They are heavy, particularly when wet. Generally, they require an excavator to move them, which can result in damage to the silt sock
- They can be difficult to install with complete contact with the ground on coarse or uneven terrain
- They have high maintenance requirements (refer Section F1.5.2)
- They are susceptible to traffic damage.

Key design criteria

The following design criteria apply to silt socks:

Perimeter control

- Ensure that an appropriately sized silt sock is used (see design criteria in Table 15 and Table 16).

Table 15: 300 mm diameter silt sock

Slope steepness (%)	Maximum slope length (m)	Spacing of returns (m)
Flatter than 2%	100	N/A
2% - 10%	40	30
10% - 20%	30	25
20% - 33%	10	10
33% - 50%	5	10
>50%	2	5

Table 16: 450 mm diameter silt sock

Slope steepness (%)	Maximum slope length (m)	Spacing of returns (m)
Flatter than 2%	150	N/A
2% - 10%	60	30
10% - 20%	40	25
20% - 33%	20	10
33% - 50%	10	10
>50%	5	5

Compost specifications

- Ensure the compost medium used in the silt sock is free from contaminants and meets the specifications in Table 17.

Table 17: Specifications for compost

Parameter	Unit of measure	Specification
pH	pH units	5.0 - 8.0
Moisture content	% wet weight basis	>60
Organic matter content	% dry weight basis	25 - 100
Particle size	% passing a selected mesh size, dry weight basis	50 mm 99% passing; 10 mm 30 - 50% passing (or 50 - 70% retained); maximum 50 mm.

Bark specification

- Use 2-10 mm chip
- Ensure bark is free from contaminants.

Sawdust specification

- Do not use treated wood sawdust
- Ensure sawdust is free from contaminants.

Straw specification

- Ensure straw is free from weed seeds and contaminants.

General specifications for sock media

- The filter medium should be clean and free from contamination.

The material used to fill the sock will depend on the application. For example, if the sock is to be used as a filter, a porous material such as rocks or wood bark will not be effective.

F1.5.2 Construction, operation and maintenance

Construction and operation

Silt socks can either be filled on site or prefabricated in suitable lengths prior to delivery to the site. The silt sock should be produced from HDPE or polyester material with abrasion resistant netting weaves (a thread diameter of not less than 0.3 mm). The recommended weave for a compost sock (refer Figure 91) is an opening in the knitted mesh of 1-5 mm when filled. The weave for straw socks should have openings of no more than 20 mm. The silt sock shall then be filled with compacted filter material meeting the specifications detailed above.

Silt socks using a light filter medium such as straw or wood chips must be tied down using stakes and twine to prevent 'floating'.

Note: The above requirement to secure silt socks with a light filter medium will generally preclude their use on impervious surfaces such as concrete or seal.

For construction and/or operation of silt socks:

- Always install silt socks on the contour. Where this is not possible, or where there are long sections of silt sock, install short silt sock returns, projecting up-slope from the silt sock to minimise concentration of flows. Returns are to be a minimum of 2 m in length
- Where more than one length of silt sock is used, the silt socks are to be overlapped a minimum of 1 m (refer Figure 92) or, according to the manufacturer's recommendation, and joined by a sleeve (refer Figure 93)
- Install silt sock "wings" at either end of the silt sock, projecting a sufficient length up-slope to prevent outflanking
- Silt socks are to be pegged and secured depending on the application.

For additional security, bale twine may be used as shown in Figure 94. The bale twine is secured (four turns with a half hitch) to the pine stakes and tensioned when the stakes are driven into place.



Figure 91: Compost silt socks with returns installed



Figure 92: Silt sock with 1 m overlapping joint



Figure 93: Silt sock joined using a sleeve and pegged and secured using baling twine with 1 m overlapping joint



Figure 94: Straw sock secured in place using stakes and bale twine; note the stakes are placed every 600 mm

When using silt socks to construct turkeys' nests (refer Figure 95):

- Set up a ring of silt socks, with the proposed pumping discharge point in the centre of the ring
- Ensure that treated discharge from the “turkeys nest” will not result in erosion or the remobilisation of sediment
- The size of the ring will depend on the flows that are to be pumped. The flow and size of the ring will need to be such that the ring is not overtopped
- A base-laid permeable geotextile may be used to collect settled debris.



Figure 95: ‘Turkeys nest’

Maintenance

Consider the following when maintaining silt socks:

- Silt socks should be inspected regularly and after each rainfall event to ensure sediment control efficiency is maintained
- Accumulated sediment greater than 20% of the height of the silt sock should be removed, or another silt sock placed on top of the existing silt sock to maintain adequate sediment control
- Reuse of silt socks is possible provided the integrity of the sock and fill media is maintained.

F1.5.3 Decommissioning

Consider the following when decommissioning (removing) silt socks:

- Do not remove the silt sock and accumulated sediment until the catchment area has been appropriately stabilised (refer Figure 96)
- Remove and dispose of accumulated sediment.



Figure 96: Silt sock used to provide control during final landscaping works

F1.6 Stormwater inlet protection

F1.6.1 Design

Definition

Stormwater inlet protection is a barrier across or around a catchpit, a water sensitive design (WSD) device (e.g. rain garden) or other stormwater inlet. The protection may take various forms depending upon the type of inlet to be protected (refer Figure 97).

Purpose

This practice is used to intercept and filter sediment-laden runoff before it enters a reticulated stormwater system, via a catchpit, scruffy dome, manhole or WSD device. This reduces discharge of sediment-laden flows into receiving environments or into a permanent sediment control system during construction.



Figure 97: Stormwater inlet protection silt fence within a construction yard

(Note: Flooding not an issue in this case)

Conditions where practice applies

Stormwater inlet protection is a secondary sediment control device and must not be used as a standalone device. It must only be used in conjunction with other ESC measures, as part of a broader and more comprehensive ESC system.

Limitations

Stormwater inlet protection has the following limitations:

- It should not be used as a standalone treatment device
- It should not be used in concentrated flows such as at the inlet to a culvert
- It can have relatively low sediment removal efficiency and low sediment storage capacity
- It has high maintenance requirements (refer Section F1.6.2)
- There is potential for blockage of the device and therefore, increased risk of inundation
- The device can cause flooding to road carriageways due to its limited hydraulic capacity. Flooding can lead to public safety issues
- The device is easily damaged by vehicles and construction equipment.

Key design criteria

The following design criteria apply to stormwater inlet protection devices:

- Complete blocking of the stormwater system must be avoided, as this will divert flows during heavy rain and may cause other devices to become overwhelmed and/or create flooding hazards
- The height of catchpit protection within live road environments must be less than the kerb height so that runoff does not cause local flooding and/or direct flows to other nearby catchments.

Silt fence

A silt fence (refer Section F1.3) can be erected around the inlet. This method is appropriate where catchpits have been connected to a stormwater system and are collecting runoff from disturbed soil surfaces within a construction site, where the retention of water will not create a flooding hazard (refer Figure 98). This is not appropriate for road maintenance or upgrade works within a 'live' roading situation where impounded water will create flooding issues.



Figure 98: Good use of a silt fence installed to protect a new stormwater catchpit where impounded water will not create a flooding hazard

Check dams

A series of low sandbag check dams can be installed up the gutter from the catchpit to act as a series of small sediment traps (refer Section E2.4). Check dams require a spillway lower than the kerb to ensure that runoff does not encroach onto the berm area and cause scouring. They should comprise up to six sandbags laid end to end, with no gaps, in an arc away from the kerb and up the road to create a series of impoundment areas.

This measure is only suitable for very small catchment areas.

Check dams can also be constructed from silt socks (refer below), which will also provide a minor degree of filtration.

Silt socks

A silt sock (refer Section F1.5) can be placed around the inlet to act as a small sediment trap immediately up-slope of the catchpit (refer Figure 99). The silt sock needs to completely 'ring fence' the catchpit.

This measure is only suitable for very small catchment areas.



Figure 99: Installation of a silt sock to provide some protection to the catchpit

F1.6.2 Construction, operation and maintenance requirements

Construction and operation

Consider the following when constructing and/or operating stormwater inlet protection devices:

- Construction specifications will vary according to the type of inlet protection
- Always ensure an emergency bypass is included
- Plan for where the bypass system will divert water
- Ensure the device does not allow water to bypass its intended flow path
- Keep all stockpiles and loose sediment away from roadside table drains.

Maintenance

Consider the following when maintaining stormwater inlet protection measures:

- Maintenance will vary according to the type of inlet protection
- Inspect daily and during and after rainfall events
- Beware of blockages and leaks that may affect performance
- Check to see if flows have been diverted away from the device and what, if any, damage has been caused
- Clean all accumulated sediments immediately
- Repair and modify any problems immediately
- Remove devices as soon as works are complete.

F1.6.3 Decommissioning

Consider the following when decommissioning stormwater inlet protection measures:

- Devices **must be** decommissioned and removed after use
- Decommissioning will vary according to the type of inlet protection
- Remove and dispose of any accumulated sediments
- Remove control measures, then reuse and recycle components
- Stabilise any disturbed areas.

F2.0 Coagulant and flocculant treatment

F2.1 General

Note: This section outlines some guidance on the application of flocculants and coagulants (reagents) for the purposes of ESC. It is intended to supplement information in Auckland Regional Council's Technical Publication TP227 (2004)².

F2.1.1 Definition

This treatment comprises the addition of reagents to sediment-laden runoff to increase the rate of settlement of fine soil particles. The treatment relies on two basic processes: coagulation and flocculation. A number of reagents are available; preference should be given to those which have a minimal impact on the receiving environment.

F2.1.2 Purpose

Flocculation and/or coagulation can be used to improve the efficiency of sediment retention devices. The physical and chemical nature of suspended clay particles means they settle very slowly. By adding certain reagents to the suspension, these particles join together to form larger particles and settle much more rapidly; thereby increasing the effectiveness and efficiency of the sediment retention device.

The reagent used, and the method of its use, is dependent on the soils onsite and the design of the sediment retention device.

F2.1.3 Coagulation

Coagulation will be most effective with soils that have a high proportion of fine colloidal particles. These particles typically have a negative electrostatic surface charge. These 'like charged' particles tend to repel each other, preventing coagulated particles from forming, such that the particles remain in suspension.

By adding a reagent that develops positive charges the colloidal material is destabilised, allowing the particles to clump together (coagulate) forming larger heavier particles.

F2.1.4 Flocculation

In the process of flocculation, the particles join together following the addition of the reagent to form 'flocs', which join together forming larger, heavier particles that settle more rapidly.

² TP227 *The Use of Flocculants and Coagulants to Aid the Settlement of Suspended Sediment in Earthworks Runoff: Trials, Methodology and Design*, June 2004.

F2.1.5 Conditions where practice applies

This type of treatment will be effective for the majority of soils in the Auckland region, particularly in sediment retention ponds. To determine the likely effectiveness of treatment, a 'bench test' should be undertaken. The bench test will provide information on which reagents are most effective and the optimal dosage rate at which they should be applied. A bench test involves collecting a sample of the earthworks site's soil, mixing it with water in a clear cylinder and measuring the time the suspended sediment takes to settle (Appendix F).

Treatment for a sediment retention pond (SRP) should typically always be provided. In addition, decanting earth bunds (DEBs, refer to Section F1.2) can benefit from treatment.

F2.1.6 Limitations

The following limitations apply to treatment:

- pH must be tested as part of the bench testing methodology and should be used as a control baseline. Whatever flocculant is being used must not change that baseline from a pH beyond +/-1 and must not fall outside of the range of 5.5 – 8.5, as measured from the primary spillway
- Treatment should cease when the above pH limits cannot be met (when using PAC)
- Treatment requires a high degree of monitoring and maintenance (refer Section F2.2)
- Spills of reagents can have significant adverse effects on the receiving environment
- In significant rainfall events (>15 mm in 24 hours), the rate of use needs to be carefully monitored so that the system does not run out of reagent.

Due to the above limitations, treatment should only be implemented under the supervision of a suitably experienced and qualified professional.

F2.1.7 Treatment options

There are a number of treatment options in relation to both reagent type and the nature of dosing. Selection of the appropriate reagent will be subject to the soils on site, sediment control measures used and the receiving environment. Mana whenua values should be considered in the choice with consideration given to organic alternatives where practicable. In all cases, bench testing of a variety of reagents is required to establish which option is most appropriate for sediment removal and receiving environment protection.

The majority of experience and research in the Auckland region to date relates to the use of poly aluminium chloride (PAC). The guidance in the following sections therefore uses PAC as an example, as it is the best understood reagent at present. However, PAC may not be the most effective reagent in all situations due to site and sub-regional variances in soils or receiving environments. This is why bench testing of alternatives is crucial. Ongoing research into the use of other reagents is encouraged, and this guidance may be updated as understanding of the use and effects of other reagents develops.

The majority of flocculants are typically available in a liquid or a solid (granulated) form, allowing dosing by either a rainfall activated system, a geosynthetic sock (floc sock) or batch dosing (refer to design details for each below). If a floc sock is to be used, the dose rate, and type, of chemical needs to be confirmed and designed appropriately.

Specific details of alternative reagents and dosing procedures proposed for each site should be included in the Flocculation Management Plan (also often referred to as a Chemical Treatment Management Plan). The following sections detail the main forms of treatment and dosing:

- Rainfall activated treatment (also called rainfall activated dosing (refer Figure 100))
- Batch treatment (also called batch dosing).

Safety

The Material Safety Data Sheet for each reagent used in the treatment system should be obtained and the health and safety requirements reviewed and implemented at all times. Bulk storage of the reagent should be in accordance with standard practice for storage of hazardous materials on site. Specifically, the reagent should be stored in a secure bunded facility.

The bunded area should either be covered to avoid rain collecting in the bunded area, or a regular maintenance programme should be implemented to drain rainfall that is collected, maximising the capacity of the bunded area for containing spills.

Storage of the reagent at each pond site should be within the locked shed. A small number of unopened drums of reagent may be stored adjacent to the shed (for use as needed), particularly over winter. These drums should be located and stored in a manner that minimises the risk of a spill from the drums.

The transportation of reagent to and from the project should be undertaken in accordance with the required hazardous goods, traffic and transport regulations.

On site, the reagents should be transported in sealed containers, securely retained within the vehicle. These containers should be small enough to be easily handled, with only the required volume being transported.

The use of these reagents should be in accordance with the site Health and Safety Management Plan.



Figure 100: Rainfall activated flocculant treatment device

F2.2 Rainfall activated treatment

Rainfall activated treatment is the preferred option for treatment of sediment-laden runoff as it provides an appropriate level of dosage of reagent based on the rainfall volume and intensity.

A rainfall activated system is appropriate for most liquid reagents. The following guidance outlines best practice for the design, installation, operation and maintenance of a rainfall activated system, and provides specific details for the use of PAC as an example reagent. Alternative reagents may also be used, and the specifics of that reagent will need to be taken into consideration during the design of the system and specified in the Flocculation Management Plan. The specifics that need to be considered are:

- The required dose rate, as determined by bench testing
- The specific gravity of the reagent in the form to be used. Many reagents will require a degree of dilution to be suitable for this system.

The device operates as follows (refer Figure 101):

- Rainfall is collected in the catchment tray and discharged to the header tank
- The header tank is designed to rise and sink in the reagent tank, depending on the amount of rain it holds. This automatically adjusts the amount of reagent entering the sediment retention pond (or decanting bund). Orifice locations also ensure reagent isn't discharged unnecessarily. The header tank provides:
 - Zero reagent discharge until a pre-selected quantity of rain has fallen
 - A slow start to the dosing rate to allow runoff flowing off the site at the beginning of a storm to accumulate
 - An extension of the dosing period to provide treatment of runoff that occurs following cessation of rainfall.
- From the header tank, the rainwater discharges (by gravity) through low and high flow outlets into the displacement tank, which floats in the flocculant reservoir tank (which has been filled with the pre-selected reagent). As the displacement tank fills with rainwater, reagent is displaced through the outlet in the flocculant reservoir tank and then flows by gravity to the dosing point.

F2.2.1 Design

Conditions where practice applies

Treatment using a rainfall activated system is best used when using liquid reagents where any of the following apply:

- The duration of treatment is long (more than 4 weeks)
- The catchment area is greater than 0.5 ha
- Earthworks are during periods of increased rainfall (e.g. winter)
- The site is unattended for more than 24 hours.

Key design criteria

General

The main components of the rainfall activated flocculant treatment device are (refer Figure 101):

- Rainfall catchment tray
- Header tank
- Displacement tank
- Flocculant reservoir tank.

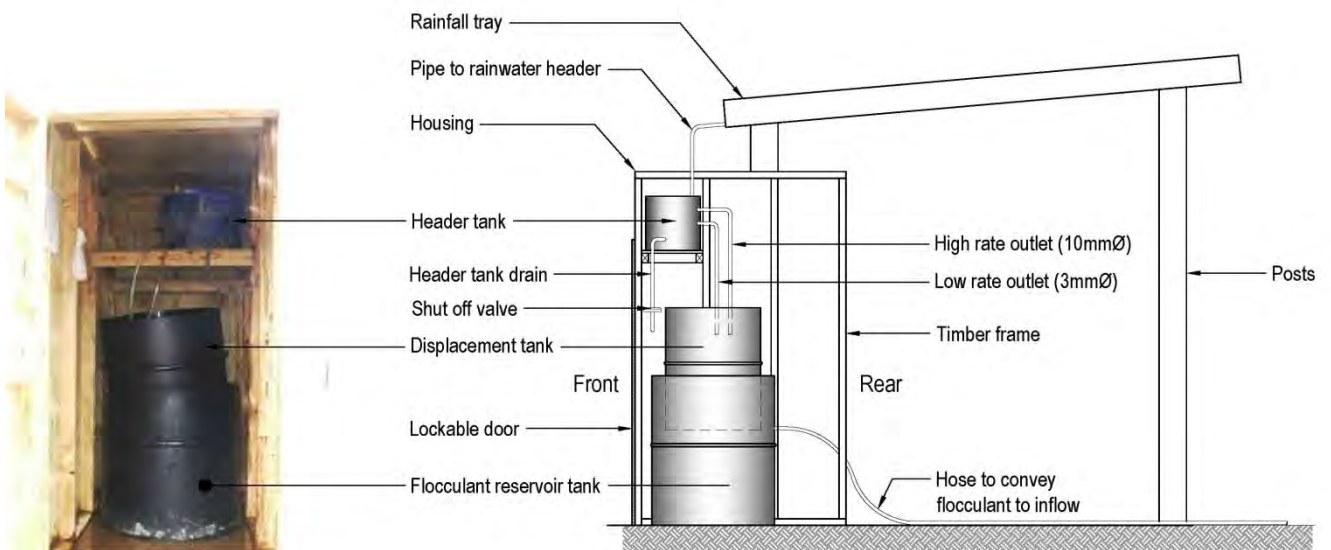

Figure 101: Rainfall activated treatment system

Laboratory tests need to be undertaken using sediment-laden runoff from the site, and the optimal dose of reagent determined.

Reagent discharge should be to the turbulent section of the inlet drain, to ensure the reagent mixes thoroughly with the dirty water.

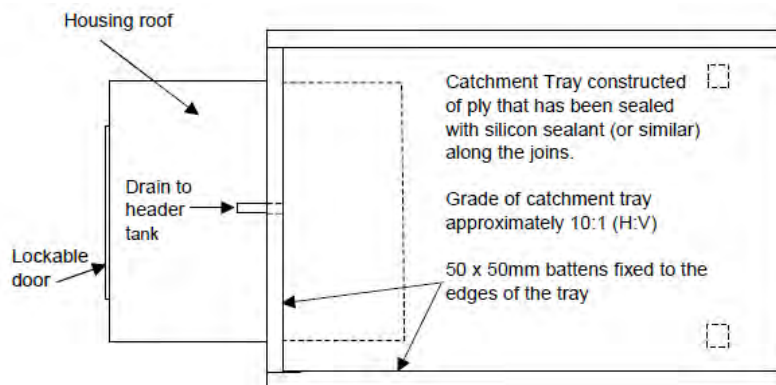

Figure 102: Rainfall catchment tray

Rainfall catchment tray

- The catchment tray area (refer to Figure 102) will increase as the dosage rate or contributing catchment increases
- The rainfall catchment tray area will decrease as the dosage rate or contributing catchment area decreases

The size of the rainfall catchment tray is determined by the size of the catchment draining to the sediment retention pond. The tray is sized to provide flocculant treatment for 100% of the runoff from the exposed earthworks areas, and 60% of the runoff from the stabilised contributing catchment area. The design of the tray is set out in Figure 102.

Header tank

- The zero-reagent discharge rainfall volume can be adjusted manually for site characteristics by adding or removing water from the header tank (refer Figure 103)
- The header tank requires a drain hose as low as practical to allow the header tank to be fully emptied and or to adjust the zero-discharge volume. This drain should include a valve for ease of use
- Low-rate and high-rate outlets need to be installed
- The low-rate outlet consists of an outlet hose with a 3 mm orifice. The standard header tank design allows for 12 mm of rainfall before dosing commences
- The high-rate outlet consists of an outlet hose with a 10 mm orifice. The high-rate outlet invert should be positioned at that point reached by a further 12 mm of rainfall
- The slow start/attenuation characteristics can be regulated for site characteristics, if necessary, by providing more than one low-rate outlet and at different levels from the header tank
- The header tank should have a minimum freeboard of 50 mm above the top of the high-rate outlet pipe.



Figure 103: Header tank

Displacement tank

- The displacement tank needs to be a neat fit inside the flocculant reservoir tank. However, it should not be so snug that it can jam or prevent additional flocculant from being added
- The displacement tank should have capacity to hold runoff from the 50% AEP event.

Flocculant reservoir tank

- The flocculant reservoir tank needs to be only slightly larger than the displacement tank. The larger the reservoir and displacement tanks, the less servicing required
- The flocculant reservoir tank requires sufficient capacity, set by the height of the outlet hose, to provide for the dosing of reagent into a runoff volume equivalent to the 50% AEP rainfall event
- A 20 mm (minimum) diameter outlet hose needs to be installed in the side of the tank to drain through the side of the shed (refer Figure 104) to the pond inlet channel
- The dosing point of the outlet into the sediment-laden diversion should be at least 5 m upstream of the forebay to promote mixing of the reagent.



Figure 104: Flocculation shed

F2.2.2 Construction, operation and maintenance

Treatment should only be implemented under supervision of a suitably experienced and qualified professional.

The following provides guidance on the installation, operation and maintenance of treatment systems. Specific details are also provided for the use of PAC as this is currently the most well-documented reagent within the Auckland region. Alternative reagents are also acceptable, provided the specifics of that reagent are taken into consideration during the construction of the system and are specified in the management plan.

Construction (installation)

For construction of a rainfall activated treatment system:

- The shed can be constructed of a number of materials. Timber framed plywood is the typical construction material
- Ensure that the shed is large enough to accommodate the various tanks without restricting their operation
- Ensure the shed is of durable construction. Consider lifting points or skids to allow for easy relocation
- Ensure that the shed, particularly the rainfall catchment tray, is well secured to the ground to prevent wind damage
- Ensure the shed has a lockable door for security and public safety
- Locate the shed in a location that allows servicing and maintenance in all weather conditions.

Operation and maintenance

For operation and/or maintenance of a rainfall activated treatment system:

- Maintenance requirements need to be assessed before and following every rainfall event, or during rainfall events if exceptionally heavy and/or prolonged rainfall occurs
- Before the site is left unattended for weekends or other periods, the treatment system should be serviced by the responsible site staff member so that the maximum amount of runoff can be treated by the dosing system
- The system may require some on-going adjustment to suit the site characteristics and runoff (as explained further below).

Header tank

- The header tank is used to delay dosing during the initial stages of rainfall when site conditions are dry, and no runoff is expected. The header tank also regulates the discharge of reagent to mimic surface runoff, specifically by allowing a higher outfall during heavy rainfall and by increasing the duration of discharge beyond the end of rainfall
- The volume in the header tank is lowered using the lowest of the three outlet tubes:
 - After 3 days without rain - reduce volume to 50%
 - After 6 days without rain - reduce volume to empty (level at lowest outlet)
- In wet weather, or if the site is generally wet, water may be added manually to the header tank to cut down the response time so that the system responds more rapidly after rain commences
- If the system is to be operated over the winter period, then the system should also be set to 'no delay'
- Adjusting the water level within the header tank can be used to regulate under- or over-dosing of the pond. Under-dosing may lead to discharge of higher levels of suspended sediment from the pond. Whereas over-dosing of PAC may cause a reduction in pH, raising potential for aluminium within the PAC to react, forming toxic aluminium compounds that are bioavailable to fresh and marine water organisms. Adjusting the water level within the header tank should only be an interim measure until further bench testing and/or tray sizing takes place.

Refilling the flocculant reservoir

- When the volume of reagent in the reservoir tank is reduced such that there is insufficient reagent to dose a major storm, the displacement tank should be emptied, and the flocculant reservoir refilled
- The displacement tank may either be emptied using a siphon, bailed out by hand or pumped. The method of emptying this tank should be considered in the design of the shed
- The flocculant reservoir is best filled using a drum pump, to pump from a 200 L drum.

Monitoring and adjusting for changing site conditions

- Each new treatment system needs to be carefully monitored during the first few rainfall events to check that the system is effective, and to check that no over- or under-dosing is occurring
- Changes in catchment areas and/or soils will also require a review of the treatment system design. Minor changes can typically be accommodated through modification of the rainfall catchment tray. More significant changes will also require a modification of the header tank
- If over-dosing is suspected, because the pond dead-storage water is exceptionally clear, samples must be taken from the pond for pH and residual chemical analysis. The dosing regimen should be adjusted depending on the outcome of these results
- If over-dosing occurs, or if it is clear that the quality of stormwater runoff is improving because of stabilisation of the site, the reagent dose must be reduced by reducing the size of the catchment tray. This can be done by placing and sealing a board (batten) diagonally across the tray with a hole through the tray rim at the lower corner, so that water from the tray area above the batten discharges to waste. Alternatively, a suitably sized piece of plywood can be placed over the lower section of the tray to reduce the tray area
- Debris (such as leaves) should also be removed from the catchment tray to ensure that rainwater enters the header tank. The low- and high-rate hoses need to be checked regularly for blockages. In addition, all hose fittings need to be inspected regularly to identify any leakages
- Issues such as poor treatment performance, or consistently very clear treated water, should be dealt with by consulting a suitably experienced and qualified professional for advice on an appropriate action.

Spill management

- If there is a reagent spill onto the ground, it should be immediately contained using earth bunds to prevent it entering water. When using PAC, any spilt reagent should be recovered if possible and placed in polyethylene containers. If the spilt PAC cannot be recovered, it should be mixed with a volume of soil equal to at least ten times the volume of spilt PAC. This will effectively neutralise the PAC. The soil with which the PAC has been mixed should be buried a minimum of 0.5 m below the surface
- If there is a reagent spill into ponded water, discharge from the pond to natural water should be prevented. The ponded water should then be sampled and tested to confirm if the water is safe to discharge. (e.g. in the case of PAC, the pH and or free aluminium concentration should be checked to make sure it is within acceptable limits.)
- If there is a spill of reagent into flowing water:
 - Advise Auckland Council immediately
 - Record the volume of the spill
 - If possible, pump the water and spilt reagent into a bund or pond until all the spilt reagent has been removed from the watercourse
 - If the reagent cannot be removed from the watercourse, identify and advise any downstream users.

F2.3 Batch dosing treatment

Batch dosing is largely undertaken as a reactive measure to treat impounded runoff that has not been treated to the correct standard. Batch dosing is achieved by adding liquid reagent to the surface of impounded runoff to increase the rate of settlement to achieve the required standard of discharge.

Batch dosing may be undertaken as contingency measure in devices that have been treated by a rainfall activated system. Each soil type requires bench testing to determine correct dose rates (Appendix F).

Batch dosing can be utilised during dewatering processes (see Section G4.2.1). It is not an appropriate treatment measure during rainfall.

F2.3.1 Design

Conditions where practice applies

Batch dosing is appropriate where:

- Impounded runoff has not been treated to the correct standard, or
- Sediment-laden water has been collected by pumping, or
- Impounded sediment-laden water requires pumping.

Limitations

Batch dosing is only suitable for collected runoff. It is not practical to batch dose during rainfall.

Key design criteria

Batch dosing is undertaken to impounded runoff using a liquid reagent. The dosage rate is determined by bench testing.

The outflow from the device should be stopped until the treatment has achieved an appropriate level of control.

F2.3.2 Construction, operation and maintenance

Construction (implementation)

Treatment should only be implemented under the supervision of a suitably experienced and qualified professional.

For construction (implementation) of batch dosing:

- Raise the T-bar and block the outlet from the device prior to dosing
- Determine the volume of the impounded runoff. From the bench testing, determine the volume of reactant needed
- Add the reactant by spraying it on the surface of the device or by careful application using a bucket or other small container to evenly disperse the reactant over the surface of the device.

- The impounded water will then be mixed with the reactant using one of the following methods:
 - Mixing with a pole, paddle or oar
 - Mixing by circulating the impounded flows through a pump
 - Mixing by dragging semi-submerged floats through the surface area of the impounded water.
- Once settlement has occurred (typically 2-3 hours), check the pH and clarity within the device. If the pH is between the range of 5.5 and 8.5 and the clarity is greater than 100 mm, open the decant and drain the device
- If the clarity is less than 100 mm, add a further dose of reagent at 50% of the original rate and allow a further settlement period of 2-3 hours allowed before retesting
- If the pH levels fall +/-1 from natural levels, seek advice from a suitably experienced and qualified professional to determine appropriate actions. This could include offsite removal of impounded water or adding alternate substances, such as sodium carbonate or sodium bi-sulphate, to alter the pH. Subject to the weather conditions at the time, and the level by which the range has been exceeded, it may be appropriate to use the impounded water for dust control.

F2.4 Decommissioning

Decommissioning of a treatment system requires removal of any remaining reagent. This should be salvaged for reuse where practical but should not be mixed with 'fresh' reagent to minimise the potential for contamination of the fresh reagent.

All accumulated sediment must be removed and correctly disposed of.

The shed and tanks should be removed from the site and stored for reuse. (Note: The reuse of the treatment system will require some degree of modification to suit the specific details of the new site.)



G

Specific activities

Table of Contents

G1.0	Dewatering	144
G1.1	Unique nature of this activity	144
	G1.1.1 Conditions where practice applies	144
	G1.1.2 Limitations.....	144
G1.2	Best practice ESC for this activity	144
	G1.2.1 Key design criteria	144
	G1.2.2 Construction and operation	145
G2.0	Small sites	147
G3.0	Roads and utilities	148
G3.1	Roads	148
	G3.1.1 Unique nature of roading works.....	148
	G3.1.2 Best practice ESC for roading works.....	148
G3.2	Utilities	150
	G3.2.1 Unique nature of utility works	150
	G3.2.2 Best practice ESC for utility works.....	151
G4.0	Works within a watercourse	153
G4.1	Unique nature of this activity	153
G4.2	Best practice ESC for works in a watercourse	153
	G4.2.1 Temporary watercourse crossings	154
	G4.2.2 Dam and pump or dam and divert devices.....	156
	G4.2.3 Temporary watercourse diversions	157
G5.0	Winter earthworks	160
G5.1	Planning and management of winter works	160
G5.2	Applying for winter works approval	160
G6.0	Quarrying	163
G6.1	Unique nature of this activity	163
G6.2	Best practice ESC for this activity	163
	G6.2.1 Quarry access.....	163
	G6.2.2 Managing clean and dirty water.....	164
	G6.2.3 Overburden removal and disposal.....	164
	G6.2.4 Quarry product handling and stockpiling	164
G7.0	Agriculture (farm tracking)	165

G8.0	Soil binders	166
G8.1	Unique nature of this activity	166
G8.2	Best practice ESC for this activity	167
	G8.2.1 Design.....	167
	G8.2.2 Construction, operation and maintenance.....	167
G9.0	Dust control	169
G9.1	Unique nature of this activity	169
G9.2	Best practice ESC for this activity	169
	G9.2.1 Design.....	169
	G9.2.2 Construction, operation and maintenance.....	171

Figures

Figure 105:	Dewatering skip bin	145
Figure 106:	Dewatering bag and pipe sock.....	145
Figure 107:	Example of a mobile ‘turkeys nest’ used for dewatering.....	145
Figure 108:	Silt fence.....	147
Figure 109:	Progressive stabilisation in limited space.....	149
Figure 110:	Use of stabilisation products and progressive stabilisation.....	149
Figure 111:	Typical trenching methodology.....	152
Figure 112:	Temporary stream diversion to allow for the installation of a new culvert	153
Figure 113:	Stabilised clean water diversion and temporary culvert to divert streamflows while a new culvert is being constructed	154
Figure 114:	A temporary bridge in the process of being installed	154
Figure 115:	In the process of constructing a temporary crossing	155
Figure 116:	Water being diverted past a construction works area	156
Figure 117:	Commencement of over pumping to allow for in-stream works	156
Figure 118:	Examples of temporary stream diversion installed to allow permanent culverts to be installed off-line.....	157
Figure 119:	Diversion channel prior to plug removal.....	158
Figure 120:	Dewatering construction area into a sediment pond.....	158
Figure 121:	Opening up bypass channel and closing off existing one	158
Figure 122:	Re-establishment of flow in original channel.....	158
Figure 123:	Sandbag coffer dam installed to complete stormwater outfall	159
Figure 124:	Decanting earth bund and diversion bund installed during a farm track construction	165
Figure 125:	Forward planning and management to minimise dust provide the best options for control.....	169

SECTION G – SPECIFIC ACTIVITIES

Figure 126: Dust suppression using a water cart169

Figure 127: Snow blowing machine to provide dust control during a liming operation170

Figure 128: Dust suppression using soil binders/polymers170

Figure 129: Water truck dampening down the works area.....171

Figure 130: Regular wetting of the haul road171

Preface

This section outlines a number of construction activities where ESC measures need to be integrated into the works or activity. Each activity includes discussion on:

- The unique nature of the activity and the associated ESC issues
- Best practice ESC for the activity.



G1.0 Dewatering

G1.1 Unique nature of this activity

Dewatering is the removal of water from excavations, tunnelling, trenches and sediment control devices. It may be the removal of either surface water or groundwater and is generally undertaken by pumping. This process can generate fine textured material that is difficult to treat and retain on site, even through use of robust sediment control devices such as those described in this guideline.

G1.1.1 Conditions where practice applies

Dewatering devices apply:

- To dewater trenches, excavations and low-lying areas
- To dewater sediment control devices for maintenance, or at the decommissioning stage.

G1.1.2 Limitations

Dewatering has the following limitations:

- Care must be taken when pumping, as it produces fine textured sediment that can have adverse environmental effects
- Always try to minimise the volume of water that requires dewatering. This can be achieved by measures such as limiting the length of the open trench or providing diversions above excavations.

G1.2 Best practice ESC for this activity

G1.2.1 Key design criteria

When dewatering, consideration must be given to the following criteria:

- Minimise the volume of water and levels of sediment
- Retain sediment-laden water on site to maximise the settling of sediment on site (settling may be aided by the addition of flocculant treatment)
- Always dewater the cleaner water at the top first, and then pump the residual sediment-laden water to a sediment retention device, tank or truck. This water can be used as a dust suppressant or to aid compaction
- As a minimum, 100 mm clarity is required to allow water to be discharged offsite

- Small volumes of sediment-laden water can be pumped to a silt fence or decanting earth bund; however, care needs to be taken to ensure that these devices are not overwhelmed
- Larger volumes can be pumped to a sediment retention pond. Always pump to the forebay. Subject to the volumes pumped, the outlet may need to be blocked during pumping and the pond treated following pumping.

There are a variety of options for dewatering, including settling tanks/skip bins (refer Figure 105); dewatering bags (refer Figure 106); and turkey nests (refer Figure 107).



Figure 105: Dewatering skip bin



Figure 106: Dewatering bag and pipe sock



Figure 107: Example of a mobile 'turkey nest' used for dewatering

G1.2.2 Construction and operation

The following should be considered when constructing and/or operating dewatering devices:

- Plan for dewatering well before it is needed; the majority of excavation works will require some degree of dewatering
- Plan and organise works and construction to minimise dewatering volumes; e.g. by limiting the extent of trenching to that which can be worked and backfilled each day
- Recycle the water wherever possible (e.g. for dust suppression or earthworks conditioning)
- Pump from the top using a float, or similar, to keep the intake off the bottom of the excavation (the area to be dewatered). This will remove cleaner water while avoiding mobilisation of bottom sediments

- A minimum of 100 mm water clarity is required to pump directly off site. If there is not 100 mm water clarity, the water can either be:
 - Treated *in situ* until the clarity is achieved and then pumped off site
 - Pumped to a sediment retention device, tank or skip for settlement or flocculant treatment device before discharge offsite. (Note: If pumping to a decanting earth bund or sediment retention pond, the outlet should be blocked or otherwise prevented from discharging until it has been checked that 100 mm clarity has been achieved before the water is released.)
 - Pumped to a tanker and removed offsite
- Water clarity can be measured using a black target (such as a black disc). The further away the disc can be seen, the clearer the water
- Small volumes of water can be pumped via dewatering bags or pipe socks
- Larger volumes of water can be pumped to a turkey nest for treatment prior to discharge
- Ensure that the outlet to any pumped water is not creating any erosion issues. In some cases, an energy dissipater and a stabilised area may need to be constructed in the area where pumped flows exit into the receiving environment
- Monitoring the discharge is critical to ensure the pumped discharge is meeting the required discharge standards at all times
- Take particular care with pumping, as it produces fine-textured sediments that are very difficult to retain on site
- Sediment retention measures are far less effective for controlling dewatering than erosion control measures (i.e. those that reduce dewatered volumes)
- Ensure that any devices that receive pumped flows are suitably sized and appropriately located. Remember that these devices can hold a significant weight of water when full
- Ensure that pump outlets are securely connected or fixed to any device receiving these flows
- Dewatering requires close supervision and if not monitored, has potential to go wrong fast!

Due to the above limitations, all dewatering should be undertaken in accordance with a dewatering plan prepared by a suitably experienced and qualified professional. This dewatering plan needs to include the following details as a minimum:

- Specific dewatering procedures and methodology
- Dosing rates and batch dosing methodology if flocculant treatment is required
- Monitoring, and contingency measures (including a record sheet).

G2.0 Small sites

Users should refer to Auckland Council’s small-sites guide ‘*Building on small sites – Doing it right*’ (Auckland Council, 2016). Provided in both English and Chinese, it provides specific advice on best practice ESC for small earthworks sites, such as housing/building sites.

As with all earthworks, a combination of multiple ESC practices will be required to effectively manage a small site (a ‘treatment train’ approach). Further detail on those practices of particular relevance to small sites can be found in the following sections of this guideline:

- Erosion control practices:
 - Non-structural approaches (refer Section E1.0)
 - Clean and dirty water diversion channels and bunds (refer Sections E.2.1 and E2.2)
 - Stabilised entranceways (refer Section E2.6). (Note: Achieving the specifications detailed in Section E2.6 may be different on a small site. The dimensions of a stabilised entrance on a small site will be dictated by the available space. The stabilised entranceway should be designed to provide for likely vehicle movements to the site in accordance with the design purpose, and seek to achieve the outcomes detailed in Section E2.6.1).

- Sediment control practices:
 - Silt fences (refer Section F1.3) (refer Figure 108)
 - Super silt fences (refer Section F1.4)
 - Stormwater inlet protection (refer Section F1.6).

- Specific activities:
 - Dewatering (refer Section G1.0).



Figure 108: Silt fence

G3.0 Roads and utilities

G3.1 Roads

G3.1.1 Unique nature of roading works

Large roading projects, or roads constructed at the time of a new subdivision development, are not generally space-constrained. The conventional ESC methods and devices described in Sections E and F are generally applicable to these earthworks activities.

However, roading upgrades, repairs or realignments in an existing urban environment have unique challenges. ESC for such works is not always as straightforward as it is for general construction.

There are a number of aspects of roading projects that can be considered unique. These include:

- Road projects are linear projects that may cross a number of catchments
- Roding networks can be overland flows paths and works may alter existing drainage patterns
- Works within stormwater flow paths are immediately above, in and around, stormwater inlets
- The works are constrained in the amount of space they occupy
- Works are often undertaken within a 'live' traffic environment
- There may be numerous adjacent properties or land-use activities
- Earthworks areas and volumes associated with road upgrades are often not large in any one area; however, the long and linear nature of roading projects can have a cumulative effect.

For these reasons, roading construction can be more complicated from an ESC perspective relative to general construction projects.

G3.1.2 Best practice ESC for roading works

In existing urban environments, there is often limited space for construction of conventional sediment-control devices. The emphasis is on utilising a 'cut and cover' methodology and stabilising exposed areas at the end of each day's operations. Depending on the extent and nature of the works, they can often be limited to works within the subgrade or widening operations that allow for a cut to waste and replace with a stabilised product (aggregate).

Design

Consider the following points when planning and designing for roading activities:

- Plan works to minimise the extent and duration of site disturbance, particularly in high-risk areas such as close to watercourses and on slopes steeper than 18%
- Pumping groundwater and rainwater out of trenches or excavations generates sediment-laden water that can be difficult to treat in the roadway or limited berm areas. Refer to Section G1.0 for advice on dewatering
- Consider the limitations of space as a result of site-specific issues (Figure 109) including traffic management, pedestrian access, and access to commercial and residential properties
- In the urban environment, the location of buried services and proximity of trees can have an influence on the selection of ESC devices.



Figure 109: Progressive stabilisation in limited space

Construction and operation

Address these aspects when undertaking roading activities:

- There is often limited space for construction of conventional sediment-control devices. The emphasis is on utilising a “cut and cover” methodology and stabilising exposed areas at the end of each day’s operations
- Focus on erosion control and stabilise areas as soon as possible (refer Figure 110). Consider material selection for filling operations (i.e. use of hardfill)
- Topsoil and spoil should be stockpiled separately
- Do not put stockpiles of topsoil, spoil or bedding material in overland flow paths or within 1 m of a hazard area such as kerb and channels, stormwater inlets, paved footpaths or driveways
- Any stockpiles that remain on site must be covered with a geotextile fabric at the end of each day or when rain is forecast



Figure 110: Use of stabilisation products and progressive stabilisation

- Remove excess spoil and/or undercut material from the site as soon as possible, or immediately incorporate it into other works on site. Where possible, all excavated material that is not required as part of the backfill should be loaded directly onto a truck and removed off site
- Stabilise exposed areas as soon as possible (aggregate for carriageway and footpath areas and topsoil, seed and mulch/geotextile for landscaping and berm areas)
- Backfill and compact trenches or excavations as soon as possible in an immediate and progressive manner. (Note: Open trenches in an existing urban environment can also be a health and safety issue.)
- Dewatering of trenches or excavations must not pollute any stormwater system or downstream watercourse. Pump sediment-laden water to a retention device for treatment and/or removal, or direct it to a tanker for appropriate off-site disposal. Refer to Section G1.0 for more information on dewatering
- Take care with use of lime and cement to avoid discharges into stormwater or waterbodies.

G3.2 Utilities

G3.2.1 Unique nature of utility works

Unless correctly planned and managed, installation of services and utilities such as electricity, gas, water, wastewater and telecommunications can result in significant disturbance to the ground surface. Soil erosion and sedimentation are common environmental impacts of trenching and dewatering of trenches.

During new subdivision development, installation of utilities and services generally takes place towards the end of the bulk earthworks phase. Trenching works may, therefore, traverse areas that have already been stabilised, and in some cases, areas where sediment control measures have already been decommissioned. The trenches are often long and can cut across different water catchments.

In addition, utilities are constantly being upgraded or installed across the existing urban environment within the city's berms and road reserves.

Earthworks associated with the installation of utilities are usually fairly minor in any one area, but can create a cumulative effect. The works are often undertaken along roads and close to stormwater inlets. Pumping groundwater and rainwater out of trenches generates sediment-laden water that can be difficult to treat in the roadway where these works are usually done. Section G1.0 provides advice on dewatering.

G3.2.2 Best practice ESC for utility works

Design

Consider the following points when planning and designing for installation of utilities.

New subdivisions

- Install reticulation systems for water supply, stormwater and wastewater services and for other services and utilities at the same time as road works
- Co-ordinate installation of services and utilities with all relevant service providers and authorities, and where possible, use common trenching
- Make sure that trenching operators working on a larger site are aware of the ESC Plan for the overall site. They should understand that they must comply with its provisions as well as with any specific ESC requirements for their work
- Trenching across flowing streams or watercourses should be avoided. Use an alternative methodology such as directional boring or aqueducts in these situations
- In areas where ephemeral water is likely to concentrate, a dam should be created above the site with sandbags or similar. Works can then commence, and the surface reinstated with a stabilised surface
- Plan the works to minimise the extent and duration of site disturbance, particularly in high-risk areas such as close to watercourses and on slopes steeper than 18%
- When trenching is completed independent of other activities on site, plan for progressive stabilisation and/or restoration of disturbed areas
- Trenches should not be open for any longer than three days; complete the stabilisation of all disturbance in high-risk areas within two days of backfilling, and within five days in all other areas.

Existing urban environments

- There is often limited space for construction of conventional sediment-control devices. The emphasis is on utilising a “cut and cover” methodology and stabilising exposed areas at the end of each day’s operations
- Do not trench across flowing streams or watercourses. Use an alternative methodology such as directional boring or aqueducts in these situations
- Plan the works to minimise the extent and duration of site disturbance, particularly in high-risk areas such as areas close to watercourses and on slopes steeper than 18%
- When trenching has been completed independent of other activities on site, plan for progressive stabilisation and/or restoration of disturbed areas
- Trenches should not be open for any longer than possible; complete the stabilisation of all disturbed areas in an immediate and progressive manner. (Note: Open trenches in an existing urban environment can also represent a safety issue.).

Construction and operation

Address the following aspects when installing utilities (also refer Figure 111 below):

- If trenching works affect pre-existing ESC measures, those measures must be carefully removed and then immediately reinstated at completion of the works
- Additional ESC contingency measures will usually be needed for duration of the trenching activities, and until the original measures are reinstated or replaced
- Where practicable, plan and undertake works in appropriately sized stages so that trenching is not open for a period longer than three days and can be stabilised within the range specified above
- Do not open trenches when there is a risk of high rainfall. (Note: An open trench becomes a diversion drain; consider where it will discharge.)
- Divert above-site water away from work areas with temporary diversion drains (refer Section E2.1). Do not allow the trench excavation to concentrate or convey runoff
- Topsoil and spoil should be stockpiled separately on the up-slope side of the trench
- Do not put stockpiles of topsoil, spoil or bedding material in overland flow paths or within 1 m of hazard areas such as kerb and channels, stormwater inlets, paved footpaths or driveways
- Minimise soil loss by protecting all stockpiles with covers such as geotextile fabric
- Remove excess spoil and/or bedding material from the site as soon as work is completed, or immediately incorporate into other works on site
- Backfill and compact trenches within three days and stabilise the area as soon as possible
- Dewatering of trenches must not pollute any stormwater system or downstream watercourse; pump sediment-laden water to a sediment retention device or to a tanker for appropriate offsite disposal. Refer to Section G1.0 for more information on dewatering.

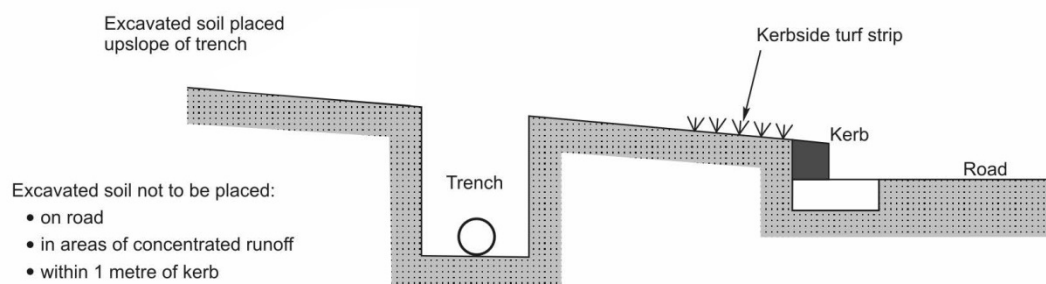

Figure 111: Typical trenching methodology

G4.0 Works within a watercourse

G4.1 Unique nature of this activity

Works in, or around, streams have potential to have a direct impact on watercourse habitat by habitat disturbance or destruction, and on watercourse ecology (such as through sediment and temperature-related effects).

Care is therefore required for works in and around watercourses to minimise potential effects as much as possible. Where this is unavoidable, specific construction methodologies and control measures are required to minimise potential adverse impacts. For guidance on fish relocation or fish passage issues, please refer to Technical Publication 131 (TP 131) – *Fish Passage Guidelines for the Auckland Region* (Auckland Regional Council, 2000).



Figure 112: Temporary stream diversion to allow for the installation of a new culvert

G4.2 Best practice ESC for works in a watercourse

Permanent crossings must be constructed in accordance with all relevant design and regulatory requirements.

When considering temporary works in watercourses, there are a number of different activities that need to be considered:

- Temporary watercourse crossings
- Dam and pump or dam and divert
- Temporary watercourse diversions (refer Figure 112 and Figure 113).

G4.2.1 Temporary watercourse crossings

Temporary watercourse crossings comprise temporary culverts or bridge structures installed across a watercourse for short-term use by construction vehicles.

Temporary watercourse crossings provide a means for construction vehicles to cross watercourses without moving sediment into the watercourse or directly affecting the streambed, generally while the new permanent crossing is installed.

Design

The following design criteria apply to this practice:

Location

If a watercourse crossing is required, select a location where the potential effects of the crossing (including construction) are minimised. That is, the ESC measure should be located in a section of the watercourse that is proposed to be modified as part of the permanent design.

Timing

Plan watercourse crossings well before you need them. Construct them during periods of dry weather and outside fish migration seasons (unless other timing is stated in a resource consent condition). The Department of Conservation and Fish and Game New Zealand can help identify these periods for particular watercourses. Complete construction as rapidly as possible and stabilise all disturbed areas immediately during and following construction.

Bridges

Where available materials and site conditions are adequate to bear the expected loadings, bridges are preferred over culverts (refer Figure 114). Bridges provide less obstruction to flow and fish migration, cause little or no modification of the bed or banks, and generally require little maintenance.

However, bridges can be a safety hazard if not designed, installed and maintained appropriately. Specific engineering design is required for all bridge structures.

Typically, control measures are placed between any soil disturbance needed to build the bridge or abutments and the stream channel. The control measures might consist of a super silt fence (refer Section F1.4) or bunds that drain to a decanting earth bund (refer Section F1.2).



Figure 113: Stabilised clean water diversion and temporary culvert to divert streamflows while a new culvert is being constructed



Figure 114: A temporary bridge in the process of being installed

Culvert crossings

Culverts are the most commonly used type of temporary watercourse crossing and can be easily adapted to most site conditions (refer Figure 115). However, the installation and removal of culverts causes considerable damage to watercourses and can also create the greatest obstruction to flood flows and fish passage. As far as practicable, the temporary culvert should be located in a section of the watercourse that is to be modified as part of the permanent design (i.e. a section of stream that may be filled as a result of a new culvert crossing).

When installing a temporary culvert, sizing is important as stormflows could cause erosion or overtop the culvert causing failure of the temporary access.

For temporary stream crossings, the cross-section of the culvert should be sized for approximately 85% of the channel cross-section.

To ensure minimal adverse impacts, scour protection is also required to ensure the integrity of the crossing in the event of overtopping.

Consideration must be given to overland flowpaths to ensure that larger flows do not cause excessive safety or environmental impacts. This will typically include confirming that in larger floods, there is no increase in flood level upstream (up to the 1% AEP storm in flood-sensitive areas).

Even though culverts are temporary, ensure that fish passage is not impeded in permanent streams (refer to TP131 for details).

As well as ESC measures, structural stability, utility and safety must also be considered when designing temporary watercourse crossings. In addition, it is likely that consents will be required for the construction of the proposed crossing. Auckland Council planning staff can assist in determining whether this is the case. Any temporary crossing must comply with the conditions of consent or the Auckland Council planning rules.

Streamflows will need to be diverted during installation of the temporary culvert so that the works can be undertaken in dry conditions. Refer to Sections G4.2.2 and G4.2.3 for methodologies to complete streamworks in dry conditions.

Maintenance and decommissioning

Inspect temporary watercourse crossings after rain to check for any channel blockages, erosion of the banks, channel scour or signs of instability. Make all repairs immediately to prevent further damage to the installation.

When the structure is no longer needed, remove it and all material from the site. This will largely be undertaken in reverse of the installation methodology. Streamflows will need to be diverted while the removal and reinstatement of the stream is underway. Refer to Sections G4.2.2 and G4.2.3 for methodologies to complete stream works in the dry.



Figure 115: In the process of constructing a temporary crossing

Immediately stabilise all areas disturbed during the removal process by revegetation or artificial protection as a short-term control measure. Keep machinery clear of the watercourse while removing the structure.

G4.2.2 Dam and pump or dam and divert devices

A dam and pump or a dam and divert are temporary practices used to convey surface water from above a construction activity downstream of that activity (refer Figure 116).

These diversion methodologies will assist in providing dry working conditions for culvert installation. Damming a stream and pumping the flows around the worksite back to the stream considerably minimises disturbance relative to constructing a new diversion channel. With high flow streams, diversions are sometimes the only option; however, with most small streams, damming and pumping are less harmful to the environment and relatively simple to carry out. A dam is also essential to temporary waterway diversions that are discussed in Section G4.2.3.



Figure 116: Water being diverted past a construction works area

Design

The dam is constructed across the stream with stabilised materials such as sandbags, sheet metal plate or other suitable construction materials. A pump is installed in the dam and sufficient hose length must be available to reach below the extent of in-stream works (refer Figure 117). The pump inlet should be placed in a drum with holes to minimise the possibility of sucking sediment from the bottom of the dam. Inclusion of a fish screen is recommended. The outlet should be directed to a stabilised area with an energy dissipater such as rip-rap boulders or similar.

A dam and pump methodology can only be used for works with a short duration or where the site can be stabilised at the end of each work day, so that flows can continue through the stream channel. Generally, it is not considered appropriate to implement a dam and pump methodology where the pump is required to be operating day and night for the duration of the operation (due to noise and pump reliability issues).



Figure 117: Commencement of over pumping to allow for in-stream works

Sizing the pumped diversion for a given storm event depends on the duration of the stream diversion. As a minimum, the temporary pumping should be sized for a one-year peak discharge from the contributing catchment. These design parameters are based on the assumption that full channel 5% AEP (20 year) capacity is made available overnight or when storm events are predicted.

Construction and operation

Consider the following when construction and/or operating these devices:

- The dam must be capable of holding back the incoming flows
- The pump must be capable of conveying the flows, as overtopping the dam will cause environmental and construction issues with flows passing through the work site.

G4.2.3 Temporary watercourse diversions

These short-term watercourse diversions allow work to occur within the main watercourse channel under dry conditions (refer Figure 118).

Temporary waterway diversions enable in-stream works to be undertaken without working in wet conditions and without moving sediment into the watercourse.

Temporary watercourse diversions are used as temporary measures to allow any works to be undertaken within permanent, intermittent and ephemeral watercourses.



Figure 118: Examples of temporary stream diversion installed to allow permanent culverts to be installed off-line

Design

These measures seek to divert all flow via a stabilised system around the area of works and discharge it back into the channel below the works to avoid scour of the channel bed and banks. Figure 119 to Figure 122 show the suggested steps to minimise sediment generation and discharge from works within a watercourse.

Step 1

The diversion channel should be excavated leaving a plug at each end so that the watercourse does not breach the diversion.

Size the diversion channel to allow for a 5% AEP rain event, but consider the implications for secondary flow paths and upstream flood effects of having a larger event, up to 1% AEP.

The diversion channel should be appropriately stabilised to ensure it does not become a source of sediment. Suitable geotextile cloth (as discussed in Section E3.5) should be anchored in place to the manufacturer’s specifications, which will include trenching into the top of both sides of the diversion channel to ensure that the fabric does not rip out.

Once the channel is stabilised, open the downstream plug to allow water to flow up the channel, keeping some water within the channel to reduce problems when the upstream plug is excavated. Then open the upstream plug, allowing water to flow into the channel.

Step 2

A non-erodible dam should be placed immediately in the upstream end of the existing channel. The dam should be designed as specified in Figure 123. Where a compacted earth bund is used, it must be stabilised with an appropriate geotextile pinned over the upper face and adjacent to the lower face for scour protection. In most cases, sandbag dams can be used to construct the dam. If there is a need to relocate fish trapped in the existing watercourse as a result of the diversion, please refer to TP131.

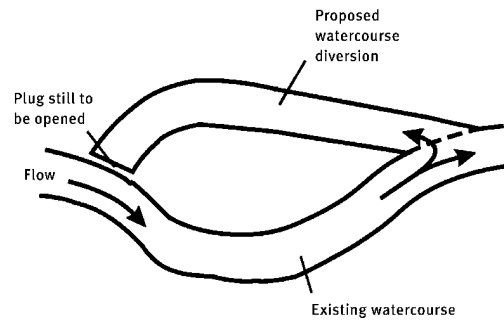

Figure 119: Diversion channel prior to plug removal

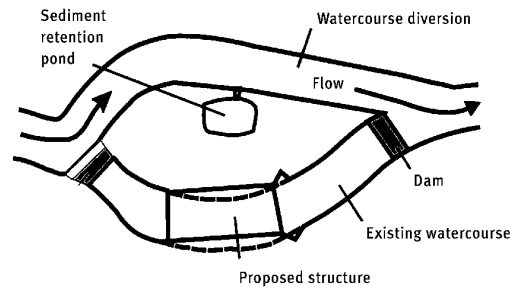

Figure 120: Dewatering construction area into a sediment pond

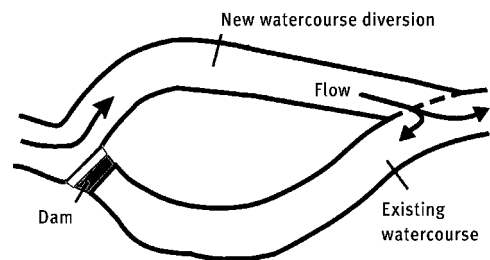

Figure 121: Opening up bypass channel and closing off existing one

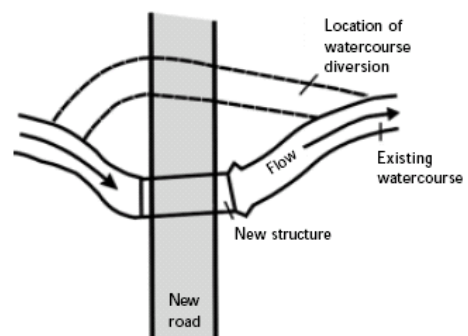

Figure 122: Re-establishment of flow in original channel

Step 3

A non-erodible downstream dam should then be installed to prevent backflow into the construction area. The existing watercourse is subsequently drained by pumping to a sediment retention pond, where the ponded water can be treated before it re-enters the live section of the watercourse. The structure and all channel works are then completed.

Step 4

The downstream dam should be removed first, allowing water to flood back into the original channel. The upstream dam is then removed, and both ends of the diversion channel are filled in with non-erodible material. Any sediment-laden water should be pumped to a sediment retention pond or dewatered (refer Section G1.0). The remainder of the diversion channel should be filled in and stabilised.

Coffer dam diversions

In some circumstances, partial diversion of a watercourse is required to allow for the construction of outfall structures or stream bank retaining works. In these situations, a coffer dam may be used to create a dry working environment to complete the works (refer Figure 123).

Generally, the coffer dam will be constructed within the streamflows. As such, it needs to be of non-erodible material such as sandbags, sheet piles or similar. Once complete, the water retained by the coffer dam within the work area is pumped out to provide the dry working area. Any dirty water within the coffer dam during the works will need to be pumped to a sediment retention device (refer Section G.10 – Dewatering).

The coffer dam design will need to assess the height of water to be diverted including any likely increased flows within the construction period.

Maintenance

Any works within a watercourse require ongoing and vigilant maintenance to minimise sediment generation. To achieve this, identify and correct any signs that may indicate a potential problem. Take notice of the following signs and make repairs immediately:

- The geotextile lining ripping
- Scour occurring where the flow re-enters the channel
- Undercutting of the diversion lining.



Figure 123: Sandbag coffer dam installed to complete stormwater outfall

G5.0 Winter earthworks

G5.1 Planning and management of winter works

While large rain events often occur during summer, the most frequent and overall greatest amount of rainfall in the Auckland region occurs from late autumn to early spring creating a greater risk of sediment generation and discharges from earthworks sites. In turn, there are greater challenges to adequately manage sites and minimise off-site effects. Winter also presents challenges in working, drying and compacting fill, and managing streamworks during periods of higher and more frequent flows. For these reasons, winter works require careful planning and management, based on the following principles:

- Plan the project to minimise earthworks and avoid streamworks during winter
- Be realistic about the works that can be achieved during the winter period
- Stabilise as much of the site by 30 April to minimise the works area over winter
- Design for topography considering that low gradients and short slopes will be easier to manage than long or steep slopes
- Understand what controls will be used to manage winter works areas and what additional controls can be implemented to further reduce the risk of sediment discharges from the site
- Ensure the controls can be accessed for maintenance during continued periods of wet ground conditions
- Design to progressively stabilise areas to minimise the area exposed to erosion
- Ensure winter works areas will minimally impact the receiving environment.

G5.2 Applying for winter works approval

Resource consents often include conditions that prevent earthworks occurring on the consented site between 30 April and 1 October, unless specific approval is given by Auckland Council. To obtain approval, contractors or consent holders must submit an application to Auckland Council to carry out winter works. The application is normally required to be submitted at least two weeks before 30 April and include supporting information. Before lodging the application, it is important to discuss the likely winter works requirements with an Auckland Council compliance inspector. This will provide a good lead time for site planning and the approval process. The Auckland Council compliance inspector will be able to provide useful guidance on the issues to consider, and the process to follow, and will be a key person in deciding if the winter works application is granted.

An application for winter works approval must address the matters listed in the following section. Applications for winter works approval are assessed on their merits. Do not assume that winter works approval will be given by Auckland Council and it is given as an exception.

Reason for winter works

- Be realistic. The intention of placing restrictions on winter works is to minimise the risk of erosion and sediment discharges to receiving environments. Accordingly, Auckland Council is unlikely to approve an application for extensive areas of earthworks through winter
- If bulk earthworks are to be undertaken during winter, the reason for that must be clearly described to Auckland Council. Poor planning or programming are unlikely to be considered acceptable reasons for winter works approval.

Avoid streamworks

- The highest average and continuous flows in streams occur during winter. Consented streamworks will be required to occur before winter and it is unlikely that Auckland Council will grant approval to undertake streamworks in winter. Plan to have streamworks completed by 30 April.

Track record and site management

- The request for winter works approval needs to consider the site's compliance history, and how any previous non-compliance issues have been addressed and will be avoided during winter. This may include upgrading controls or re-assigning management of erosion and sediment control to different personnel
- Describe the monitoring and maintenance programme that will be implemented during the winter works, weather forecasting, pre-storm preparation, pre- and post-event inspections, frequency of de-silting of treatment devices, disposal of excavated sediment, and emergency response procedures
- Provide names and contact details of the personnel undertaking that work, and who has overall responsibility for ensuring compliance with the requirements of a winter works approval.

Minimise exposed areas

- Plan and describe how the works areas will be minimised and progressively stabilised to minimise the area of exposure. This is a critical aspect of winter-works management and approval
- Identify the source and availability of stabilisation (e.g. mulch), including at short notice.

Soil type

- Consideration of soil type must be included in the winter-works request. Clay-based soils are considered to present an elevated risk, whereas sandy soils or rock have higher permeability and less erodibility. Understanding the site's soils will assist in identifying the correct management and controls.

Slope

- The site's topography is a key consideration in assessing applications for winter works. Flat or low gradient sites present a lower risk of sediment generation and discharge. Conversely, steep sites present a high risk. Likewise, longer slopes present a high risk of sediment generation, as they generate higher volumes of runoff and concentrated erosive flows
- Assess the slopes across the site, and the proposed staging (area and timing) so that works on the steepest and longest slopes are avoided or minimised.

Programming and risk

- Areas of highest potential risk must be identified, and the request must explain how works in these areas have been programmed to avoid, to the best extent practicable, adverse weather events. Such areas will include steeper and longer slopes and works immediately adjacent to water bodies or neighbouring properties.

Receiving environment

- Consider the proximity and characteristics of the receiving environment and explain how this has been addressed in planning and programming the works. Winter works should be avoided where they are located within close proximity of high-value receiving environments or present an increased risk of sediment effects on neighbouring properties.

Site access

- Identify how erosion and sediment controls will be accessed and managed throughout winter. It's critical that controls can be accessed and maintained, including removing sediment, when ground conditions are wet.

Chemical treatment

- Specify what additional treatment may be implemented and detail any increased monitoring and maintenance requirements for the treatment system
- An updated Chemical Treatment Management Plan may be required
- Ensure adequate quantities of the appropriate chemical are on site and easily accessible.

Erosion and sediment control plan

- An application for winter works approval must include an updated Erosion and Sediment Control Plan and Methodology Statement that specifically addresses the winter works areas, taking account of the factors discussed above. It may be necessary to provide a series of plans that reflect the various stages of winter works, and how areas will be completed and stabilised
- The winter works Erosion and Sediment Control Plan must include simple, clear instructions to personnel on how the works will be implemented and managed. Discuss the content of the winter works Erosion and Sediment Control Plan with the Auckland Council compliance inspector before it is prepared and submitted.

G6.0 Quarrying

G6.1 Unique nature of this activity

Quarries can present a major source of sediment, with activities such as overburden removal and aggregate handling identified as higher-risk tasks. Quarries are often long-term operations, with a point-source discharge from the site. Sediment-laden discharges from quarries have potential to affect receiving water quality if they are not adequately managed.

The following quarry activities can cause sediment generation, and are addressed in more detail below:

- Road establishment and access (including watercourse crossings)
- Overburden removal and disposal
- Quarry-product stockpile management
- Traffic management (tracking sediment onto public roads)
- Rehabilitation of worked out/completed areas.

This section provides a series of prompts to help quarry operators and their advisors understand and assess options for ESC. It should be read and implemented having regard to the principles of ESC (Section A2.0) and Sections E and F of this guideline, which detail specific ESC practices.

G6.2 Best practice ESC for this activity

G6.2.1 Quarry access

Many quarries in the Auckland region are serviced by all-weather metal roads. Establishing these roads and their use can generate a lot of sediment. Watercourse crossings need to be authorised as a permitted activity or by a resource consent. Quarry access roads are not always within the designated quarry area, but their maintenance and upkeep should be addressed in the Quarry Management Plan.

Standard ESC principles and planning (refer Section A2.0) apply to the construction of access tracks or roads. ESC measures need to be used where sediment is generated from the use of these tracks (refer Part 2, Sections E and F). Typical measures include the use of rock check dams in roadside drains (Section E2.4), and diversion of the dirty water to a storm retention pond (Sections E2.2 and F1.1) or decanting earth bund (DEB) (Section F1.2). Truck wash bays and run-out areas may be needed to ensure sediment is not tracked onto public roads. Where possible, incorporate site access into the Quarry Management Plan, including details of all maintenance requirements.

G6.2.2 Managing clean and dirty water

Refer to the key principles of ESC (refer Section A2.0) when developing the Quarry ESC Plan. Keep as much water clean as possible. This can be achieved by limiting the exposure of erodible surfaces and ensuring all dirty water is diverted to suitable treatment devices prior to discharge.

Clean water

Divert all clean (up-slope) water away from working and bare areas, if possible, to prevent it from entraining sediment. This will reduce the volume of contaminated runoff to be managed and treated. Channels to divert clean water around the working site, as outlined in Section E.2.1, are often the best means of managing these flows. Plan for these channels to be relocated, in the event that the quarry footprint changes over time.

Sediment-laden water (quarry water runoff)

Any runoff from bare soil areas, rock processing and aggregate wash processes must be managed and treated appropriately before discharge to the receiving environment. The ESC Plan should detail the methods for sediment control (refer Section F). Attention should be given to sensitive areas such as permanent watercourses, watercourse crossings (refer Section G4.0) and steep areas.

Due to the texture of Auckland soils and fine particles generated from quarrying activities, sediment retention ponds with flocculant treatment are likely to be the most successful and reliable method of treating and retaining sediment (refer Sections F1.1 and F2.0), especially for sites with a water quality discharge standard. Ensure the structural integrity of any such pond is carefully planned for and fully engineered.

Similar to clean water management, proactively plan to manage flows to sediment retention ponds and associated water treatment (such as a flocculation plant), if the quarry footprint/sediment pond catchment changes over time.

Ensure that where catchment areas are anticipated to increase, the sediment retention pond is either initially constructed for the greatest anticipated catchment, or that there is sufficient space to allow the pond to be enlarged.

G6.2.3 Overburden removal and disposal

Overburden is the material that lies above the targeted rock or mineral resource. Overburden removal and disposal activities are generally the same as earthworks cut-and-fill operations and should comply with normal earthworks requirements. The ESC principles in Section A2.0 should be adhered to, with detailed ESC Plans prepared and implemented prior to and during the operation.

G6.2.4 Quarry product handling and stockpiling

Quarry product handling and stockpile areas can be a major source of sediment-laden runoff if not properly controlled. Incorporate these areas into the Site ESC Plan.

G7.0 Agriculture (farm tracking)

The construction and maintenance of farm tracks will generally require earthworks. While the volume of these earthworks will generally be low, as with all earthworks, the potential and/or actual effects of erosion and sediment discharge need to be minimised. The general principles of ESC in Section A2.0 should be applied to all farm tracking earthworks.

In addition, the following sections of this guideline provide further reference for ESC practices appropriate for use during farm tracking:

- Erosion control practices:
 - Non-structural approaches (refer Section E1.0)
- Sediment control practices:
 - Decanting earth bunds (refer Section F1.2 and Figure 124)
 - Silt fences (refer Section F1.3)
- Specific activities: Works within a watercourse (refer Section G4.0).



Figure 124: Decanting earth bund and diversion bund installed during a farm track construction

G8.0 Soil binders

G8.1 Unique nature of this activity

Soil-stabilising agents (also known as soil binders) are used to form a cohesive membrane or protective crust that reduces windblown dust generation.

The purpose of soil binders is to prevent, or reduce, the movement of dust from disturbed soil surfaces that may create health hazards, traffic safety problems and offsite damage. They may also reduce the effect of raindrop erosion and therefore, minimise sediment runoff. However, the effectiveness of their use for this purpose has not yet been verified.

Soil binders may be liquid or powdered products, either organic (e.g. guars, latex or various other timber resins) or chemical (e.g. acrylic copolymer or anionic bitumen emulsions or cementitious gypsum- or lime-based products). They are used to provide short-term protection of stockpiles, steep or relatively unstable slopes, compound areas, and inactive haul roads, etc. Some binders may also be included in hydroseeding or hydromulching operations to tack seed and/or wood fibre to the soil surface on steep slopes. A granular form of calcium or magnesium chloride may also be used to absorb atmospheric moisture and suppress dust on active haul roads and access tracks.

Soil binders can be used anytime where protection of the soil surface is desired; although the following conditions are generally applicable:

- Use soil binders and chloride dust suppression agents where short-term protection is required; generally less than 6 months
- Use soil binders and chloride dust suppression agents where almost instant dust protection is required
- **Do not** use soil binders where the established soil crust is likely to be damaged
- **Do not** use soil binders or chloride dust suppression agents in areas of concentrated flow or in areas where periodic inundation is likely to occur
- **Do not** use soil binders or chloride dust suppression agents immediately next to streams or other water bodies.

The following limitations apply to soil binders:

- If managed well as part of a treatment train approach to site management, they can provide good dust control and may also reduce the effect of raindrop erosion. However, the use of soil binders does not constitute stabilisation of the site. Sediment controls will still need to be retained until the site has been stabilised (i.e. vegetated, sealed, or covered with aggregate or cloth)
- For soil binders to be effective, their surface crust must remain intact. Keep construction equipment and site vehicles, pedestrians, wildlife and/or livestock out of all treated areas
- Hardy colonising species, such as woody weeds, can break through the crust

- Anionic bitumen emulsions, some acrylic copolymer emulsions and chloride dust suppression agents have potential to pollute some sensitive receiving waters. Generally, these should not be used immediately next to streams or waterbodies. In some areas, the use of bitumen emulsions may conflict with established community perceptions.

G8.2 Best practice ESC for this activity

G8.2.1 Design

There is no formal design procedure for soil binders, and products on the market are constantly changing. The following general principles should be followed:

- Confirm with Auckland Council which products are acceptable for use. Use of soil binders or products should be undertaken in accordance with a documented Soil Binder Management Plan
- Follow the manufacturer's recommendations for application rates and procedures.

G8.2.2 Construction, operation and maintenance

Construction and operation

For application of soil binders, use the following procedures:

- Intercept up-slope runoff water and divert it around areas to be temporarily stabilised with soil binders
- Follow the manufacturer's recommendations for the correct application procedure
- Best results are obtained on friable soils. If necessary, lightly scarify the soil to allow the binder to fully permeate the soil surface. (Note: Adding a wetting agent may also help this.)
- Soil binders are generally mixed with water before application. Stir or shake powdered products
- Apply the solution over the area to be protected via the spray bar on a water cart, a hose with a fine spray nozzle, or through the cannon on a hydroseeder unit
- Establish temporary exclusion zones around areas treated with soil binders and clearly identify and/or signpost these. Discuss exclusion zones in routine toolbox meetings and at site inductions.

Maintenance

Inspect soil binders after each rainfall event or periods of excessively strong winds. In addition, inspect weekly and:

- Check for damage to the soil binder membrane caused by earthmoving equipment, construction vehicles, slips or slumps, inundation, ultraviolet degradation, livestock, wildlife or vandalism (motorcycles, four-wheel drives, etc.)
- Repair any damaged areas immediately by reapplying the soil binder, or by covering the damaged areas with a temporary mulch or blanket

- If necessary, erect temporary barrier fencing and/or signage to restrict uncontrolled movement of equipment and vehicles onto treated areas
- Check soil binding agents have not been removed by excessive traffic movements, track runoff during wet conditions, routine grading or other haul road maintenance activities
- Reapply as required to minimise dust generation.

G9.0 Dust control

G9.1 Unique nature of this activity

Dust control comprises the control of dust movement on construction sites. It is important to prevent or reduce the movement of dust from disturbed soil surfaces that may create nuisance, health hazards, traffic safety problems and/or offsite damage and discharge to the environment (refer Figure 125).

Areas subject to dust movement include open earthworks areas exposed to wind, stockpiles of materials, bulk materials handling or vehicle movements.

The effectiveness of dust control depends on moisture content and particle size of the soil or material, temperature, humidity and wind velocity/direction.

The availability of sufficient water is also critical to effective dust control. This is required to maintain the moisture content of surfaces and materials.



Figure 125: Forward planning and management to minimise dust provide the best options for control

G9.2 Best practice ESC for this activity

G9.2.1 Design

Forward planning and management to minimise dust problems provide the best options for control. If dust management is only addressed after it has become a problem on site, it is very difficult to bring under effective control until the site has been stabilised.

The following methods for dust control apply:

Water sprinkling

The most commonly used dust control practice; water is normally applied for dust suppression via a water cart or sprinkler system (refer Figure 126 and Figure 127).

Either system requires a minimum amount of water to achieve effective dust control.



Figure 126: Dust suppression using a water cart

The Ministry for Environment's (2016) *Good Practice Guide for Assessing and Managing Dust* recommends 1 litre/m²/ hour (or 1 mm/m²/hour) of water is available on-site for this purpose. However, this is generally considered conservative as the minimum amount of water that should be available on site is 5 mm/m²/ day. This should be applied incrementally so the ground surface remains moist.

Water carts can carry various volumes; however, their use is limited by the ability of the vehicle to access the areas that require wetting.

A sprinkler system may also be used where large areas are open or where the terrain is too steep for water carts. Sprinkler systems may also be used where irrigation is useful to establish vegetation following earthworks completion.

A reliable source of water is required. This can be sourced from sediment retention ponds or authorised water takes (e.g. bore, stream, lake or municipal water supply). Approval is required from Auckland Council to take from these supplies.

Soil binders

Soil-stabilising agents (also known as soil binders or polymers) can be used to form a cohesive membrane or protective crust that reduces windblown dust generation (refer Figure 128).

Follow the manufacturer's recommendations for suitability of products for each situation, application rates and procedures.

Further detail on soil binders is provided in Section G8.0.

Mulching, grass establishment and gravelling (progressive stabilisation)

Refer to Sections E3.4 and E3.3 for specifications on mulching and grass establishment.

Surface mulching can be used as a temporary mulch (e.g. straw) to cover stockpiles, or other areas not worked for an extended period. Otherwise it can be progressively applied in conjunction with permanent revegetation works. Site coverage can be extended to include gravelling of compound areas, haul roads and access tracks.

Temporary vegetative cover can be used on stockpiles or other areas not worked for an extended period. Otherwise, permanent vegetative cover can be progressively applied to completed areas. Vegetation will reduce wind velocity at ground level and stabilise the surface.



Figure 127: Snow blowing machine to provide dust control during a liming operation



Figure 128: Dust suppression using soil binders/polymers

Geotextiles

Geotextiles are discussed in detail in Section E3.5. Geotextiles can be used as a temporary cover (e.g. geotextile fabric) on stockpiles, or partially completed batter slopes. Otherwise, they can also be used as a permanent cover (e.g. vegetation promotion blanket) on completed areas.

Management practices

For a full description of recommended management practices for controlling dust, refer to the Ministry for the Environment's (2016) *Good Practice Guide for Assessing and Managing Dust*. Common practices include:

- Minimising the area of soil exposed to the wind by staging works across the site
- Limiting traffic to established haul roads and minimising travel distances by optimising site layout
- Controlling vehicle speeds
- Maintaining the surface of roads
- Minimising track out of dirt on vehicle wheels onto paved surfaces
- Minimising drop heights when loading and unloading vehicles
- Limiting the height of stockpiles
- Providing shelter from the wind for stockpiles
- Consolidating loose surface material.

G9.2.2 Construction, operation and maintenance

Construction and operation

The following specifications apply to installing dust controls:

- During periods of low moisture conditions, apply enough water to prevent dust generation without causing runoff (refer Figure 129)
- Once areas are damp enough to prevent dust generation, regularly apply enough water to replace that lost through evaporation. This will often be an ongoing operation
- Where dust suppressants, 'sealing off' areas or isolating areas are used as control measures, adequate controls are needed to isolate these areas from construction traffic or activities. This may include fencing, signage or bunding.



Figure 129: Water truck dampening down the works area



Figure 130: Regular wetting of the haul road

Maintenance

For maintenance of dust controls:

- As a minimum, monitor dust emissions daily. In windy, dry conditions, review dust emissions continuously
- Reapply water as required to effectively manage levels of dust generation, especially when soil moisture conditions become low during hot and windy conditions (refer Figure 130).



H Works within the coastal environment

Table of Contents

H1.0	Works within the coastal environment	173
H1.1	Unique nature of this activity	173
H1.2	Scope of this chapter	174
H1.3	General methods that can be used to control sediment in coastal environments	175
	H1.3.1 Good site practices	175
	H1.3.2 Works timing	175
	H1.3.3 Specific devices	176
H1.4	Activities which require specific control measures	178
	H1.4.1 Coast protection and rock armour structures	178
	H1.4.2 Dredging	178
	H1.4.3 Pilings and abutments	179
	H1.4.4 Trenching for pipelines and cables within 100 m of coast.....	180
	H1.4.5 Reclamation	181
	H1.4.6 Demolition of pre-existing structures	182
	H1.4.7 Mangrove removal	182
	H1.4.8 Beach replenishment	183
	H1.4.9 Dune management works.....	183
	H1.4.10 Managed realignment or retreat	184

Figures

Figure 131: Examples of geotextile filter layer beneath a rock revetment and use of rip rap	176
Figure 132: Sheet pile coffer dam	177
Figure 133: Water draining from a sheet pile coffer dam	177
Figure 134: Use of geotextiles and coastal protection rock.....	181
Figure 135: Dune reshaping	184

Tables

Table 18: Specific measures for reducing sediment plumes from different dredging activities	179
---	-----

H1.0 Works within the coastal environment

H1.1 Unique nature of this activity

This section focuses on typical works in, or around, the coastal environment. The coastal environment includes the Coastal Marine Area (CMA) (foreshore and seabed seaward of mean high-water spring and out to 12 nautical miles), as well as the transition area between land and marine environment. Works proposed for the coastal marine area may require engagement with Auckland Council. In these instances, applicants should discuss proposed works with Auckland Council early in the design stages to avoid and mitigate any potential impacts in the coastal environment. This chapter therefore focuses on the general framework rather than specific options. Key points of difference affecting the management of environment and sediment control in the coastal environment include the following:

- Earthworks is not a term used the coastal chapters of the Auckland Unitary Plan. Such activities are referred to as ‘disturbance’ or ‘dredging’ depending on the nature and purpose of the work
- There is no “restricted earthworks season”. In some cases, working during winter may be an advantage, but this needs to be balanced with the increased risk of storms and damage to the works from the resulting wave action
- Currents and wave action can release and distribute large quantities of sediment over large areas very quickly
- Naturally occurring suspended sediment in the water column may mask the impact of earthworks
- In estuaries, sediment can be very soft, making movement of machinery difficult. Multiple vehicle movements across fine sediments result in reduced substrate strength. Rescuing sunken machinery and equipment is not uncommon
- The foreshore and seabed is home to a complex ecology. Invertebrates within the substrate support threatened and endangered bird species, and fisheries. Ecological effects need to be considered
- Marine sediment has different physical and chemical properties to freshly eroded land sediments. They are typically more porous and well-oxygenated and because marine particles rub together, their edges are not as sharp. Therefore, the effects of marine sediments on marine biota are different to those of freshly eroded land sediment
- Deeper sediments can be oxygen-depleted and when disturbed, can increase oxygen demand
- Salt water is a natural flocculant for land-derived clay particles and can cause immediate deposition in sensitive near shore areas
- Auckland beaches are generally sand poor, particularly the east coast. Many beaches have thin sand layers; they are very dynamic and sand levels can fluctuate significantly. This dynamicity is driven by natural processes; waves and currents
- Storm events can strip sand from beaches. This is generally deposited in an off-shore bar and then remobilised back to the beach once more normal wave patterns return.

The fundamental principles of ESC, such as timing and staging of works, isolating the earthworks' site from clean water while minimising the discharge of dirty water, also apply to works in the CMA. However, traditional, land-based environment and sediment control measures are generally not appropriate for coastal works and require specific design and implementation.

H1.2 Scope of this chapter

This chapter provides guidance for small- to medium-sized works within the coastal environment. These works include constructing, maintaining and repairing structures such as:

- Boat ramps
- Jetties and wharves
- Walkways and small bridges
- Outfalls
- Seawalls
- Groynes
- Breakwaters
- Revetments and other coastal protection structures
- Small reclamations and beach recharge.

as well as other small-scale activities such as:

- Demolition of existing structures within the coastal environment
- Temporary works within the coastal environment, e.g. temporary piling or constructing bunds and coffer dams
- Trenching for the landward portion of cable and pipelines
- Some dredging activities
- Beach and dune reshaping
- Mangrove removal.

Larger-scale projects, or any project located in or close to a sensitive receiving environment (as defined by the Auckland Unitary Plan overlays) would require more detailed assessment of environmental effects and a site-specific mitigation plan. Progressing these projects will also benefit from comprehensive discussion with Auckland Council, beginning at the pre-application stage and continuing through to pre- and post-physical works.

Examples of these types of works include:

- Large coastal works including construction of ports, marinas and large sea walls/coastal protection structures
- Large-scale capital and maintenance dredging, including for ports, marinas and navigational purposes
- Large-scale beach replenishment and reclamation works
- Trenching for offshore pipes and cables
- Dumping and disposal of waste materials into the coastal environment
- Works close to sensitive areas such as marine farms, shellfish beds, fish hatcheries and spawning grounds.

H1.3 General methods that can be used to control sediment in coastal environments

There are a variety of practices to reduce sediment discharges generated from works in coastal environments. However, it is best to avoid generating sediment discharges in the first place. Where this is not possible, the following practices should be considered. Sediment control measures will likely be controlled, or informed, by resource consent requirements and any specific resource consent conditions.

H1.3.1 Good site practices

- Isolate the works where possible
- Keep the site clean and tidy: remove equipment, spoil and construction materials from the CMA at the end of each day
- Minimise the area of open works at any given time and stage works appropriately
- Ensure the selection of materials is appropriate (aggregates should be clean and sourced from a reputable supplier etc.)
- Store materials appropriately ensuring they are kept out of the CMA. If materials are stored on land, use sediment controls, e.g. silt fences, cover up stockpiles etc. If storage space is limited, consider scheduling delivery on an as-required basis
- All spoil should be captured, contained and removed from CMA immediately
- Protect open-cut faces at the end of each day, especially if high tides or bad weather are predicted.

H1.3.2 Works timing

The timing of works should be planned to minimise the extent and duration of the operation. Key considerations include:

- **Tidal windows:** Certain work may only be undertaken either side of the low tide with all works made stable prior to the next high tide. Tidal windows can also be used to help control the spread of sediment plumes to sensitive environments. An incoming tide will bring sediment released by the works towards the coast or into an estuary while an outgoing tide will take the sediment plume out towards the sea. Spring and neap tides can also affect works timing
- **Weather conditions:** Weather forecasts (including wind, swell and rain) should be checked frequently with works timed to be undertaken during calm conditions
- **Environmental windows:** These may include restricting works during fish spawning or bird breeding seasons. Environmental windows are often long-term restrictions over several months and may mean that work in some sensitive areas can only be undertaken during certain months, e.g. winter.

H1.3.3 Specific devices

Silt curtains

Silt curtains are similar to silt fences and comprise a long sheet (or curtain) of geotextile that is fine enough to let seawater through but will trap suspended silt particles. They are usually installed using floats on the top edge and fixing the bottom edge of the curtain to the seabed with weights or stakes. They can be used to isolate construction works or a piece of plant to avoid silt spreading from a work zone. Alternatively, silt curtains can be placed in front of a sensitive area to stop silt plumes.

Potential limitations on the use of silt curtains include:

- **Obstruction:** They should be installed away from construction activity in areas without causing a hazard to other coastal users
- **Currents:** They should be used in very sheltered areas with currents of less than 0.5 m/s and should be removed prior to significant storm events
- **Decommissioning:** Sediment trapped behind silt curtains should be removed prior to removal and the silt curtain should be completely removed and disposed of appropriately.

Geotextiles

Marine-quality geotextiles can be used as permanent filter layers in the construction of coastal structures such as rock revetments, groynes and breakwaters. The geotextile will protect the foreshore, seabed and prevent washing out of silts, fines and sands through the coastal protection structures (Figure 131).

A variety of marine-quality geotextiles are available for use as temporary protection. Any geotextile should be securely anchored in place with care taken to ensure no loss of any material.

Bunds

Temporary bunds can be an inexpensive option for reducing sediment discharge into the coastal environment. They can be constructed from surrounding material such as sands and gravels or, in some cases, from materials brought to the site, e.g. sandbags. The bunds should be designed to protect the working area from anticipated tide and wave action with care taken during construction to prevent adverse effects.

At decommissioning, all bunds should be dismantled, including the removal and disposal of any materials (such as sand bags) used in construction. Any associated disturbance must be remedied, and the site restored, i.e. if material is taken from the surrounding /adjacent foreshore.



Figure 131: Examples of geotextile filter layer beneath a rock revetment and use of rip rap
(SouthernSkies, 2018)

Coffer dams

Coffer dams are generally used for larger projects, especially those that require a water-tight barrier (e.g. sheet pile structure as shown in Figure 132), allowing works to take place in the dry. Their advantage is that sediment is not dispersed by coastal processes and works can be undertaken irrespective of tides.

Coffer dams can be significant structures and require specific engineering design by a suitably qualified coastal engineer. They are often very difficult to seal, and tidal water can continue to seep up under the dams through the marine muds (Figure 133).

The coffer dam should be sized and designed to protect the area from the tide until the area is stabilised. At decommissioning, all materials should be removed in a manner which minimises disturbance and possible discharges, and the site restored as appropriate.

Rock rip rap

All works requiring the use of rocks as support structures should be designed, constructed and decommissioned using best international practice and design standards such as the CIRIA Rock Manual (CIRIA; CUR; CETMEF, 2007), the US Army Corps of Engineers Coastal Engineering Manual (US Army Corps of Engineers, 2002) etc.



Figure 132: Sheet pile coffer dam

(SouthernSkies, 2018)

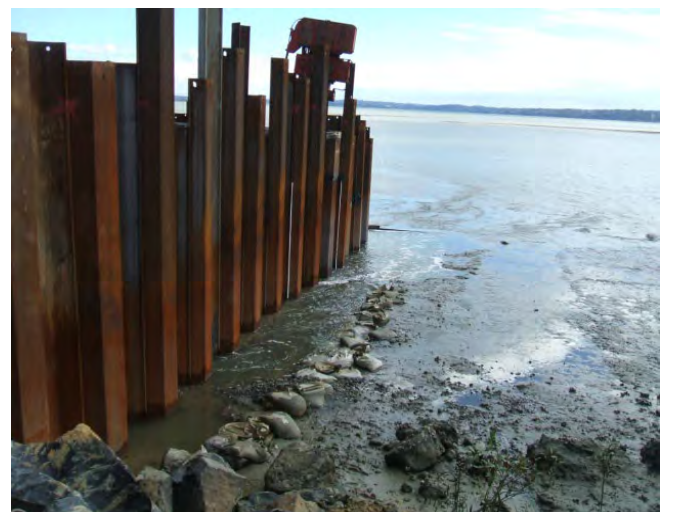

Figure 133: Water draining from a sheet pile coffer dam

(SouthernSkies, 2018)

H1.4 Activities which require specific control measures

This section addresses some of the more common coastal works in the Auckland region. It is not a comprehensive list.

H1.4.1 Coast protection and rock armour structures

Coastal protection works involve the construction of engineered structures to stabilise the coastline or provide shoreline protection from coastal processes (including coastal erosion, coastal inundation and the impacts of climate change). This includes:

- Seawalls
- Rock revetments
- Breakwaters
- Headland control structures or groynes
- Stormwater outfall scour protection structures.

Erosion and sediment control options during such works may include silt fences and curtains, bunds and geotextiles. However, such devices may be affected by coastal processes and may only be practicable for short durations during works. Coast protection and rock armour structures may require backfilling, geotextiles or stabilisation. Large rock rip-rap may be used to provide a stable base. Construction may require reshaping of banks or coastal edges. Larger works may require a coffer dam to be installed to create a dry working area.

Any designs should consider the following:

- Careful design of the footing or toe is needed with consideration of how the structure will be built (i.e. a coffer dam may be required for more detailed subtidal works)
- Consider crest-height design (to minimise overtopping scour)
- Designs may require stabilised rocks and should include contingency to withstand a partial collapse, or settlement during the lifetime of the structure.

H1.4.2 Dredging

Dredging is the disturbance and removal of settled sediments from the seafloor. This chapter provides guidance on:

- **Capital dredging:** Excavating material from the coastal marine bed and removing it, where the work is to provide increased water depths beyond existing approved levels or beyond natural levels where there is no existing approved level
- **Maintenance dredging:** Excavating material from the coastal marine bed and removing it, where the excavation is for the purpose of removing accumulated sediment so that the seabed is returned to previously approved levels.

This chapter does not provide guidance for dredging associated with large-scale projects (e.g. ports) and commercial extraction (such as gravels and sands and minerals).

Sediment disturbance will be caused by the actual dredging activities but can also occur if material falls from dredging equipment and spillages from loading and unloading dredged materials. Any dredging should be planned to limit the extent of sediment release, and ensure any effects are localised and temporary. As well as those practices detailed in Section H1.3, specific measures which can be used to reduce plumes from different types of dredger are presented in Table 18.

Table 18: Specific measures for reducing sediment plumes from different dredging activities

Methodology	Sediment reducing activity
Backhoe dredging	<ul style="list-style-type: none"> • Install visor screen on bucket • Limit swing area, e.g. distance from dredger to barge • Avoid dragging bucket along the seabed • Use silts screens if appropriate
Clam shell (grab) dredging	<ul style="list-style-type: none"> • Use a water-tight grab • Use a hydraulic grab • Limit swing area, e.g. distance from dredger to barge • Avoid dragging along the seabed • Use silts screens if appropriate
Suction dredging	<ul style="list-style-type: none"> • Optimise trailing velocity • Consider whether screening is appropriate • Reduce water intake / pump velocity • Consider using dredging plant with return flow equipment fitted (recycling) • Reduce air content in overflow material as this increases time taken for sediment to settle
Bucket ladder dredging	<ul style="list-style-type: none"> • Adjust / optimise bucket angle • Ensure discharges chutes are maintained • Install splash screens at end of chutes • Fit one-way valves in buckets

Adapted from: CIRIA. (2001). *Scoping the assessment of sediment plumes from dredging*. London: C547, CIRIA.

H1.4.3 Pilings and abutments

Piling works can require temporary staging to move the piling rig into position. The main environmental issues associated with piling relate to the auguring of marine muds from within the temporary casings and how this material is removed. Methodologies and procedures which may minimise the discharge of sediment during this process include:

- Having a location ready for temporary storage of excavated material (such as a skip or banded area) prior to removal to an approved location
- Including a dewatering tube or settlement tank that can be used to dewater pile excavations.

Minor reclamation or erosion protection works may be needed for preparation works where the abutments works are located within, or are adjacent to, the CMA (Section H1.4.1).

Consider the following points when planning and designing for coastal piling and abutment works:

- Minimise the extent and duration of the operation
- Consider the removal process of any temporary staging and any required remediation
- Detailed design is needed for abutment and abutment protection works.

Preparation and planning is critical. All piling operations (auguring and removal of the marine sediments, concrete pours and all other related concrete activities) are undertaken over water. Methodologies and procedures are required to ensure that neither sediment/concrete contaminated water or dust discharge into the coastal environment.

Staging screens and skips/bins can be used to manage the environmental effects. Any temporary staging should have kick boards installed and spill kits on the deck. Temporary staging will need to be removed after it is used, including the pilings.

H1.4.4 Trenching for pipelines and cables within 100 m of coast

Trenching methodologies include hydraulic jetting, mechanical cutting, or mass excavation, each of which has potential to produce large amounts of sediment. Backfilling may also result in high sediment loads being released into the environment. The level of adverse effects will vary depending on the receiving environment and should be measured in comparison to naturally occurring levels. In some instances, increased suspended sediments resulting from submarine trenching may be within the natural expected conditions. However, more sandy areas are vulnerable to the effects of elevated levels of suspended fine sediments.

Trenching can be done in the intertidal area (with work done above low tide, incrementally in-between tides) or below low-tide level (subtidal).

Where the works are undertaken in the intertidal area:

- Stage works around each low-tide period and allow time for materials and equipment to be removed
- Consider the tidal range in the location of work. If the works are located near the high tide level, a low coffer dam or bund around the work area may be needed
- Minimise disturbance to the foreshore when accessing the work area. For a muddy foreshore, a temporary causeway/access way or raised platform may be needed.

Where subtidal works are to be undertaken, consider:

- Installing a coffer dam to isolate the area and undertake the works in dry conditions. This will be largely dependent on the depth of water at the work location and the necessity of doing the works in dry conditions
- Undertaking the trenching in the wet, similar to a dredging operation, with the pipe laying or cabling undertaken remotely from the surface or by using divers. In this situation, limiting any sediment discharge is typically achieved by limiting the work area and duration.

Ideally, subtidal trenching works should be undertaken over periods of slack tide, rather than during peak tidal flows (such as an hour either side of low or high tide). To avoid increases in suspended sediment resulting from trench backfilling, appropriate backfill material should be used, such as sands or gravels.

H1.4.5 Reclamation

Reclamation work directly within the CMA to create dry land area is subject to a high level of statutory regulation under the New Zealand Coastal Policy Statement and the Auckland Unitary Plan. While it is considered best practice to isolate the works from the receiving environment, this can often be very difficult to achieve. Any reclamation works require early discussion with Auckland Council to ensure appropriate mitigation is in place. Reclamation work is likely to require working within the tide cycles, which creates a challenging working environment where preparation and planning are critical. The need to isolate the works area will depend on the methodology and the material being proposed in the reclamation. Options to isolate reclamation works include coffer dams and temporary bunds. If it is not possible to isolate the works, then they need to be staged around tidal cycles. It is also important to take weather conditions and sea state into account.

Materials used should be clean, washed and installed at low tide. Fine grain materials (such as clays) should be avoided. The use of binders and stabilisers must be assessed by a suitably qualified engineer to determine their strength and assess potential adverse, long-term effects. Where stabilisers or binders are used, the site should be isolated.

Where stabilising or binding products are not required, choice of the reclamation material will determine the need for a coffer dam. If the material is an erodible product, such as clays and silts (general earthworks fill), then the works area must be isolated from the coastal receiving environment with a coffer dam (Figure 134).

During any stabilising operation, contaminated water must be pumped to a secure area that will not be inundated during a storm event for treatment or removal offsite. Product transfer areas will need to be bunded and secure (i.e. such that they will not be inundated during a storm event).



Figure 134: Use of geotextiles and coastal protection rock

(SouthernSkies, 2018)

H1.4.6 Demolition of pre-existing structures

Demolition includes (but is not limited to), breaking up and removal of sea walls, foundations, jetties, pipes, and temporary structures. During any demolition activities, it is important to observe the same best practice guidance for construction works in the coastal environment as set out in Section H1.3.1.

Other considerations include:

- **Complete removal:** Where work will not cause undue negative impact, all portions of the structure (including the footing and foundations of the structures from beneath the seabed) should be removed
- **Storage:** Have bins and skips on hand to store remove demolition material
- **Tides:** Try and undertake demolition in the dry, i.e. at low tide and whenever possible, remove demolished material as it is being created
- **Debris:** Only demolish enough of the structure that can be removed from the coastal environment before the next tide
- **Isolation of materials:** Consider specifying use of either geotextile, a 'drop cloth' or similar beneath a structure being demolished to catch material before it becomes mixed with the underlying bed material
- **Barriers:** If demolished material is being temporarily stacked next to the structure as it is being demolished, also consider using geotextile as a barrier between the material and the seabed
- **Protection of water:** If the demolition work must be carried out above water, use staging structures, screens and bins to catch any falling debris
- **Silt screens and bunds:** If the conditions allow, consider using silt screens/curtains and bunds during the excavation of old footing and buried structures.

H1.4.7 Mangrove removal

Mangrove removal involves working in muddy intertidal environments and has potential to re-expose fine sediments to coastal processes. The removal of mature mangroves typically requires a consent under the Auckland Unitary Plan. Methods to minimise potential sediment re-suspension should include:

- Minimising disturbance of muddy sediments during works; including taking care when accessing and moving around sites and removing by hand where possible. Where machinery is necessary, it should be operated from the foreshore
- Ensuring the mangrove area does not include contaminated sediment, and removing any that is present
- Reinstating, or smoothing any significant seabed surface disturbance following completion of the works
- Limiting the removal of mangrove roots to just below the seabed level, leaving any subsurface roots to break down naturally.

H1.4.8 Beach replenishment

Beach replenishment involves transporting sands, gravels or cobbles to a site to increase upper foreshore and dry high-tide beach area. These works may be for coastal erosion protection, flood protection of land behind the beach and, in many cases, to increase the amenity of a beach.

To reduce sediment discharges from beach replenishment works, consider:

- **Choice of beach replenishment materials:** The material should be free of fines, impurities or foreign material. Sand density and grain size should be similar to that found at the site
- **Weather conditions:** Beach replenishment should be undertaken during calm weather
- **Tidal conditions:** Whenever possible, beach replenishment materials transported by sea should be off-loaded at high tide and retrieved/shaped as the tide falls
- **Control structures:** Any structures, such as groynes, breakwaters and revetments, should be installed prior to the beach being replenished.

Irrespective of the method used to collect the replenishment materials, it is important to consider a wide range of conditions such as how the material will be delivered, distances to final placement, access during tides, and temporary structures (such as wind fencing).

H1.4.9 Dune management works

Dune management works can include the physical reshaping (including lowering or recontouring) by heavy machinery including diggers and motor scrapers. During reshaping, debris material, contaminants and/or archaeological artefacts may be uncovered. Appropriate discovery protocols should be developed and agreed prior to works.

Any sand entering the coastal environment should be clean, deposited within the same coastal cell and not result in any adverse effects on the coastal environment (e.g. accelerated accretion, reduced quality of surf breaks etc.). An example of dune reshaping undertaken at Muriwai Beach is shown in Figure 135.

Dune management works can result in removal of native, vegetated material and/or weeds (e.g. South African Ice Plant). Therefore, works can result in an exposed, un-vegetated dune face or crest which significantly increases the potential for windblown sand. Replanting of appropriate native dune plants (e.g. spinifex and pingao) must be undertaken as soon as practicable following completion of dune management works. Planting should be done in the winter planting season in accordance with Auckland Council's dune planting guidelines.

Temporary wind fencing (e.g. brushwood fencing) may be erected during or post-works to minimise the effects of windblown sand.



Figure 135: Dune reshaping

H1.4.10 Managed realignment or retreat

Managed realignment or retreat involves the removal of coastal protection structures and moving the coastal edge landward to enable the restoration of natural coastal processes. This may involve removal of coastal defences and creating a more naturalised coastal edge, either involving coastal bank re-shaping or re-alignment and planting, or beach/dune creation. Alternatively, seawalls may be set further landward of the new coastline position as 'backstop' or buried terminal protection features.

When removing coastline armouring or re-shaping/re-aligning the coastal edge, the newly exposed coastal edge should be contained and exposure to coastal processes minimised, until the designed finish is achieved. This could involve:

- Temporary silt fences, absorbent socks, or floating booms
- Temporary bunds, or coffer dams for larger sites, or where risk of larger scale sediment release, or release of contaminants is possible
- Staging of works around appropriate tides and weather conditions.

Managed realignment or declamation should result in a coastal edge that is left in a relatively stable condition. This may include:

- Re-shaping and coastal edge planting
- Sand dune creation or enhancement, and associated dune planting
- Installation of a new seawall or engineered coastline armouring as backstop protection.

Note, in planting a newly positioned shoreline, some ongoing maintenance planting should be planned for, to ensure plant establishment and ongoing stabilisation.

Appendices



Index

Appendix A1.0	References.....	A-1
Appendix B1.0	Glossary and abbreviations	B-3
Appendix C1.0	ESC construction quality checklists	C-9
Appendix C1.1	A ‘Clean water’ or ‘dirty water’ diversion channel and bund.....	C-9
Appendix C1.2	Contour drain (cut-off).....	C-11
Appendix C1.3	Check dam.....	C-12
Appendix C1.4	Pipe drop structure and flume.....	C-14
Appendix C1.5	Stabilised entranceway	C-16
Appendix C1.6	Surface roughening	C-18
Appendix C1.7	Topsoiling and grass seeding	C-19
Appendix C1.8	Hydroseeding.....	C-21
Appendix C1.9	Turfing.....	C-22
Appendix C1.10	Mulching.....	C-23
Appendix C1.11	Geotextiles and erosion control blankets.....	C-24
Appendix C1.12	Sediment retention pond.....	C-26
Appendix C1.13	Decanting earth bund (DEB).....	C-28
Appendix C1.14	Silt fence	C-30
Appendix C1.15	Super silt fence	C-33
Appendix C1.16	Silt sock.....	C-35
Appendix C1.17	Stormwater inlet protection	C-36
Appendix C1.18	Flocculant treatment - rainfall activated shed	C-37
Appendix C1.19	Dewatering.....	C-39
Appendix C1.20	Stream diversion	C-40
Appendix D1.0	Recommended line types and symbols	D-41
Appendix E1.0	Site plan / drawing examples	E-43
Appendix F1.0	Bench testing methodology	F-46
Appendix F1.1	Step 1: Collect the soil sample.....	F-46
Appendix F1.2	Step 2: Making the soil slurry	F-47
Appendix F1.3	Step 3: Setting up the bench test jars	F-47
Appendix F1.4	Step 4: Adding sediment-laden water to bench test jars	F-48
Appendix F1.5	Step 5: Measuring test results.....	F-48
Appendix F1.6	Step 6: Interpreting test results	F-49
Appendix F1.7	Step 7: Submitting test results	F-50

Figures

Figure 136: Example of test results from bench testingF-50

Tables

Table 19: Flocculant concentrations (aluminium) for various volumes of PACF-48

Table 20: Examples of test results from bench testing.....F-49

Appendix A1.0 References

- Auckland Council. (2013). *Auckland Council Regional Plan: Coastal*. Auckland: Auckland Council. Retrieved from Auckland Council:
<http://www.aucklandcity.govt.nz/council/documents/regionalplans/coastal/aucklandregionalcoastalplanwholeplan.pdf>
- Auckland Council. (2016). *Building on small sites - Doing it right*. Auckland: Auckland Council. Retrieved from <https://www.aucklandcouncil.govt.nz/building-and-consents/understanding-building-consents-process/starting-building-renovation-work/Documents/bc5850-building-small-sites-brochure.pdf>
- Auckland Council. (2018). *Auckland Plan 2050*. Auckland: Auckland Council. Retrieved from <https://www.aucklandcouncil.govt.nz/plans-projects-policies-reports-bylaws/our-plans-strategies/auckland-plan/about-the-auckland-plan/docsprintdocuments/auckland-plan-2050-print-document.pdf>
- Auckland Council. (2019). *Auckland Unitary Plan Operative in Part - HTML PDF*. Auckland: Auckland Council. Retrieved from Auckland Council:
http://unitaryplan.aucklandcouncil.govt.nz/pages/plan/Book.aspx?exhibit=AucklandUnitaryPlan_Print
- Auckland Council. (n.d.). *Te Aranga Principles*. Retrieved from Auckland Design Manual:
http://www.aucklanddesignmanual.co.nz/design-subjects/maori-design/te_aranga_principles
- Auckland Regional Council. (1999 and 2007). *TP90 Erosion and Sediment Control Guidelines for Land Disturbing Activities in the Auckland Region*. Auckland: Auckland Regional Council.
- Auckland Regional Council. (1999). *Auckland Regional Policy Statement*. Auckland: Auckland Regional Council. Retrieved from
<http://www.aucklandcity.govt.nz/council/documents/regionalplans/aucklandcouncilregionalpolicystatement/ACRPS%20Policy.pdf>
- Auckland Regional Council. (1999). *TP108 Guidelines for stormwater runoff modelling in the Auckland Region*. Auckland: Auckland Regional Council. Retrieved from
<http://www.aucklandcity.govt.nz/council/documents/technicalpublications/TP108%20Part%20A.pdf>
- Auckland Regional Council. (2000). *TP131 Fish passage guidelines for the Auckland Region*. Auckland: Auckland Regional Council. Retrieved from
<http://www.aucklandcity.govt.nz/council/documents/technicalpublications/TP131%20Fish%20Passage%20Guidelines%20for%20the%20Auckland%20Region%202000%20Part%20A.pdf>
- Auckland Regional Council. (2001). *Regional Plan: Sediment Control*. Auckland: Auckland Regional Council.
- Auckland Regional Council. (2004). *TP227 The Use of Flocculants and Coagulants to Aid the Settlement of Suspended Sediment in Earthworks Runoff: Trials, Methodology and Design [draft]*. Auckland: Auckland Regional Council. Retrieved from
<http://www.aucklandcity.govt.nz/council/documents/technicalpublications/TP227%20The%20use%20of%20flocculants%20and%20coagulants%20to%20aid%20the%20settlement%20of%20suspended%20sediment%20in%20earthworks%20runoff%20trials%20methodology%20and%20design.pdf>

- CIRIA. (2001). *Scoping the assessment of sediment plumes from dredging*. London: C547, CIRIA.
- CIRIA; CUR; CETMEF. (2007). *The Rock Manual. The use of rock in hydraulic engineering (2nd edition)*. London: C683, CIRIA.
- Environment Canterbury. (2007). *Erosion and Sediment Control Guideline 2007 - A better way of managing earthworks and the environment*. Christchurch: Environment Canterbury.
- Lewis, M., James, J., Shaver, E., Blackbourn, S., Leahy, A., Seyb, R., . . . Coste, C. (2015). *Water sensitive design for stormwater. Auckland Council Guideline Document GD2015/004. Prepared by Boffa Miskell for Auckland Council*. Auckland: Auckland Council.
- Ministry for the Environment. (2016). *Good Practice Guide for Assessing and Managing Dust*. Wellington: Ministry for the Environment. Retrieved from <https://www.mfe.govt.nz/sites/default/files/media/Air/good-practice-guide-dust-2016.pdf>
- New Zealand Department of Conservation. (2010). *New Zealand Coastal Policy Statement 2010*. Wellington: New Zealand Department of Conservation.
- New Zealand Government. (2011). *Resource Management (National Environmental Standard for Assessing and Managing Contaminants in Soil to Protect Human Health) Regulations 2011*. Wellington: New Zealand Government. Retrieved from New Zealand Legislation: <http://www.legislation.govt.nz/regulation/public/2011/0361/latest/DLM4052228.html>
- New Zealand Government. (2018). *Hauraki Gulf Marine Park Act 2000*. Wellington: New Zealand Government. Retrieved from New Zealand Legislation: <http://www.legislation.govt.nz/act/public/2000/0001/latest/DLM52558.html>
- New Zealand Government. (2018). *Health and Safety at Work Act 2015*. Wellington: New Zealand Government. Retrieved from New Zealand Legislation: <http://www.legislation.govt.nz/act/public/2015/0070/55.0/DLM5976660.html>
- New Zealand Government. (2018). *Resource Management Act 1991*. Wellington: New Zealand Government. Retrieved from New Zealand Legislation: <http://www.legislation.govt.nz/act/public/1991/0069/232.0/DLM230265.html>
- New Zealand Transport Agency. (2014). *Erosion and Sediment Control Guidelines for State Highway Infrastructure*. Wellington: New Zealand Transport Agency.
- Pearce, P., Bell, R., Bostock, H., Carey-Smith, T., Collins, D., Fedaeff, N., . . . Woolley, J.-M. (2017). *Auckland Region climate change projections and impacts. Prepared by the National Institute of Water and Atmospheric Research, NIWA, for Auckland Council. Auckland Council Technical Report, TR2017/030*. Auckland: NIWA. Retrieved from <http://www.knowledgeauckland.org.nz/assets/publications/TR2017-030-Auckland-region-climate-change-projections-and-impacts.pdf>
- US Army Corps of Engineers. (2002). *Coastal Engineering Manual. Engineer Manual 1110-2-1100*. Washington, D.C.: US Army Corps of Engineers.

Appendix B1.0 Glossary and abbreviations

Term/abbreviation/ acronym	Description
m ²	Metre square
m ³	Cubic metre
<	Less than
>	Greater than
%	Percentage
ACDP	Auckland Council District Plan
Anti-seep collar	A projecting collar built around the outside of a pipe, tunnel, or conduit under or through an embankment dam to lengthen the seep path along the outer surface of the conduit.
ARPS	Auckland Council Regional Policy Statement (1999)
AEP	Annual exceedance probability
ASTM	American Society for Testing and Materials
Batch dosing	Application of flocculant (during flocculant treatment) in a single dose, rather than through a continuous flow proportional dosing system).
Check dam	A small, often temporary, dam constructed across a swale, drainage ditch, or waterway to counteract erosion by reducing water flow velocity.
Flocculant treatment	A sediment control practice that involves the addition of reagents to sediment-laden runoff to increase the rate of settlement of fine soil particles. Flocculant treatment relies on two basic processes: 'coagulation' and 'flocculation'.
Clean water	Water runoff that is free of sediment or pollutants. In an ESC context this usually refers to water from above a work site that has not run through the works area.
CMA	Coastal marine area
Coagulation	Coagulation is an important process for flocculant treatment. It is most effective where soils have a high proportion of colloidal particles. These particles typically have a negative electrostatic surface charge. These 'like charged' particles tend to repel each other, preventing coagulated particles from forming, such that the particles remain in suspension. By adding a reagent that develops positive charges the colloidal material is destabilised, allowing the particles to clump together (coagulate) forming larger heavier particles.
Coffer dam diversion	Partial diversion of a watercourse through use of non-erodible materials such as sand bags, sheet piles or similar, to allow for the construction of outfall structures or stream bank retaining works. In these situations, a coffer dam is used to create a dry working environment to complete the works.

Term/abbreviation/ acronym	Description
Contour drain (cutoff)	Temporary excavated channels or ridges, or a combination of both, that are constructed slightly off the slope contour. The purpose of a contour drain is to break overland flow that is draining down disturbed slopes, by reducing the slope length, and thereby reducing the erosive power of runoff. The drain also diverts sediment-laden water to appropriate controls via stable outlets.
CPTED	Crime Prevention Through Environmental Design
CTMP	Chemical Treatment Management Plan
Dam and pump or dam and divert devices	Temporary practices used to convey surface water from above a construction activity downstream of that activity. These diversion methodologies will assist in providing dry working conditions for culvert installation. Damming a stream and pumping the flows around the worksite back to the stream considerably minimises disturbance relative to constructing a new diversion channel.
Decanting earth bund (DEB)	An impoundment area formed from a temporary bund or ridge of compacted earth. The bund provides an area where ponding of runoff can occur, and suspended material can settle out before runoff is discharged.
Dewatering	The removal of water from excavations, tunnelling, trenches and sediment control devices. Dewatering may be the removal of either surface water or groundwater that has collected.
Dirty water	Sediment-laden runoff. In an ESC context this usually refers to water that has run through a works' area. This water requires treatment prior to discharge.
Diversion channels and bunds	A non-erodible channel and/or bund for the conveyance of clean or dirty water runoff that is constructed for a specific design storm.
Earthworks	The disturbance of soil, earth or substrate land surfaces for activities such as residential, commercial or infrastructure developments and maintenance, roads and utilities, and earthworks associated with quarrying, such as overburden disposal.
Erodibility (of soils)	The susceptibility of soil particles to become detached by erosive forces.
Erosion	The process whereby the land surface is worn away through physical, chemical or biological processes resulting in detachment and transport of soil particles. For different types of erosion see definitions in Table 1 (Part 1).
Erosion control blankets	Proprietary rolled erosion control products, commonly made from biodegradable materials. They provide an instant, short to medium-term protective cover of the soil surface, shielding it from the erosive forces of wind, raindrop impact and sheet flows, until a vegetative cover can be established, or an alternative stabilisation methodology is used.
ESC	Erosion and sediment control
Filter sock	See 'silt sock'
Flocculant	A reagent that promotes flocculation by causing colloids and other suspended particles in liquids to aggregate, forming a floc. Flocculants are used in water treatment processes to improve the sedimentation or filterability of small particles.
Flocculation	A type of treatment where 'flocculant' is used to enable the sediment particles join together to form 'flocs', or larger, heavier particles that settle more rapidly.
FMP	Flocculation Management Plan

Term/abbreviation/ acronym	Description
Floc sock flocculant treatment	A type of flocculant treatment that is achieved by placing a segmented geosynthetic sock filled with a dry flake form of a reagent in the dirty water diversion channel, so that dirty water runoff will flow over the floc sock, dissolving and mixing with the reagent.
Flume	See 'pipe drop structure'
Geotextile	Permeable fabric which, when used in association with soil, has the ability to stabilise and protect.
GLEAMS	Groundwater Loading Effects of Agricultural Management Systems
Grass seeding	The planting and establishment of quick growing and/or perennial grass to provide temporary and/or permanent stabilisation on exposed areas. The practice is often undertaken in conjunction with the placement of topsoil.
Ha	Hectare
HGMPA	Hauraki Gulf Marine Park Act 2000
Hotmix	A type of asphalt concrete produced by heating the asphalt binder to decrease its viscosity, and drying the aggregate to remove moisture from it prior to mixing.
Hotmix diversion bund	A bund constructed of Hotmix directly on the impervious surface. These are often a replacement for a removed kerb and channel.
HSE Act	Health and Safety in Employment Act 1992
HSNO Act	Hazardous Substances and New Organisms Act 1996
HT	High tensile
Hydroseeding	The application of seed, fertiliser and paper or wood pulp with water in the form of a slurry, which is sprayed over an area to provide for re-vegetation.
Kg	Kilogram
Land-disturbing activities	Defined in the Proposed Auckland Unitary Plan (PAUP, 2013) to include 'earthworks', 'ancillary farming earthworks' and 'ancillary forestry earthworks.'
m	Metre
MHWS	Mean high water spring
mm	Millimetre
MSDS	Material safety data sheet
Mulching	A soil stabilisation practice that involves the application of a protective layer of straw or other suitable material to the soil surface.
NES:CS	National Environmental Standard for assessing and managing contaminants in soil to protect human health.
NIWA	National Institute of Water and Atmospheric Research
N:P:K	The ratio of nitrogen, phosphorus, and potassium in soil or fertiliser.
NZCPS	New Zealand Coastal Policy Statement (2010)

Term/abbreviation/ acronym	Description
PAC	Polyaluminium chloride
PAUP	Proposed Auckland Unitary Plan (2013)
Permeability (of soils)	The ability of a soil to allow air and water to move through the soil.
Pipe drop structure	A temporary pipe structure or constructed flume placed from the top of a slope to the bottom of a slope. The structure is designed to convey a concentrated flow of either clean or dirty surface runoff down a slope without causing erosion.
Porosity (of soils)	The fraction of the total soil volume that is taken up by pore space.
PPE	Personal protective equipment
Rainfall activated flocculant treatment	Also called 'rainfall activated dosing'. This is an option for treatment (by flocculation) of sediment-laden runoff. It provides an appropriate level of dosage based on the rainfall volume and intensity.
Rip-rap	A layer of large stones used to protect soil/shorelines from erosion in areas of concentrated runoff or scour.
RMA	Resource Management Act 1991
Runoff	Surface water runoff (also known as overland flow) is the flow of water that occurs when excess stormwater, meltwater, or other sources flows over the earth's surface.
Runon	Surface water flow (overland flow) into a site.
Sedimentation	The deposition of eroded soil.
Sediment retention pond (SRP)	A temporary pond formed by excavation into natural ground, or by the construction of an embankment, which is used to detain runoff flows so that deposition of transported sediment can occur through settlement. SRPs incorporate an outlet device to dewater the pond at a rate that allows a high percentage of suspended sediment to settle out.
Sediment yield	The amount of sediment discharged from a catchment reaching or passing a point of interest in a given period of time. Sediment yield estimates are normally given as tonnes per year or kilograms per year.
Sensitive receiving environment	An area where wastewater, stormwater or other discharges have the potential to have adverse impacts on important natural or human uses or values in marine, freshwater, and terrestrial environments
SiD	Safety in Design
Silt fence	A temporary barrier of woven geotextile fabric that is used to capture mainly coarse sediments carried in sheet flow. Silt fences temporarily impound sediment-laden runoff, slowing down the flow rate and allowing sediment to settle out of the water.
Silt sock	A tubular stormwater sediment control and filtration device, consisting of a mesh tube filled with a filter material (e.g. compost, sawdust, wood bark, straw) used to intercept and filter runoff. They are also referred to as 'filter socks'.
SBMP	Soil Binder Management Plan
Soil ameliorants	Substances that are added to soil to aid plant growth.
Soil binders	Soil-stabilising agents (also known as polymers).
SSMP	Site Specific Safety Management Plan

Term/abbreviation/ acronym	Description
Stabilised entrance	Stabilised areas located at any entry or exit point of a construction site. These are stabilised through measures such as shaker ramps, or large rocks and are designed to prevent site access points becoming sources of sediment, and/or assist in minimising dust generation and disturbance of areas adjacent to the road frontage by providing a defined entry and exit point.
Stormwater inlet protection	A sediment control practice that involves construction of a barrier across or around a catchpit or other stormwater inlet. The protection may take various forms depending upon the type of inlet to be protected.
Super silt fence	A temporary barrier of woven geotextile fabric over a chain link fence that is used to capture predominantly coarse sediments carried in sheet flows. Super silt fences temporarily impound sediment-laden runoff, reduce velocities and allow sediment to settle out of the water. The use of super silt fences is similar to that of silt fences. However, super silt fences are a more robust device that is appropriate to control runoff from steeper or larger catchments than silt fences.
Surface roughening	The practice of roughening the surface of unstabilised (bare soil) earth surface; either with horizontal grooves across the slope, or by tracking with construction equipment.
T-bar	A floating dewatering device that allows for the decanting of the cleaner surface water from the top of the water column.
Temporary watercourse crossings	Temporary culverts or bridge structures installed across a watercourse for short-term use by construction vehicles. They provide a means for construction vehicles to cross watercourses without moving sediment into the watercourse or directly affecting the streambed, generally while the new permanent crossing is installed.
Topsoiling	A soil stabilisation practice that comprises the addition of topsoil to provide a suitable soil medium for vegetative growth for erosion control, while providing some protection of the subsoil layer and also increasing the absorption capacity of the soil.
Treatment train	The use of a range of practices, operating in series and linked to improve the overall efficiency of contaminant removal. In the context of ESC, this means that a series of ESC measures are planned to link functionally to form a treatment train. Each measure has a specific role within the framework of ESC. This approach can be a combination of structural (e.g. sediment retention ponds, perimeter controls) and non-structural (e.g. earthwork season) practices.
Turfig	A soil stabilisation practice that involves the establishment and permanent stabilisation of disturbed areas by laying a continuous cover of grass turf.
USLE	Universal Soil Loss Equation
WSD	Water sensitive design

Appendix C1.0 ESC construction quality checklists

Appendix C1.1 A ‘Clean water’ or ‘dirty water’ diversion channel and bund

Contractor:	Date: Time:	Consent #:	Site:
-------------	----------------	------------	-------

Construction checklist (refer Figures over page and Section E2.1 and E2.2 of GD05 for further details)	Yes ✓	No (X) (add comments to explain)
Route avoids trees, services, fence lines or other natural or built features		
Channels are trapezoidal or parabolic in shape		
Internal side slopes are no steeper than 3:1 External side slopes are no steeper than 2:1		
Drains are constructed with a uniform grade along the invert (as sudden decreases may cause sediment to accumulate causing the bank to overtop)		
Bunds are well compacted		
Outlets are stable and protected as needed		
Diversions are stabilised to prevent erosion		
In some instances this may require specific geotechnical design to ensure the stability and integrity of the structure		

Note: The purpose of this checklist is for contractors to complete on-site self-checks of construction quality for ESC practices. This is not a compliance or as-built checklist.

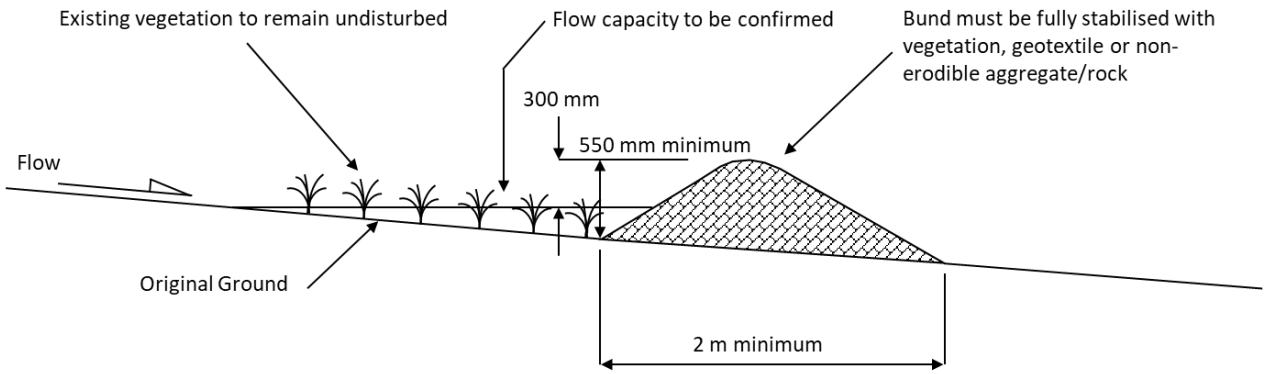

Cross Section

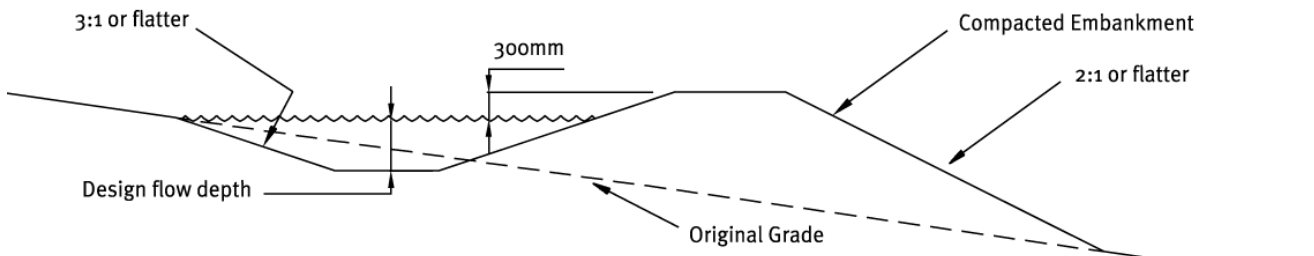

Cross Section

Appendix C1.2 Contour drain (cut-off)

Contractor:	Date: Time:	Consent #:	Site:
-------------	----------------	------------	-------

Construction checklist (refer Figures below and Section E2.3 of GD05 for further details)	Yes (✓)	No (X) (Add comments to explain)
Minimum compacted height is 250 mm		
Minimum total depth is 500 mm		
Longitudinal grade is < 2% (unless lined)		
Catchment area is < 0.5 ha		
Flow are is parabolic and not V-shaped		
Drains are as short as possible		
Earth windrows and banks are compacted		
Temporary contour drains are constructed across unprotected slopes at the end of the day's work and/or before forecast rain		

Note: The purpose of this checklist is for contractors to complete on-site self-checks of construction quality for ESC practices. This is not a compliance or as-built checklist.

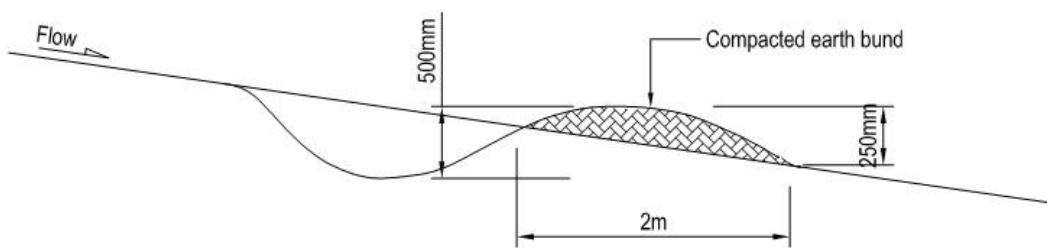

Cross - section

Appendix C1.3 Check dam

Contractor:	Date: Time:	Consent #:	Site:
-------------	----------------	------------	-------

Construction checklist (refer Figures below and Section E2.4 of GD05 for further details)	Yes ✓	No (X) (Add comments to explain)
Fabric used for sandbags is UV resistant		
Dams are spaced so the toe of an upstream dam is at approximately the same elevation as the centre height (spillway level) of the downstream dam		
Centre of the check dam is 150-200 mm lower than the outside edges to create a spillway		
Toes of the fabric dams extend >1 m up-slope and are buried in a 300 mm deep trench		
Geotextile fabric beneath check dams, if constructed on erodible soils		

Note: The purpose of this checklist is for contractors to complete on-site self-checks of construction quality for ESC practices. This is not a compliance or as-built checklist.



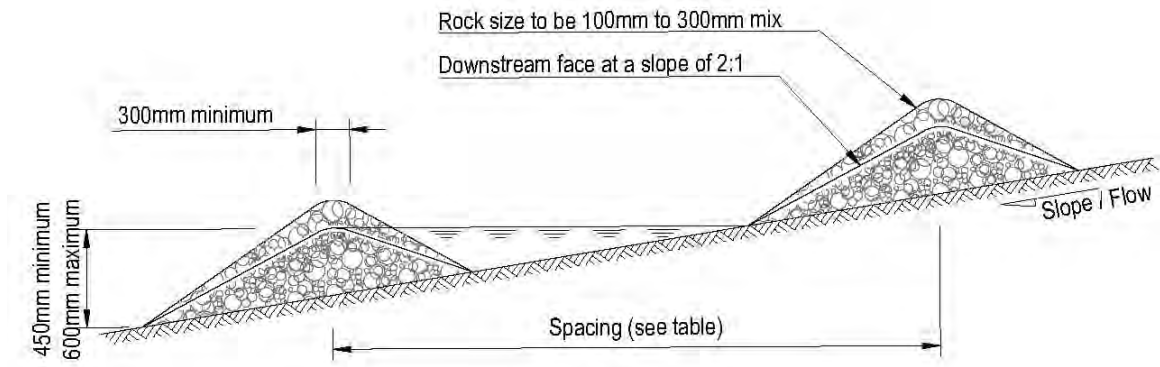

Elevation

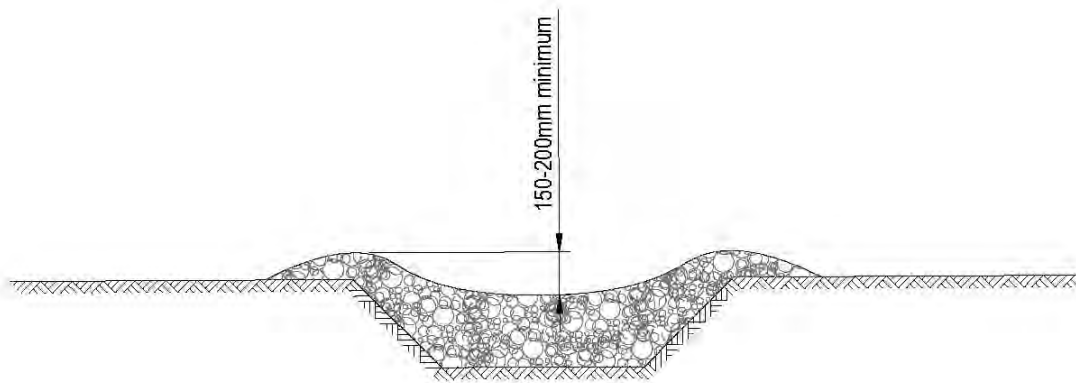

Cross - section

Slope of site (%)	Spacing (m) between dams with a 450 mm centre height	Spacing (m) between dams with a 600 mm centre height
Less than 2%	24	30
2 – 4%	12	15
4 – 7%	8	11
7 – 10%	5	6
>10%	Unsuitable – use stabilised channel or specific engineered design	Unsuitable – use stabilised channel or specific engineered design

Appendix C1.4 Pipe drop structure and flume

Contractor:	Date: Time:	Consent #:	Site:
-------------	----------------	------------	-------

Construction checklist (refer figures below and Section E2.5 of GD05 for further details)	Yes (✓)	No (X) (Add comments to explain)
Use when slopes > 3:1		
Do not use on slopes < 5:1		
Device is constructed of an impervious material		
Upstream diversion channel or bund is 2 x height of flume or pipe		
A stabilised entry apron is installed to prevent scour or piping		
The device extends beyond the toe of the slope with erosion protection at the outfall		
Rigid or flexible pipe material has been used (where pipe used)		
Structure is pinned/secured to the slope every 4 m		
Connections are water tight		

Note: The purpose of this checklist is for contractors to complete on-site self-checks of construction quality for ESC practices. This is not a compliance or as-built checklist.

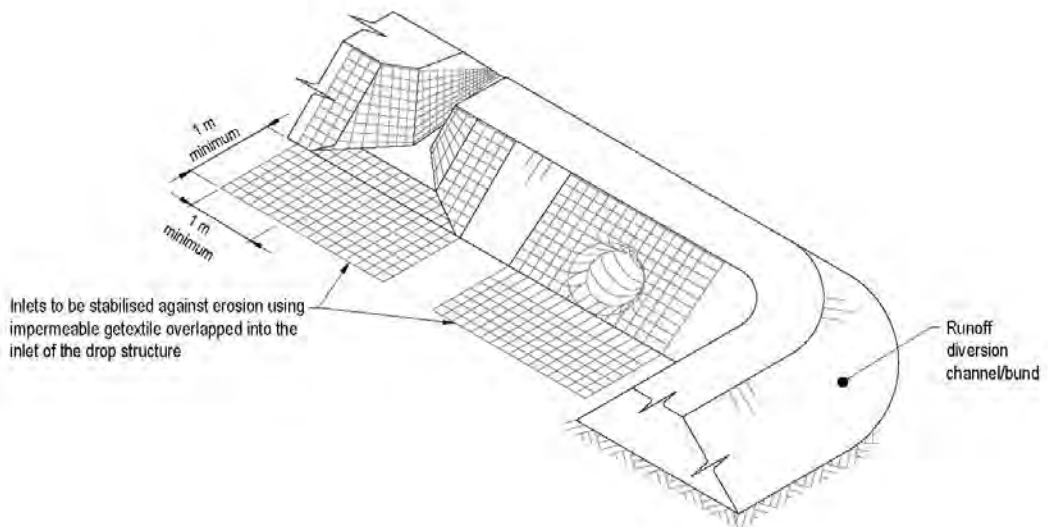
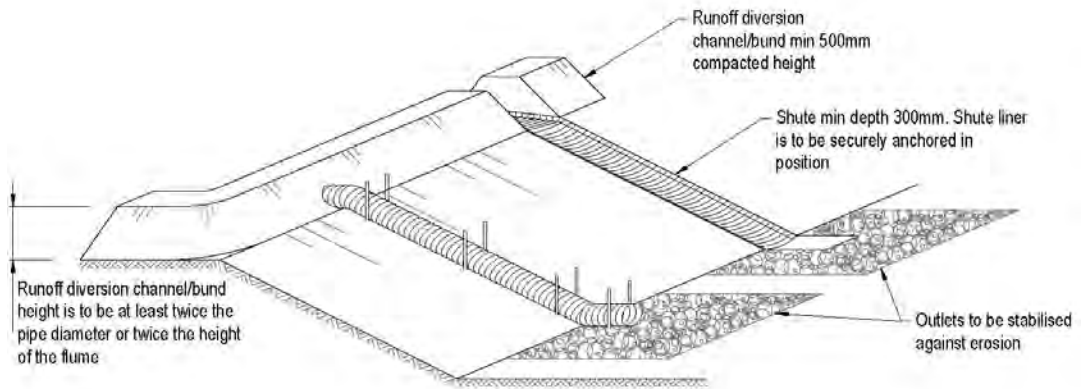

Appendix C1.5 Stabilised entranceway

Contractor:	Date: Time:	Consent #:	Site:
-------------	----------------	------------	-------

Construction checklist (refer figures below and Section E2.6 of GD05 for further details)	Yes (✓)	No (X) (Add comments to explain)
Area has been cleared of unsuitable material and smooth graded		
Woven geotextile has been placed over the area, and is properly pinned and overlapped, as necessary		
At least 10 m of aggregate has been placed (extending from site boundary), 4 m wide and minimum 150 mm deep, using 50-150 mm washed aggregate		
Vehicles cannot bypass the entranceway		

Note: The purpose of this checklist is for contractors to complete on-site self-checks of construction quality for ESC practices. This is not a compliance or as-built checklist.



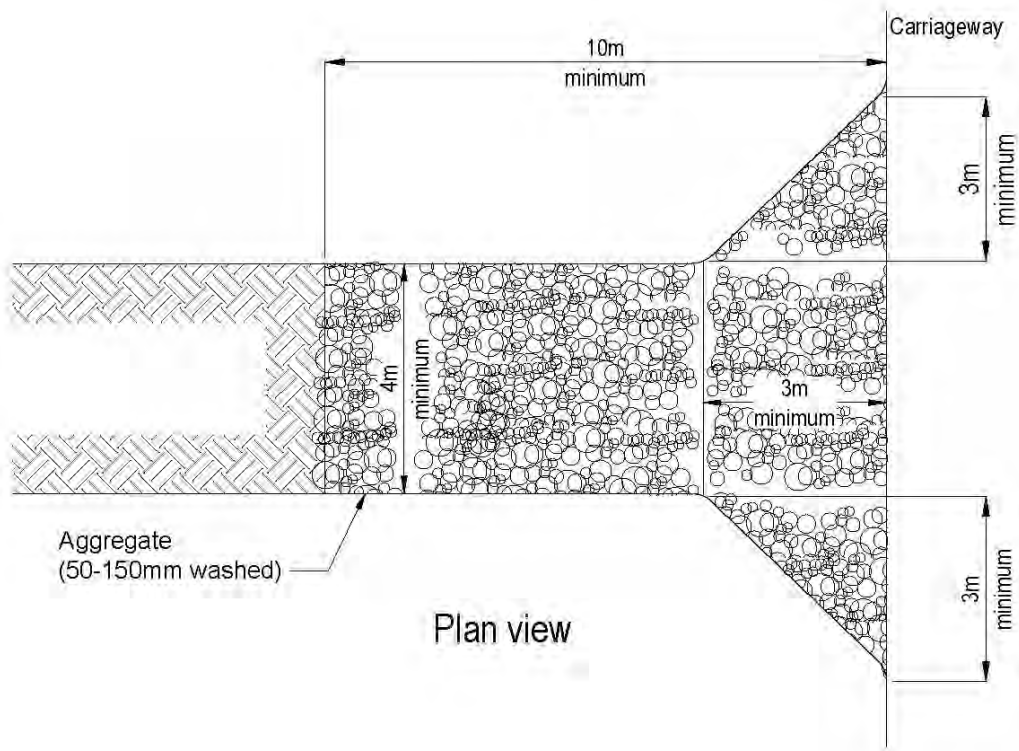
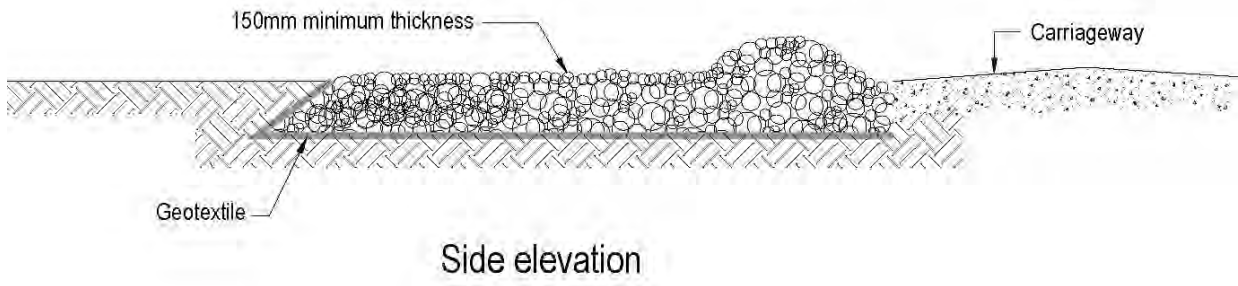

Appendix C1.6 Surface roughening

Contractor:	Date: Time:	Consent #:	Site:
-------------	----------------	------------	-------

Construction checklist (refer figures below and Section E2.7 of GD05 for further details)	Yes (✓)	No (X) (Add comments to explain)
Water is diverted away from the slope face prior to slope roughening		
Existing rills are filled before roughening		
Roughening is undertaken perpendicular to surface water flows		
When track-walking topsoil material, care is taken not to compact the slope		
For track-walking, well-defined cleat impressions are made in the soil, parallel to the contour or perpendicular to the slope		

Note: The purpose of this checklist is for contractors to complete on-site self-checks of construction quality for ESC practices. This is not a compliance or as-built checklist.

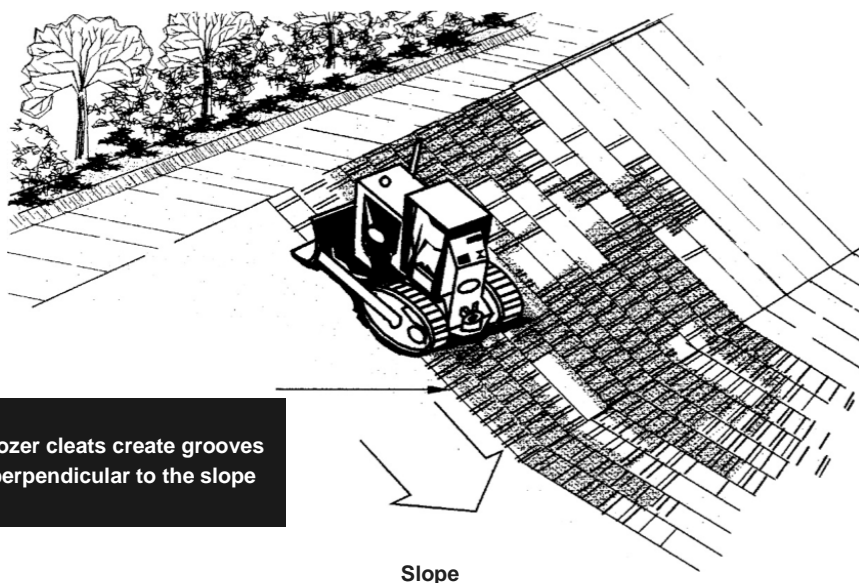

Appendix C1.7 Topsoiling and grass seeding

Contractor:	Date: Time:	Consent #:	Site:
-------------	----------------	------------	-------

Construction checklist (refer figures below and Section E3.1 of GD05 for further details)	Yes (✓)	No (X) (Add comments to explain)
Water is diverted away from the slope face prior to slope roughening		
A good seed bed has been prepared, which is loose, uniform and free of large clods		
The soil surface is not compacted		
Greater than 100 mm of topsoil has been applied		
Fertiliser has been applied according to manufacturer's recommendations or following the guidelines in the Table below		
Seed has been applied uniformly at the required rate (see Table below)		
Site conditions and time of year are appropriate for germination. As outlined in Section E3.4 of GD05, mulching has been undertaken in conjunction with the seeding programme during dry or cold periods		
Adequate watering has been provided		
Grass strike ensures site coverage is > 80%		

Note: The purpose of this checklist is for contractors to complete on-site self-checks of construction quality for ESC practices. This is not a compliance or as-built checklist.

Typical seed and fertiliser application rates

	Typical seed mix ¹	Application rate
Temporary seeding	Annual Ryegrass	100-250 kg/ha
Permanent seeding	Perennial Ryegrass – 70% Fescues/Cocksfoot – 20% Clover/Lotus – 5% Browntop – 5%	200-400 kg/ha
Fertiliser application	N:P:K (15:10:10)	200-800 kg/ha
Maintenance fertiliser	N:P:K (15:10:10) and Urea	As required

Note 1: In all circumstances ensure that the seed and fertiliser application rates and mix is appropriate for your site. Always discuss with your seed and fertiliser supplier prior to utilisation.



Appendix C1.8 Hydroseeding

Contractor:	Date: Time:	Consent #:	Site:
-------------	----------------	------------	-------

Construction checklist (refer Section E3.2 of GD05 for further details)	Yes (✓)	No (X) (Add comments to explain)
A hydroseeding contractor has been consulted to ensure correct application, and the manufacturer's recommendations have been followed		
Adequate watering has been provided		
Grass strike ensures site coverage is > 80%		

Note: The purpose of this checklist is for contractors to complete on-site self-checks of construction quality for ESC practices. This is not a compliance or as-built checklist.



Appendix C1.9 Turfing

Contractor:	Date: Time:	Consent #:	Site:
-------------	----------------	------------	-------

Construction checklist (refer Section E3.3 of GD05 for further details)	Yes (✓)	No (X) (Add comments to explain)
A good base has been prepared, which is loose, uniform and free of large clods and other objectionable material		
If turfing is placed during periods of high temperature, it is irrigated immediately prior		
Turf has been laid on the contour, starting at the bottom and working up slope; never up and down the slope		
Joints are butted tightly and do not stretch or overlap		
For slopes steeper than 3:1, turf has been secured to ground with pegs or other means		
Turf has been rolled and tamped immediately to ensure solid contact with ground		
Adequate watering is provided		

Note: The purpose of this checklist is for contractors to complete on-site self-checks of construction quality for ESC practices. This is not a compliance or as-built checklist.



Appendix C1.10 Mulching

Contractor:	Date: Time:	Consent #:	Site:
-------------	----------------	------------	-------

Construction checklist (refer Section E3.4 of GD05 for further details)	Yes (✓)	No (X) (Add comments to explain)
Straw or hay mulch is unrotted material and has been applied at a rate that provides a completed cover of the soil surface. This is typically in the order 4,000-6,000 kg/ha. Mulch material is relatively free of weeds and does not contain noxious weed species. A list of noxious weeds can be obtained from Auckland Council		
If wind is a problem, mulch is either crimped or bound to prevent blowing		
Hydro mulch contains a minimum of 80% virgin or recycled wood and has been applied in accordance with the manufacturer’s specifications. The application rate will range from 2,200 kg/ha – 2,800 kg/ha depending on the slope gradient. The coverage should not exceed slope length < 150 m		
Wood chip is applied at rates of 10,000 kg/ha – 13,000 kg/ha		
If stockpiling woodchips on site, stockpiles are turned every so often to reduce the risk of heating		

Note: The purpose of this checklist is for contractors to complete on-site self-checks of construction quality for ESC practices. This is not a compliance or as-built checklist.



Appendix C1.11 Geotextiles and erosion control blankets

Contractor:	Date: Time:	Consent #:	Site:
-------------	----------------	------------	-------

Construction checklist (refer figure over page and Section E3.5 of GD05 for further details)	Yes (✓)	No (X) (Add comments to explain)
Site is prepared to ensure complete contact of the blanket or matting with the soil		
Area is graded and shaped for installation		
All rocks, clods, vegetation or other obstructions are removed		
Seedbed is prepared by loosening 50 mm to 75 mm of topsoil		
Area is seeded prior to blanket installation unless specified otherwise		
Wire staples, stake pins or wooden stakes have been placed to anchor mats and blankets to the ground. Proper sized anchoring materials have been used		
On slopes, the blanket was started at the top of the slope and rolled down-slope		
Blanket edges are overlapped		
In channels, there is an anchor trench >150 mm deep x 150 mm across at the lower end of the project		
Intermittent check slots are installed at 8-10 m intervals		
Side fabric edges are keyed in at least 100 mm deep x 100 mm wide		
Channel fabric has been started at the downstream end with upstream geotextile overlapping < 75 mm		
Upstream end has been keyed in >300 mm x 150 mm wide		
Turf reinforcement matting has been seeded and filled with soil if specified		

Note: The purpose of this checklist is for contractors to complete on-site self-checks of construction quality for ESC practices. This is not a compliance or as-built checklist.

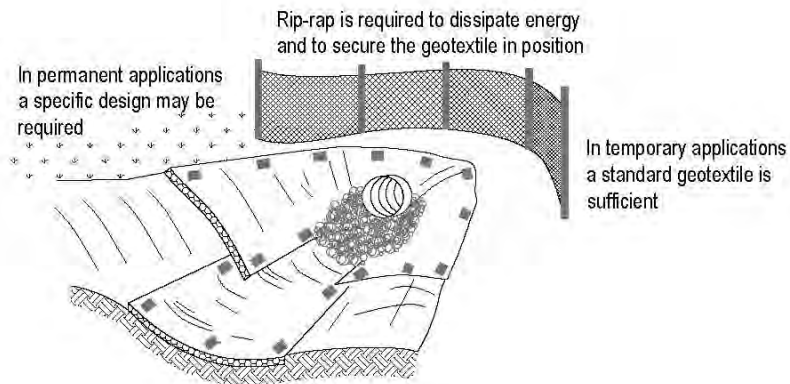
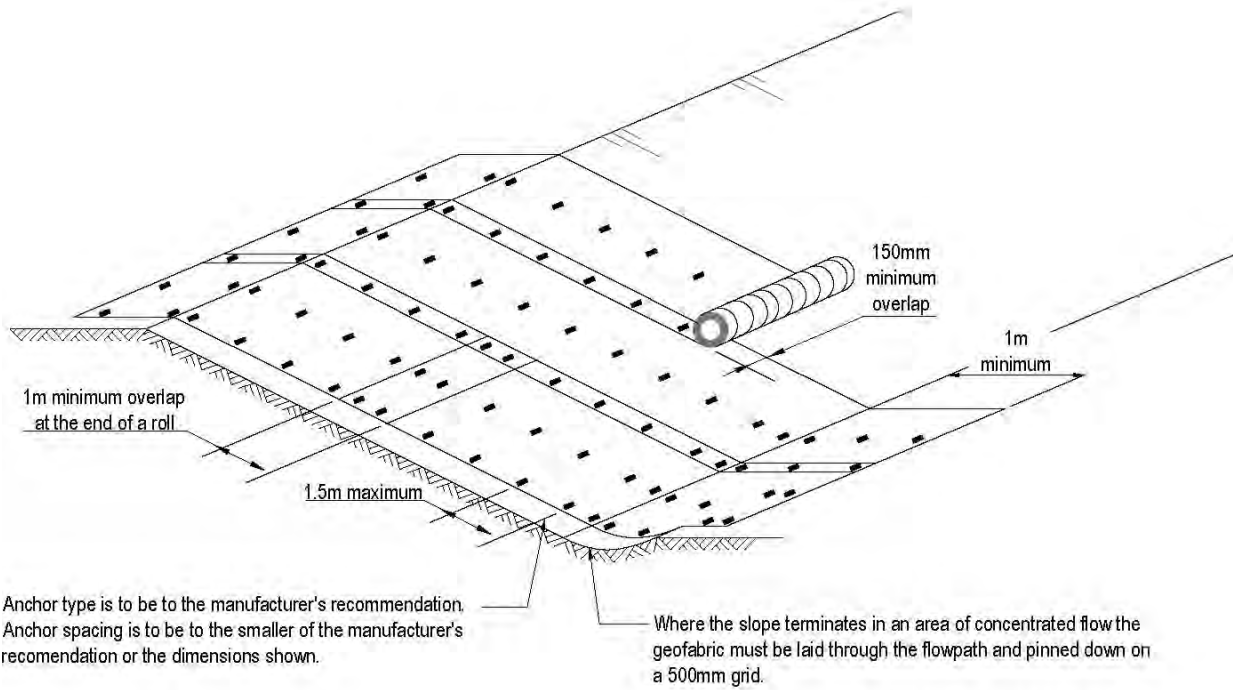

Appendix C1.12 Sediment retention pond

Contractor:	Date: Time:	Consent #:	Site:
-------------	----------------	------------	-------

Construction checklist (refer figure over page and Section F1.1 of GD05 for further details)	Yes (✓)	No (X) (Add comments to explain)
Sediment control has been implemented down-slope of the proposed sediment retention pond		
Areas are cleared of proposed fill or topsoil or other suitable material down to competent material		
Only approved fill material has been used		
Fill has been placed and compacted in layers as per the engineering recommendations, and appropriate testing has been undertaken to confirm compliance		
Fill embankment has been constructed 10% higher than the design height to allow for settlement		
Pipework and anti-seep collars or filter collars have been installed during construction of the embankment, with good compaction around pipes		
The emergency spillway has been constructed as per instructions in Section F1.1.2 of GD05		
A level spreader has been installed and stabilised		
The decant and pulley system is securely attached to the horizontal pipework, with all connections watertight. Manhole risers have been placed on a firm foundation of concrete or compacted soil		
Inlets and outlets are protected with fabric		
Baffles are installed when the pond's length to width ratio < 3:1		
An all-weather access track is provided for maintenance		
All elevations have been checked to ensure proper function and rectify any inaccuracies		
Both internal and external batters and the emergency spillway have been stabilised in accordance with the approved erosion and sediment control plan		
An as-built assessment has been undertaken at the completion of construction and any discrepancies with the design rectified		

Note: The purpose of this checklist is for contractors to complete on-site self-checks of construction quality for ESC practices. This is not a compliance or as-built checklist.

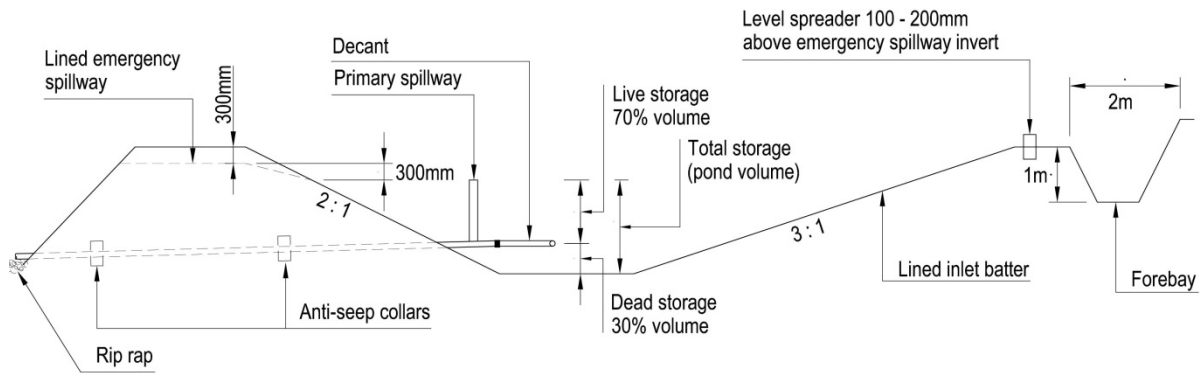
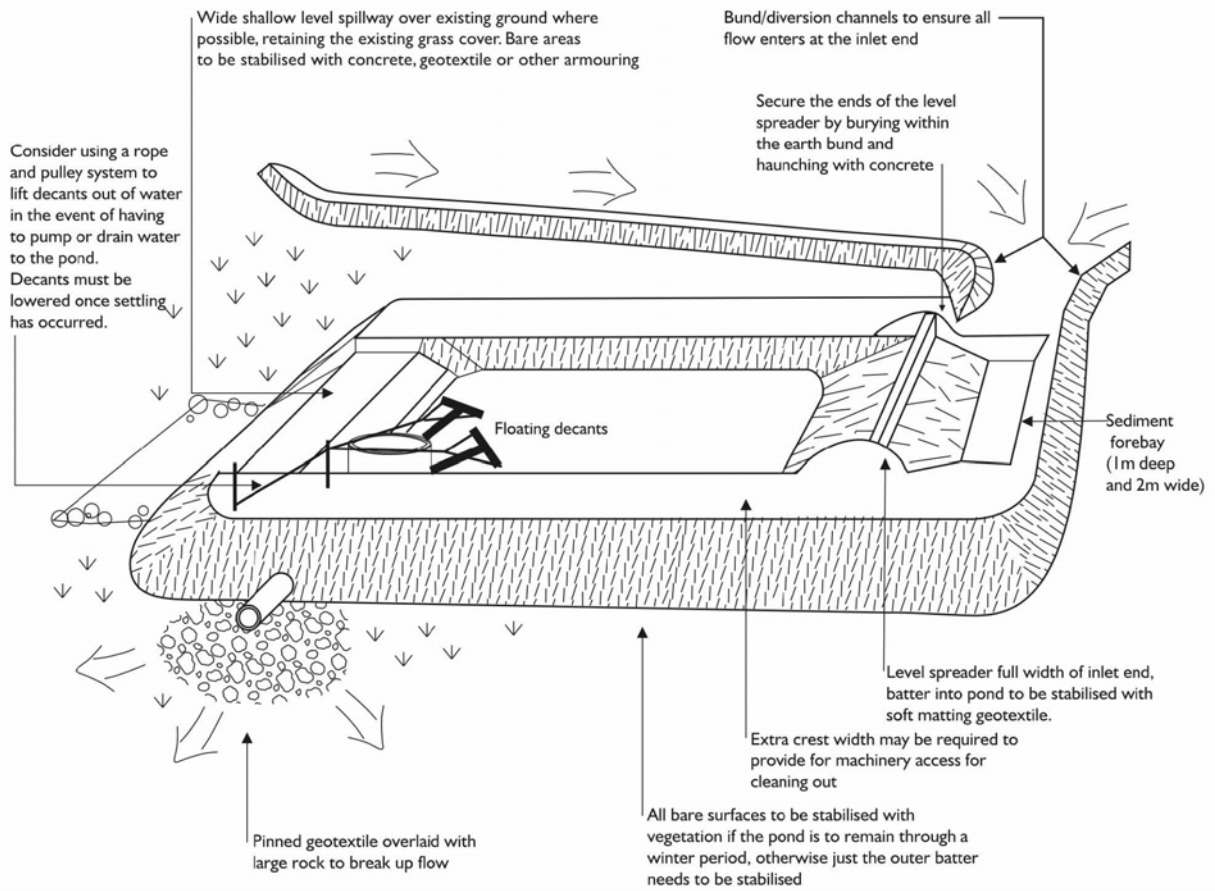

SRP cross - section

Appendix C1.13 Decanting earth bund (DEB)

Contractor:	Date: Time:	Consent #:	Site:
-------------	----------------	------------	-------

Construction checklist (refer Figures over page and Section F1.2 of GD05 for further details)	Yes (✓)	No (X) (Add comments to explain)
DEB has been built along the contour to obtain the required volumes		
All organic/ vegetation is removed before construction		
The DEB is keyed into the existing ground to a minimum depth of 0.3 m		
The DEB is built with a clay-silt mix of suitable moisture content to achieve a reasonable compaction standard (90%). This can be achieved, in most instances, by track rolling at 150 – 200 mm lifts. Particular care is required to achieve good compaction around the outlet pipe that passes through the bund to avoid seepage and potential failure		
A 150 mm diameter non-perforated outlet pipe has been installed through the bund and discharges to a stable erosion proofed area or stormwater system		
A T-Bar decant has been attached by way of a standard joint (glued and screwed). The decant is 100 or 150 mm dia. PVC pipe, 0.5 m long with equally spaced holes of 10 mm diameter and fixed firmly to a waratah standard to achieve 0.3 litres/ second/1,000 m ² of contributing catchment		
A sealed PVC pipe (with endcaps) has been placed on top of the decant to provide buoyancy		
A flexible thick rubber coupling has been used to provide a connection between the decant arm and the discharge pipe. The flexible coupling has been fastened using strap clamps, glue and screws		
The decant is fastened to two waratahs by way of a nylon cord to the correct height		

Construction checklist (refer Figures over page and Section F1.2 of GD05 for further details)	Yes (✓)	No (X) (Add comments to explain)
An emergency spillway has been provided to a stabilised outfall 100 mm freeboard height above the primary spillway. This can be a trapezoidal spillway with a minimum invert length of 2 m that is smooth, has no voids and is lined with a soft needle punched geotextile to the stabilised outfall. The geotextile is pinned at 0.5 m centres		
The emergency spillway has a minimum freeboard of 250 mm, i.e. between the invert of the spillway to the lowest point of the top of the bund		
An as-built assessment has been completed at the completion of construction to check against the design. Any discrepancies have been rectified.		

Note: The purpose of this checklist is for contractors to complete on-site self-checks of construction quality for ESC practices. This is not a compliance or as-built checklist.

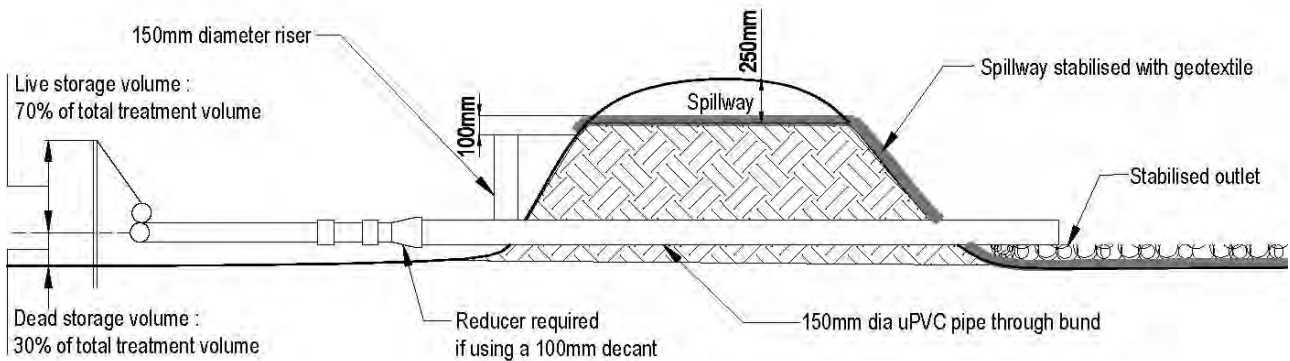

Cross - section



Appendix C1.14 Silt fence

Contractor:	Date: Time:	Consent #:	Site:
-------------	----------------	------------	-------

Construction checklist (refer Table and Figure over page and Section F1.3 of GD05 for further details)	Yes (✓)	No (X) (Add comments to explain)
The silt fence material used is appropriate to the site conditions and in accordance with the manufacturer's specifications		
Silt fences have been installed along the contour		
A trench of a minimum of 100 mm wide and 200 mm deep has been excavated along the proposed line of the silt fence		
Supporting posts /steel waratahs are installed at least 1.5 m length and 2-4 m apart		
Support posts/waratahs are installed on the down-slope edge of the trench, with silt fence fabric on the up-slope side of the support posts to the full depth of the trench. The trench is backfilled with compacted soil		
The top of the silt fence fabric is reinforced with a support made of high tensile 2.5 mm diameter galvanised wire. The wire is tensioned using permanent wire strainers attached to angled waratahs at the end of the silt fence		
The silt fence fabric is doubled over and fastened to the wire with silt fence clips at 500 mm spacings		
Where ends of the silt fence fabric come together, they are overlapped, folded and stapled/screwed to prevent sediment bypass		

Note: The purpose of this checklist is for contractors to complete on-site self-checks of construction quality for ESC practices. This is not a compliance or as-built checklist.

Slope steepness %	Slope length (m) (maximum)	Spacing of returns (m)	Silt fence length (m) (maximum)
Flatter than 2%	Unlimited	N/A	Unlimited
2 – 10%	40	60	300
10 – 20%	30	50	230
20 – 33%	20	40	150
33 – 50%	15	30	75
> 50%	6	20	40

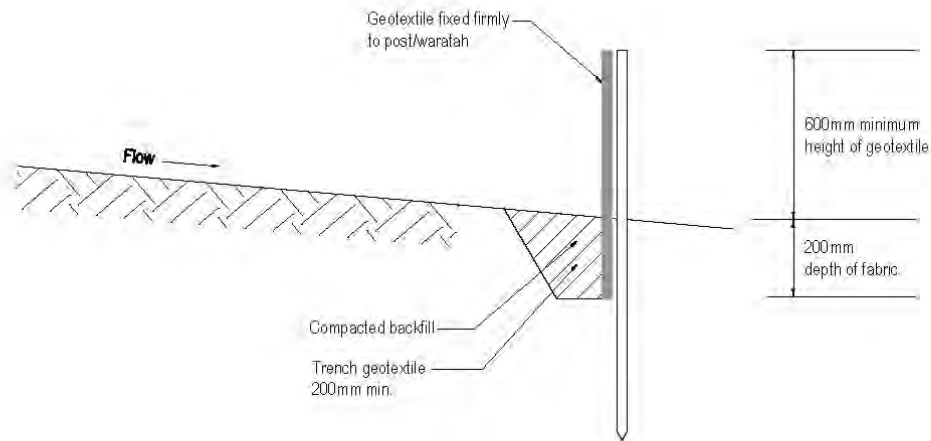

Cross section

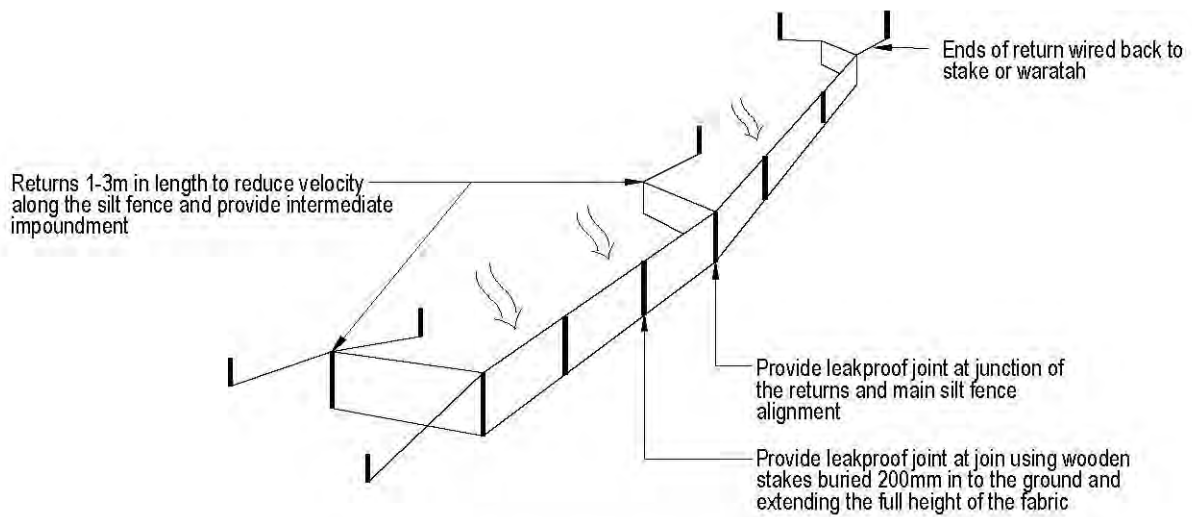
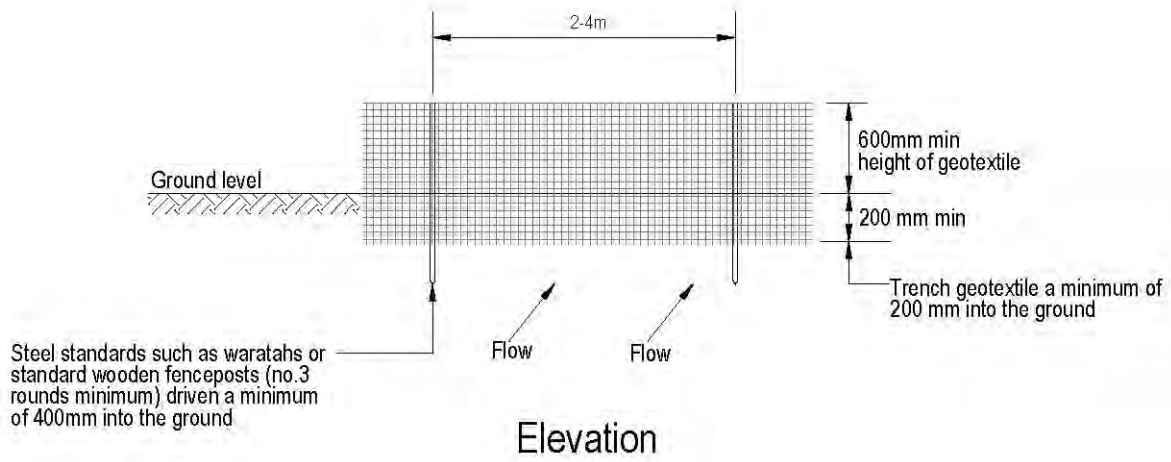

Silt fence with returns and support wire

Appendix C1.15 Super silt fence

Contractor:	Date: Time:	Consent #:	Site:
-------------	----------------	------------	-------

Construction checklist (refer Figure and table over page and Section F1.4 of GD05 for further details)	Yes (✓)	No (X) (Add comments to explain)
Super silt fence material used is appropriate to the site conditions and in accordance with the manufacturer's specifications		
Super silt fences are installed along the contour		
A trench of a minimum of 100 mm wide and 200 mm deep has been excavated along the proposed line of the silt fence		
Supporting posts /steel waratahs are installed at least 1.8 m length and 2–4 m apart		
Support posts/waratahs are installed on the down-slope edge of the trench, with silt fence fabric on the up-slope side of the support posts to the full depth of the trench. The trench is backfilled with compacted soil		
Tensioned galvanised wire (2.5 mmHT) is installed at 400 mm and again at 800 mm above ground. The wire has been tensioned using permanent wire strainers attached to angled waratahs at the end of the super silt fence		
Chain link fence is secured to the fence posts with wire ties or staples, ensuring the chain link fence goes to the base of the trench		
Two layers of geotextile fabric are secured to the base of the trench (a minimum of 200 mm into the ground), with compacted backfill installed to the original ground level		
Where ends of the silt fence fabric come together, they are overlapped, folded and stapled/screwed to prevent sediment bypass		

Note: The purpose of this checklist is for contractors to complete on-site self-checks of construction quality for ESC practices. This is not a compliance or as-built checklist.

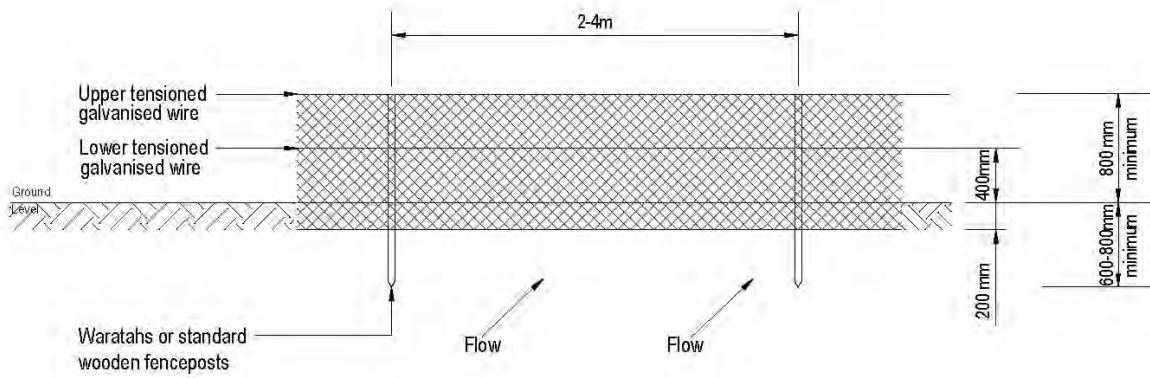

Elevation

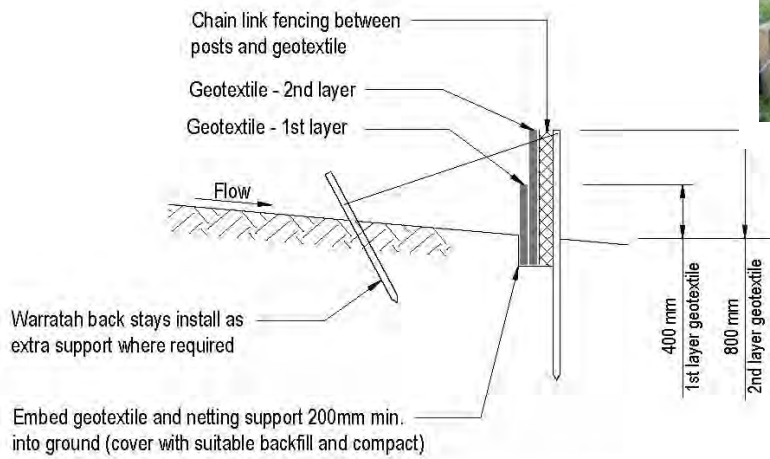

Cross - section

Slope steepness %	Slope length (m) (maximum)	Spacing of returns (m)	Super silt fence length (m) (maximum)
0 – 10%	Unlimited	60	Unlimited
10 – 20%	60	50	450
20 – 33%	30	40	300
33 – 50%	30	30	150
> 50%	N/A	20	N/A

Appendix C1.16 Silt sock

Contractor:	Date: Time:	Consent #:	Site:
-------------	----------------	------------	-------

Construction checklist (refer Figure below and Section F1.5 of GD05 for further details)	Yes (✓)	No (X) (Add comments to explain)
Silt socks are installed on the contour. Where this is not possible, or where there are long sections of silt sock, short silt sock returns are installed, projecting up-slope from the silt sock to minimise concentration of flows. Returns are a minimum of 2 m in length		
Silt socks are overlapped by >1 m and joined by a sleeve where more than one length of silt sock is used		
Silt sock "wings" are installed at either end of the silt sock, projecting a sufficient length up-slope to prevent outflanking		
The silt sock is pegged and secured, depending on the application		

Note: The purpose of this checklist is for contractors to complete on-site self-checks of construction quality for ESC practices. This is not a compliance or as-built checklist.



Appendix C1.17 Stormwater inlet protection

Contractor:	Date: Time:	Consent #:	Site:
-------------	----------------	------------	-------

Construction checklist (refer Figure below and Section F1.6 of GD05 for further details)	Yes (✓)	No (X) (Add comments to explain)
An emergency bypass is included		
The device does not allow water to bypass its intended flow path		
The device is removed as soon as possible following the completion of works		

Note: The purpose of this checklist is for contractors to complete on-site self-checks of construction quality for ESC practices. This is not a compliance or as-built checklist.



Appendix C1.18 Flocculant treatment - rainfall activated shed

Contractor:	Date: Time:	Consent #:	Site:
-------------	----------------	------------	-------

Construction checklist (refer Figure over page and Section F2.0 of GD05 for further details)	Yes (✓)	No (X) (Add comments to explain)
All components are on site including: <ul style="list-style-type: none"> • Rainfall catchment tray • Header tank • Displacement tank • Flocculant reservoir tank 		
The design approach has been followed – this should provide sizing of the various elements and pipe sizes. Check that the flocculant volume has been based on site soil testing		
Rainfall tray has been constructed and sealed along any joints and graded at approximately a 10:1 slope with a drain to the header tank at the low end		
The header tank is installed properly with pipe sizes and elevations done according to plans		
The displacement tank has capacity to hold runoff from the 50% AEP event		
The flocculant reservoir tank is larger than the displacement tank and of sufficient capacity to dose a large storm		
The flocculant tank outlet is a 20 mm hose located at the point that will retain flocculant for the dosing of runoff from the 50% AEP event w/out displacement		
The dosing point of the outlet into the sediment diversion channel is at least 5 m upstream of the forebay		

Note: The purpose of this checklist is for contractors to complete on-site self-checks of construction quality for ESC practices. This is not a compliance or as-built checklist.

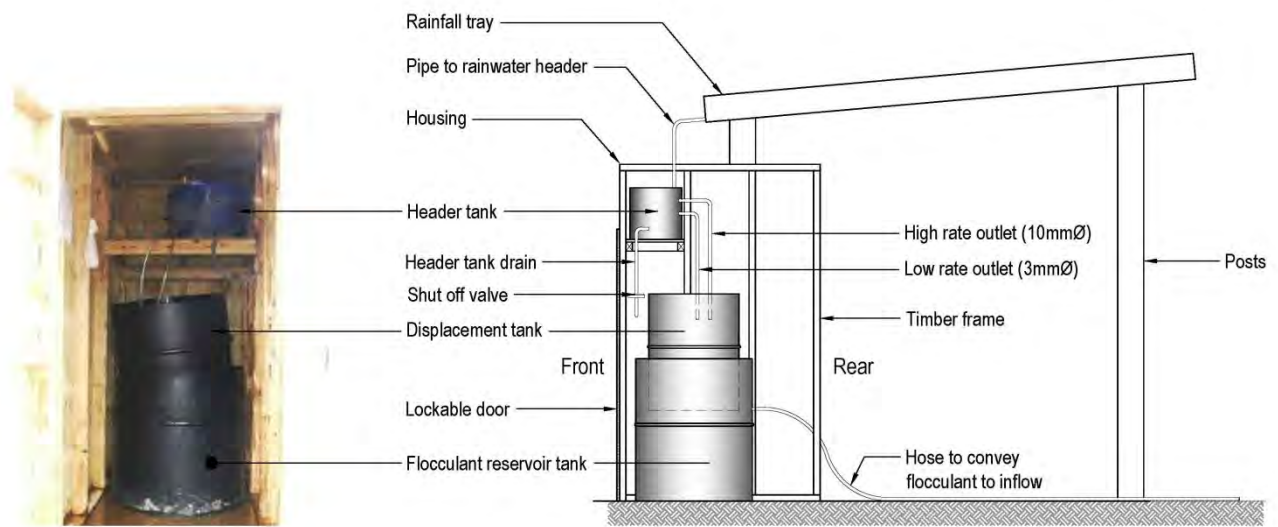

Appendix C1.19 Dewatering

Contractor:	Date: Time:	Consent #:	Site:
-------------	----------------	------------	-------

Construction checklist (refer Figure over page and Section G1.0 of GD05 for further details)	Yes (✓)	No (X) (Add comments to explain)
The cleaner water is always dewatered at the top first, then the residual sediment-laden water is pumped to a tank/truck		
The outlet to any pumped water is not creating any erosion issues. In some cases, an energy dissipater and a stabilised area may need to be constructed to discharge the pumped flows into		
The discharge is being monitored to ensure the pumped discharge is meeting the required discharge standards at all times		
A minimum of 100 mm water clarity is required to pump directly offsite. If there is not 100 mm water clarity, the water is either: <ul style="list-style-type: none"> • Treated <i>in situ</i> until the clarity is achieved and then pumped offsite • Pumped to a sediment retention device, tank or skip for settlement or flocculant treatment device before discharge offsite (Note: If pumping to a DEB or SRP, the outlet should be capped until it has been checked that 100 mm clarity has been achieved before the water is released) • Pumped to a tanker and removed offsite 		
Water is recycled wherever possible (e.g. for dust suppression or earthworks conditioning)		
Small volumes of sediment-laden water are pumped to a silt fence or decanting earth bund, but do not overwhelm these practices		
Larger volumes of sediment-laden water are pumped to a sediment forebay of a sediment retention pond		

Note: The purpose of this checklist is for contractors to complete on-site self-checks of construction quality for ESC practices. This is not a compliance or as-built checklist.

Appendix C1.20 Stream diversion















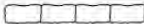
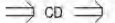















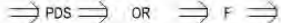



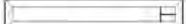

Contractor:	Date: Time:	Consent #:	Site:
-------------	----------------	---------------	-------

Construction checklist (refer Section G4.0 of GD05 for further details)	Yes (✓)	No (X) (Add comments to explain)
Stream diversion channel has the capacity to accommodate the 5% AEP		
Contingency measures in place if the diversion channel is exceeded/unable to be constructed to accommodate the 5% AEP		
Appropriately stabilised at grades >2%		
Non-erodible dam upstream and downstream		
Channel cross-section is parabolic and not V-shaped		
Consider fish passage (based on, season, duration and location of diversion etc.)		

Note: The purpose of this checklist is for contractors to complete on-site self-checks of construction quality for ESC practices. This is not a compliance or as-built checklist.

Appendix D1.0 Recommended line types and symbols

The following table includes recommended line types and symbols for use in ESC Plans. These are listed in alphabetical order.

Line type / ESC practice measure	Recommended symbol
Baffles	
Catchment boundary	
Check dam	
Clean water diversion bund	
Coffer dam	
Contour drain	
Decanting earth bund (not to scale)	
Dirty water diversion bund	
Earth bund	
Earthworks extent (approx)	
Existing boundaries	
Existing contours	
Existing watercourse	
Existing stormwater (pipe) reticulation	
Flow direction	
Geotextile	
Haul road centreline	
Hydro seeding	
Level spreader	
Mulching	
Permanent seeding	
Pipe drop structure / flume	
Proposed contours	
Proposed culvert	
Rain activated treatment system	
Rock rip-rap	
Sediment retention pond (drawn to scale)	
Silt fence	
Silt sock	
Stabilised entranceway	
Stormwater inlet protection	
Super silt fence	
Surface roughening	
Temporary seeding	
Temporary watercourse crossing	
Temporary watercourse diversion	
Top soiling	
Turfig	
Works within watercourse (area of works)	

Appendix E1.0 Site plan / drawing examples

This Appendix includes examples of ESC site plans/drawings that are considered best practice. It is recommended that the ESC site plan/drawing contains the following information:

- A title, date, drawing reference number, north arrow, scale and legend
- A unique identifier for each ESC control structure
- The areal extent of soil disturbance (earthworks footprint)
- The location of ESC devices, including volumes and dimensions where relevant
- The location of topsoil stockpiles
- Contributing catchments for each ESC device
- Identification of any 'no go' or buffer areas to maintain on the site
- Clearly marked areas of cut and fill (e.g. zerocut to fill line), including any soil disposal areas
- Arrows depicting the general flow path/direction of water within each catchment
- All watercourses and/or overland flow paths
- Historical/cultural/natural heritage sites
- Identification of any sensitive receiving environments
- Site entranceways
- Pond dimensions
- The site boundaries
- Contour lines – both within and around the site
- Staging (if applicable)
- High risk areas (if applicable)
- Aerial image (if available and clear without affecting readability of drawing)
- Any other relevant information.

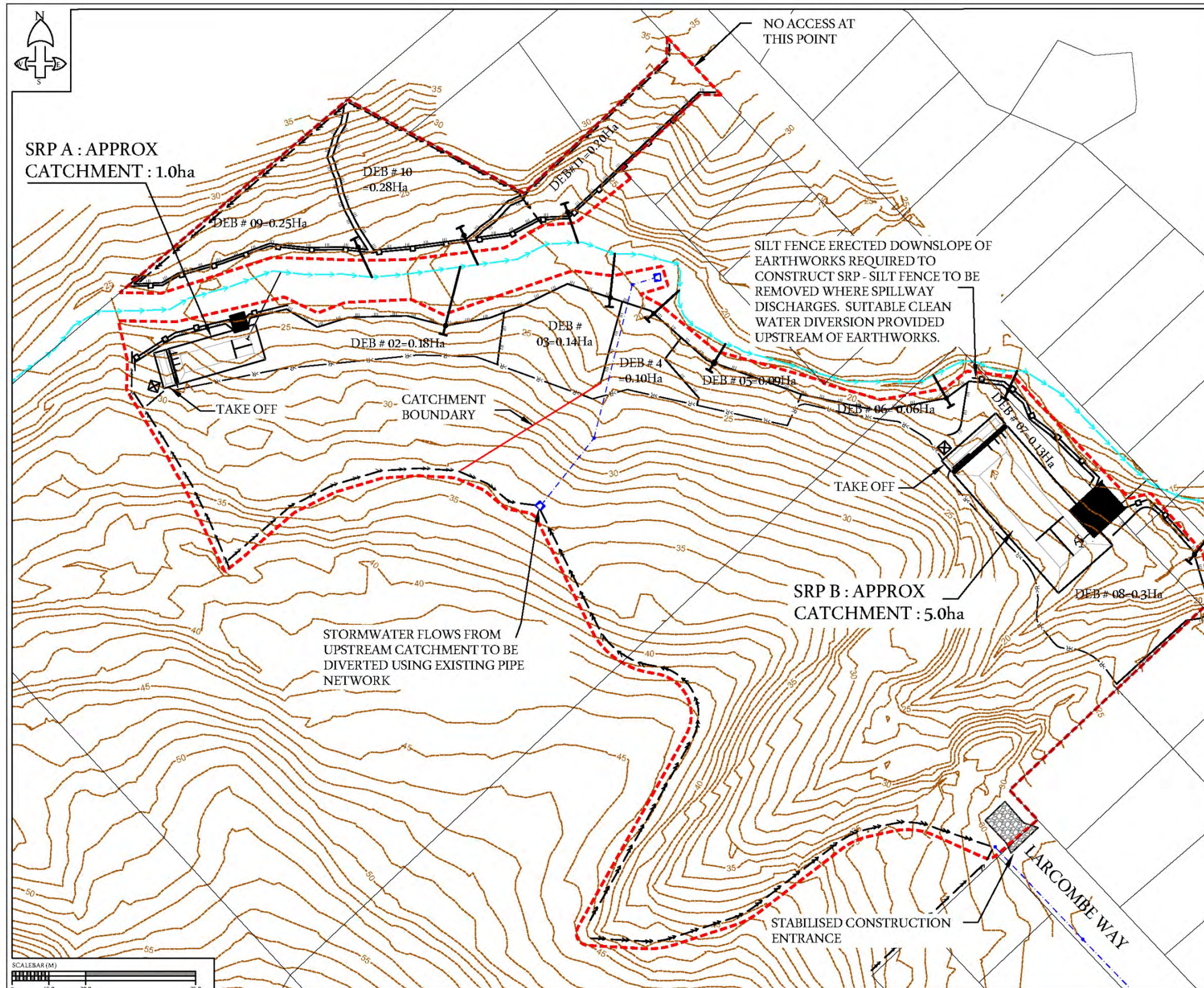

DESIGNER:	SCALE: 1:1500 @A3	
REVIEWER:		
2nd REVIEWER:		
PROJECT No:		
PLAN TITLE: EROSION & SEDIMENT CONTROL PLAN		
PLAN REFERENCE: ABE 15-00020	VERSION:	
AMENDMENTS:	NAME	DATE
ISSUED FOR APPROVAL	JS	15/5/19

LEGEND

EXISTING CONTOURS	
EXISTING WATERCOURSE	
APPROXIMATE EXTENT OF EARTH WORKS	
EXISTING BOUNDARIES	
SEDIMENT RETENTION POND	
RAIN ACTIVATED DOSING SYSTEM	
DIRTY WATER DIVERSION BUND	
CLEAN WATER DIVERSION BUND	
EARTH BUND	
SILT FENCE	
T BAR DECANTING EARTH BUND	
EXISTING STORMWATER (PIPE) RETICULATION	
CATCHMENT BOUNDARY	

- NOTES**
1. ALL EROSION AND SEDIMENT CONTROL MEASURES ARE TO COMPLY WITH GD05.
 2. BEFORE COMMENCING WORKS THE CONTRACTOR SHALL ENSURE THAT THEY HAVE A COPY OF THE RESOURCE CONSENT FROM THE ENGINEER.
 3. ANY MODIFICATIONS TO THE CONSENTED EROSION AND SEDIMENT CONTROL DRAWING MUST BE APPROVED BY THE AUCKLAND COUNCIL PRIOR TO CONSTRUCTION.
 4. THE EXTENT OF AREAS TO BE WORKED ARE TO BE CLEARLY IDENTIFIED AND ALL EROSION AND SEDIMENT CONTROL MEASURES IN PLACE AND APPROVED BEFORE EARTHWORKS COMMENCE.
 5. ALL SEDIMENT RETENTION PONDS ARE TO INCLUDE A RAIN ACTIVATED DOSING SYSTEM, DESIGNED SPECIFICALLY FOR THE SITE.
 6. MAINTENANCE OF THE EROSION AND SEDIMENT CONTROL MEASURES IS THE SOLE AND EXCLUSIVE RESPONSIBILITY OF THE PRIMARY EARTHMOVING CONTRACTOR.
 7. CONTOUR DRAINS ARE TO BE INSTALLED AT 30m SPACING AND BE PROVIDED AT THE END OF EACH DAY.
 8. ALL DEBs ARE TO HAVE A MINIMUM VOLUME OF 2% OF THE CONTRIBUTING CATCHMENT AREA AND CONSTRUCTED TO COMPLY WITH GD05 DESIGN CRITERIA.



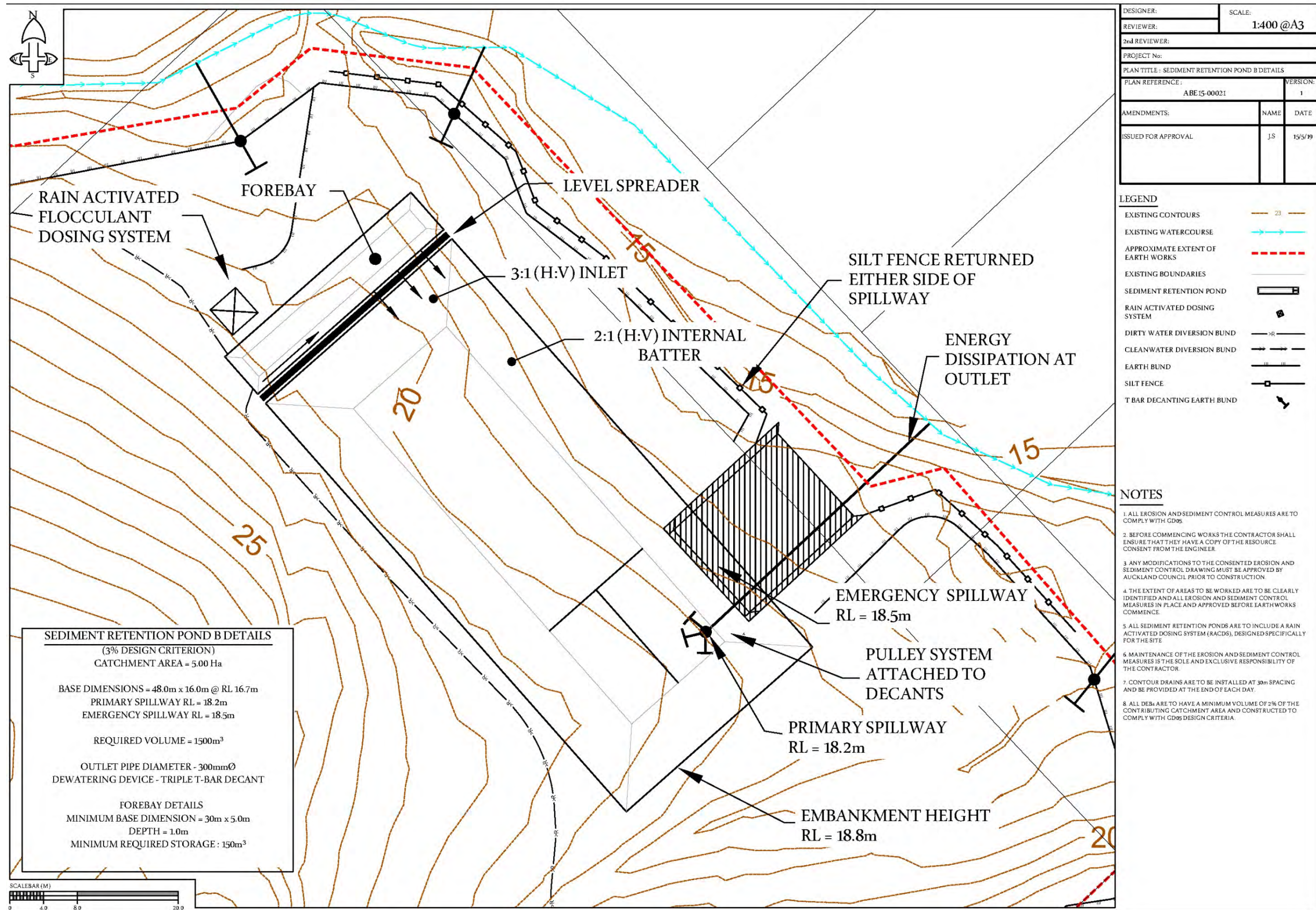

DESIGNER:	SCALE:
REVIEWER:	1:400 @A3
2nd REVIEWER:	
PROJECT No:	
PLAN TITLE: SEDIMENT RETENTION POND B DETAILS	
PLAN REFERENCE:	VERSION:
ABE 15-00021	1
AMENDMENTS:	NAME DATE
ISSUED FOR APPROVAL	JS 15/5/19

LEGEND

EXISTING CONTOURS	
EXISTING WATERCOURSE	
APPROXIMATE EXTENT OF EARTH WORKS	
EXISTING BOUNDARIES	
SEDIMENT RETENTION POND	
RAIN ACTIVATED DOSING SYSTEM	
DIRTY WATER DIVERSION BUND	
CLEANWATER DIVERSION BUND	
EARTH BUND	
SILT FENCE	
T BAR DECANTING EARTH BUND	

- NOTES**
1. ALL EROSION AND SEDIMENT CONTROL MEASURES ARE TO COMPLY WITH GD95.
 2. BEFORE COMMENCING WORKS THE CONTRACTOR SHALL ENSURE THAT THEY HAVE A COPY OF THE RESOURCE CONSENT FROM THE ENGINEER.
 3. ANY MODIFICATIONS TO THE CONSENTED EROSION AND SEDIMENT CONTROL DRAWING MUST BE APPROVED BY AUCKLAND COUNCIL PRIOR TO CONSTRUCTION.
 4. THE EXTENT OF AREAS TO BE WORKED ARE TO BE CLEARLY IDENTIFIED AND ALL EROSION AND SEDIMENT CONTROL MEASURES IN PLACE AND APPROVED BEFORE EARTHWORKS COMMENCE.
 5. ALL SEDIMENT RETENTION PONDS ARE TO INCLUDE A RAIN ACTIVATED DOSING SYSTEM (RACDS), DESIGNED SPECIFICALLY FOR THE SITE.
 6. MAINTENANCE OF THE EROSION AND SEDIMENT CONTROL MEASURES IS THE SOLE AND EXCLUSIVE RESPONSIBILITY OF THE CONTRACTOR.
 7. CONTOUR DRAINS ARE TO BE INSTALLED AT 30m SPACING AND BE PROVIDED AT THE END OF EACH DAY.
 8. ALL DEBs ARE TO HAVE A MINIMUM VOLUME OF 2% OF THE CONTRIBUTING CATCHMENT AREA AND CONSTRUCTED TO COMPLY WITH GD95 DESIGN CRITERIA.

SEDIMENT RETENTION POND B DETAILS
 (3% DESIGN CRITERION)
 CATCHMENT AREA = 5.00 Ha

BASE DIMENSIONS = 48.0m x 16.0m @ RL 16.7m
 PRIMARY SPILLWAY RL = 18.2m
 EMERGENCY SPILLWAY RL = 18.5m

REQUIRED VOLUME = 1500m³

OUTLET PIPE DIAMETER - 300mmØ
 DEWATERING DEVICE - TRIPLE T-BAR DECANT

FOREBAY DETAILS
 MINIMUM BASE DIMENSION = 30m x 5.0m
 DEPTH = 1.0m
 MINIMUM REQUIRED STORAGE: 150m³

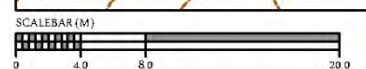

Appendix F1.0 Bench testing methodology

This appendix describes the process of undertaking bench testing of liquid coagulants and flocculants. The most commonly used coagulant used in New Zealand is polyaluminium Chloride (PAC) and the most common form of flocculants in New Zealand are polymer-based as PAC.

Bench testing is the process of trialling different chemicals, or the same chemical at different concentrations, to optimise the effectiveness of dropping out sediment while minimising the concentration required. This minimises the cost of the chemical and any potential impacts downstream from over dosing.

The output of the bench testing is the optimal amount of chemical (mg) to be applied per unit volume of sediment-laden water (L), known as the dose (mg/L). The concentration derived from the bench testing is then used on site to calibrate the dose rate. This is site-specific and dependant on rate and concentration of sediment-laden runoff from the site.

A bench test is required:

- For each representative soil type in the catchment contributing to a sediment retention device
- Any time batch-dosing is required
- Any time chemical treatment is to be considered
- Whenever previous chemical treatment is no longer providing adequate results.

This methodology is based on liquid PAC and is not applicable to solid flocculants. Contact Auckland Council for advice on testing and using solid flocculants.

Appendix F1.1 Step 1: Collect the soil sample

The soil sample must be representative of the catchment soil (excluding topsoil and organics). If different soils are present in the catchment then a bench test is required for each soil type. Note, fill areas will require a mixture of cut soils to be tested where a combination of soils may be deposited. If a different soil type is exposed during earthworks then another sample of that soil must be bench tested.

- 1) Collect at least 2 kg of soil using a shovel or hand trowel. This will allow several bench tests to be undertaken with different flocculants.
- 2) Remove any large inconsistent material by hand.
- 3) Check the consistency of the soil. The soil should not be dry or sodden but should be malleable by hand (able to be squeezed or rolled).

Appendix F1.2 Step 2: Making the soil slurry

- 1) Weigh out 1 kg of the soil sample.
- 2) Add the soil to 1 L of water and mix into a slurry. Break up any clumps by hand.
- 3) Add 19 L of rainwater to make a total volume of 20 L.
- 4) Stir the soil/water mixture for three minutes to ensure an even suspension of sediment in the water. Ideally this should achieve a turbidity range of between 2000 – 3000 NTU. Note, this will depend on soil type; for example, with sandy soils a lower turbidity range might be expected.

Appendix F1.3 Step 3: Setting up the bench test jars

PAC is supplied with varying concentrations of active ingredients. Confirmation should be sought by the purchaser to confirm the supply of the PAC meets the New Zealand standards for supply. These standards should be confirmed by the supplier with a certificate of compliance at the commencement of the contract and thereafter at three monthly intervals or as agreed between purchaser and supplier.

The standard for PAC is defined by Water New Zealand ‘*Standard for the supply of polyaluminium chloride for use in water treatment*’, 2013, Second Edition, and the New Zealand Drinking Water Standard (2008).

Standard liquid PAC should have the following physical and chemical properties:

- Liquid PAC shall be a nearly saturated solution of PAC and it shall have not greater than 0.2% precipitated material present in the solution
- It shall contain water-soluble aluminium of not less than 2.16% w/w as Al or 10% w/w as Al₂O₃
- In liquid PAC, the water-insoluble matter shall not exceed 0.2% w/w.

Property	Form of Polyaluminium chloride
	Liquid*
pH of solution	2.6 ± 0.3
Specific gravity	1.2 (at 10.1% Al ₂ O ₃ or 5.3% as Al)

*Figures are given for a 34% w/w solution of PAC

Source: Standard for the supply of PAC (Water New Zealand).

The supplier shall confirm that their product meets the standard.

There are various recognised ways of determining the dose rate to be used in bench testing; the following provides an example of one method.

The concentration of commercially supplied liquid PAC is too high to be practically used for bench testing. The volumes of concentrated PAC to be added to the 1 L bench test jars are too small to measure accurately. Therefore, the concentrated PAC is diluted to prepare a stock solution so that the volume applied to the test jars can be measured with standard laboratory equipment.

To achieve this dilution, create a 1% v/v solution of the PAC product using 1 part PAC with 99 parts water e.g. 1ml of PAC to 99 mL of water.

The table below shows the volumes of a 1% v/v solution of PAC to be added to achieve desired aluminium concentration values.

Table 19: Flocculant concentrations (aluminium) for various volumes of PAC

Flocculant test jar	Concentration (mg of Al/L)	Concentration (Parts of Al per million, ppm)	Volume of 1% solution (ml)
0	0 (control)	0	0
1	1 mg/L	1 ppm	1.56
2	2 mg/L	2 ppm	3.1
3	4 mg/L	4 ppm	6.2
4	6 mg/L	6 ppm	9.4
5	8 mg/L	8 ppm	12.5
6	10 mg/L	10 ppm	15.6

Using seven identical jars, with a minimum of 1 litre capacity and a minimum of 150 mm in height, add the varying concentrations of chemical as outlined in Table 19. Note that minimum 150 mm tall jars are required to perform clarity tests in Step 5 below.

Appendix F1.4 Step 4: Adding sediment-laden water to bench test jars

- 1) Make sure the 20 L sample of sediment-laden water is continuously stirred and not allowed to settle.
- 2) If settling occurs, stir the solution for at least three minutes to re-suspend.
- 3) Decant 1 L of sediment-laden water to each labelled bench test jar.
- 4) Add 1% PAC solution at various concentrations as per table above.
- 5) Stir the 1 L jar to mix the solution with the water sample.
- 6) Allow the 1 L jars to sit undisturbed throughout the testing.

Appendix F1.5 Step 5: Measuring test results

Each of the test jars must have clarity tested at the following time intervals:

- 0 min
- 30 min
- 60 min.

The pH and turbidity (NTU) should be tested on the control at the beginning of the test and on all samples after 60 minutes.

Measurements:

- pH should be measured using a calibrated pH probe. Do not use litmus paper
- Clarity should be measured using a secchi disc (30 mm diameter). The secchi disc is mounted on a line and lowered slowly down into the water (while avoiding resuspension). When the disk is no longer visible, raise the disk to the point when it becomes visible again. Record this depth as the clarity, to the nearest 5 mm. Slowly retrieve the secchi disk to avoid resuspension
- NTU should be measured using a calibrated turbidity meter.

Appendix F1.6 Step 6: Interpreting test results

The aim of the test is to determine the most appropriate chemical at the most appropriate dosage. Therefore, the results should be interpreted by finding the chemical that provides the best sedimentation, with minimal change in pH (acceptable pH range 5.5 – 8.5), in the fastest time and lowest dose.

Several bench tests with different chemicals may be required to determine the optimum water quality improvement outcome. Note that PAC is the only product that has undergone rigorous testing by Auckland Council. The use of other chemicals may require specific Auckland Council approval.

An example of potential test results is provided in Figure 136. In this instance, a concentration of 6 mg/L was found to be optimal.

Table 20: Examples of test results from bench testing

Aluminium concentration (mg/L)	Clarity (mm) after 5 mins	Clarity (mm) after 30 mins	Clarity (mm) after 60 mins	Final pH after 60 mins	Final turbidity after 60 mins (NTU)
0	25	30	30	7.92	360
2	35	50	50	7.88	204
4	80	85	90	7.69	69
6	80	85	105	7.51	53
8	85	95	110	7.06	54
10	95	95	110	6.58	61

The aim of the bench testing is to try and achieve a minimum clarity of 100 mm during the test period. It is noted that with some soil types this might not be achievable.

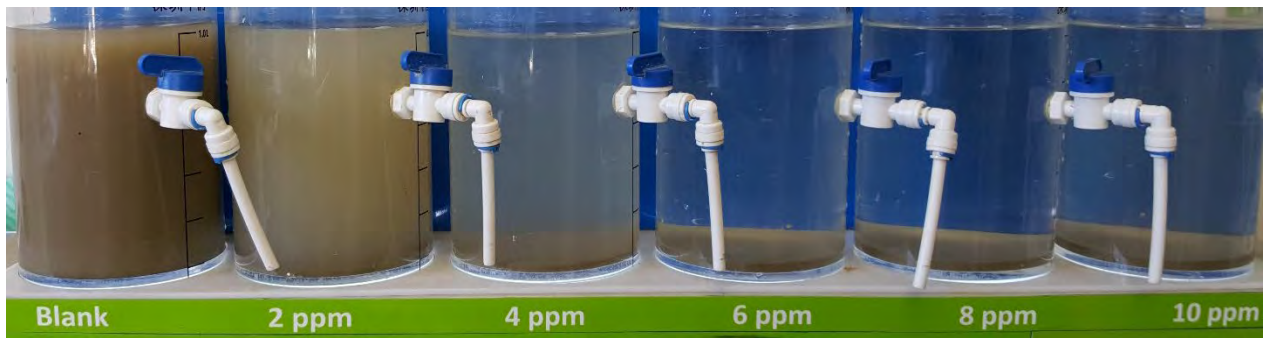

Figure 136: Example of test results from bench testing

Appendix F1.7 Step 7: Submitting test results

Auckland Council is committed to improving the understanding and processes of chemical application across industry. In order to do this, all test results should be submitted to Auckland Council as part of the Erosion and Sediment Control Plan or project's Chemical Treatment Plan.

